

ALBION®

the caster experts

// www.AlbionCasters.com



INDUSTRIAL HEAVY-DUTY CASTERS



U.S. ENGINEERING & MANUFACTURING // ERGONOMIC & SAFETY EXPERTS // INDUSTRY LEADING SELECTION

Download
3D CAD Models!

See Back Cover



ALBION®

the caster experts

www.albioncasters.com or 800.835.8911

Aerospace & Defense • Automotive • Food & Beverage
 Material Handling • Transportation • Packaging
 Pharmaceutical & Chemical • Institutional Equipment
 Marine • Agricultural • Warehouse & Distribution

HEAVY-DUTY & MATERIAL HANDLING EXPERTS
 For over 70 years, Albion has remained dedicated to solving industrial mobility challenges for customers around the world. Leveraging our industry proven experience and manufacturing technology – Albion offers the most complete lineup of industrial caster and wheel products, coupled with cutting-edge design capabilities to solve even the toughest application challenges. Contact us today to start a conversation and let us help specify the right caster for your specific application and performance requirements.

THE ALBION ADVANTAGE

YOUR SOURCE FOR TRUSTED INDUSTRIAL CASTERS AND WHEELS

■ ERGONOMIC EXCELLENCE

Albion is committed to making you more efficient and safer by easing the load of moving equipment throughout your facility. Long before ergonomics was popular, we were developing casters and wheels to reduce push/pull force and ease maneuverability.



See more on page 14.

■ POLYURETHANE EXPERTS

Polyurethane tread wheels provide durable mobility capable of rejecting floor debris, enhancing ergonomics, protecting floors, and even absorbing shock. Albion offers the most expansive lineup of polyurethane wheels, available in a wide array of durometers, face types, colors and thicknesses.



See more on page 15.

■ CUSTOM SOLUTIONS

Albion is happy to partner with you when an off-the-shelf product does not meet your application requirements. We have the engineering expertise and technology to bring your custom mobility needs to life on-time and on-budget.



See more on page 16-17.



With our proven design and manufacturing experience, we guarantee select Albion casters with up to a three (3) year warranty from date of purchase; look for the 3 year warranty icon throughout the catalog. All other Albion brand casters feature a (1) year warranty from date of purchase.

Visit albioncasters.com/warranty for official warranty details.

■ CATALOG TOOLBOX

Look for these helpful icons located throughout the catalog designating key features and application benefits.



USA Made

If you want quality and pride associated with USA manufactured products, look for this symbol.



Premium Quality

The best Albion has to offer. Enough Said!



Heat Resistant

Product is rated for high temperatures. Please note: for intermittent temperatures always consult factory.



Maintenance Free

Bearing does not require regular greasing to perform to standard.



Environmentally Friendly

Complies with RoHS regulations as set forth by the European Union.



NSF Rated

Many Albion casters are NSF listed for use in the food & beverage industries. Look under Features in each series for qualifying products.



Stainless Steel

Constructed of stainless steel to withstand the most abusive conditions—steam cleaning, wash downs, solvents, chemicals and acids.



Economical

For budget driven projects. Albion offers good, better, best throughout our offering!



Ergonomic

Exceptional rollability, manual pushing requires little effort.



Towing

Rig specifically designed for towing applications; consult factory before ordering to ensure wheel and bearing are properly specified for all power towed applications. (Towing recommendation based on average speed of 3-5mph; consult factory for higher speeds.)

A LEADING BRAND OF



THE GLOBAL LEADER IN CASTERS AND WHEELS

- The **industry leader** and **most complete product** offering in the world
- The **highest value** for your caster dollar
- **One-stop shopping** for nearly any application and budget
- The **most experienced** engineering, sales, manufacturing, and quality teams
- **Local service worldwide**, ready for any business need

MANUFACTURING



With advanced manufacturing and distribution facilities located around the world, we continuously invest in our proprietary supply chain and leading portfolio of USA Made casters to provide the best value to our customers.

ENGINEERING



Utilizing the latest in available technologies, Colson Group USA's global design and engineering teams ensure every detail in product performance, materials, and aesthetics are delivered to meet and exceed industry and customer expectations.

SERVICE



Delivering truly one-stop shopping, our experienced inside and outside support teams help customers identify the right caster from our leading product portfolio to ensure your expectations and business requirements are met on every order.

QUALITY



As an active ICWM member, we help define industry testing standards (ANSI ICWM: 2012). Leading test labs and global quality systems confirm our casters meet stringent quality standards, allowing up to a 3-year standard warranty on select series.



Download 3D CAD Models and Datasheets!

- **Quickly configure** models
- Download **native CAD formats**
- Download **datasheets**
- **Easily share** with your team

Online: AlbionCasters.com/CAD
App: Search "Caster CAD 3D"

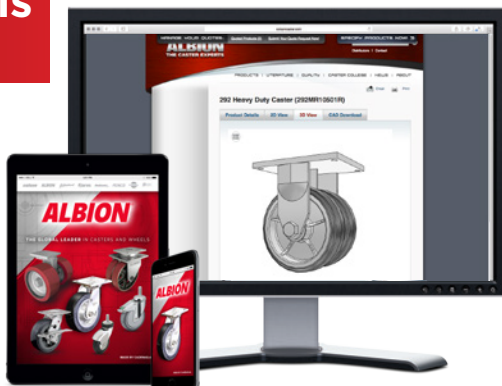

QUICK-START PRODUCT CATEGORIES

Full Visual Table of Contents
Follows on Next Pages >>



2" WIDE MEDIUM HEAVY DUTY
(up to 2,000 lbs.)

PAGES

23-39



HEAVY DUTY KINGPINLESS & KINGPIN
(up to 20,000 lbs.)

PAGES

41-74



STAINLESS STEEL
(up to 3,000 lbs.)

PAGES

75-86



SPRING LOADED
(up to 3,000 lbs.)

PAGES

87-99



DUAL WHEELS
(up to 30,000 lbs.)

PAGES

100-112

PNEUMATIC
(up to 7,260 lbs.)



PAGES

113-117

Light Duty

PAGES: 19-22

Page
20-21



02 SERIES INSTITUTIONAL CASTERS

Tread Width: 1-1/4"
Capacity: Up to 350 lbs.

Wheel Diameters: 3", 3-1/2", 4", 5", 6"
Brake: Grip Lock, Face Contact, Total Lock

Page
22



P2 SERIES PRECISION CASTERS

Tread Width: 1-1/4"
Capacity: Up to 250 lbs.

Wheel Diameters: 3", 3-1/2", 4", 5"
Brake: Face Contact, Total Lock

Medium Heavy Duty

PAGES: 23-34

Page
24-26



16 SERIES CASTERS

Tread Width: 2" (1-1/2" – 1-7/8" options)
Capacity: Up to 1250 lbs.

Wheel Diameters: 3-1/4", 4", 5", 6", 8"
Brake: Total Lock, Grip Lock, Cam, Face, Single/Double Sided, Poly Cam, Swivel Lock

Page
27-29



62 SERIES CASTERS

Tread Width: 2", 2-1/2"
Capacity: Up to 1500 lbs.

Wheel Diameters: 4", 5", 6", 8", 10"
Brake: Single Sided/Double Sided, Face, Cam, Poly Cam, Swivel Lock

Page
30



63 SERIES CASTERS

Tread Width: 2", 2-1/2"
Capacity: Up to 2000 lbs.

Wheel Diameters: 5", 6", 8", 10", 12"
Brake: Face Contact, Face, Poly Cam, Single Sided/Double Sided, Swivel Lock

Page
31-32



71 SERIES CASTERS

Tread Width: 2" (1-1/2" – 2-3/16" options)
Capacity: Up to 1500 lbs.

Wheel Diameters: 3-1/4", 4", 5", 6", 8"
Brake: Cam, Face, Single Sided/Double Sided, Poly Cam, Swivel Lock,

Page
33-34



72 SERIES CASTERS

Tread Width: 2", 2-1/2" (1-3/4" options)
Capacity: Up to 1600 lbs.

Wheel Diameters: 4", 5", 6", 8", 10"
Brake: Cam, Face Brake, Single Sided/Double Sided, Poly Cam, Swivel Lock

Maintenance Free Medium Heavy Duty

PAGES: 35-40

Page
36-37



18 SERIES ERGONOMIC PRECISION CASTERS

Tread Width: 1-1/2", 2"
Capacity: Up to 1250 lbs.

Wheel Diameters: 3-1/4", 4", 5", 6", 8"
Brake: Face, Swivel Lock

Page
38-39



68 SERIES KINGPINLESS CASTERS

Tread Width: 2"
Capacity: Up to 2000 lbs.

Wheel Diameters: 6", 8"
Brake: Not Applicable

Heavy Duty Kingpinless

PAGES: 41-58

Page
42-44



110 CONTENDER SERIES CASTERS

Tread Width: 2" (1-1/2" – 1-7/8" options)
Capacity: Up to 2000 lbs.

Wheel Diameters: 4", 5", 6", 8"
Brake: Cam, PLB, Face, Single Sided/Double Sided, Poly Cam, Swivel Lock

Page
46-47



170 SERIES CASTERS

Tread Width: 2"
Capacity: Up to 1500 lbs.

Wheel Diameters: 4", 5", 6", 8"
Brake: Cam, Single/Double Sided, Face, Swivel Lock

Page
48-49



310 CONTENDER SERIES CASTERS

Tread Width: 2-1/2", 3"
Capacity: Up to 4100 lbs.

Wheel Diameters: 6", 8", 10", 12"
Brake: Poly Cam, PLB, Single/Double Sided, Face Contact, Swivel Lock

Page
50-51



410 CONTENDER SERIES CASTERS

Tread Width: 2-1/2", 3"
Capacity: Up to 5400 lbs.

Wheel Diameters: 6", 8", 10", 12"
Brake: Poly Cam, PLB, Single/Double Sided, Face Contact, Swivel Lock

Page
52-53



610 CONTENDER SERIES CASTERS

Tread Width: 2-1/2", 3", 3-1/2", 4"
Capacity: Up to 9500 lbs.

Wheel Diameters: 6", 8", 10", 12", 14"
Brake: Poly Cam, PLB, Single/Double Sided, Swivel Lock

Page
54-55



600 SHOCKMASTER SERIES CASTERS

Tread Width: 2-1/2", 3", 3-1/2", 4"
Capacity: Up to 10000 lbs.

Wheel Diameters: 6", 8", 10", 12"
Brake: Poly Cam, PLB, Single/Double Sided, Face Contact, Swivel Lock

Page
56-57



700 SHOCKMASTER SERIES CASTERS

Tread Width: 4", 5", 6"
Capacity: Up to 20000 lbs.

Wheel Diameters: 8", 10", 12", 16"
Brake: Poly Cam, PLB, Face Contact, Swivel Lock

Heavy Duty Kingpin

Pages: 59-74

Page
60-61



81 SERIES CASTERS

Tread Width: 2-1/2", 3", 3-1/4"
Capacity: Up to 2000 lbs.

Wheel Diameters: 3-1/4", 4", 5", 6", 8", 10", 12"
Brake: Poly Cam, Single/Double Sided, Face Contact, Wrap Around, Face, Swivel Lock

Page
62-63



90 SERIES CASTERS

Tread Width: 2-1/2", 3", 3-1/4", 4", 4-1/4"
Capacity: Up to 3500 lbs.

Wheel Diameters: 3-1/4", 4", 5", 6", 8", 10", 12"
Brake: Poly Cam, Single/Double Sided, Face Contact, Wrap Around, Face, Swivel Lock

Page
64-65



92 SERIES CASTERS

Tread Width: 3", 3-1/2", 4"
Capacity: Up to 4800 lbs.

Wheel Diameters: 8", 10", 12"
Brake: Poly Cam, Single/Double Sided, Face Contact, Wrap Around, Face, Swivel Lock

Page
66



93 SERIES CASTERS

Tread Width: 3", 3-1/2", 4", 5"
Capacity: Up to 7500 lbs.

Wheel Diameters: 12", 16", 18"
Brake: Poly Cam, Face Contact, Swivel Lock

Page
68-71



94 SERIES (BBL/TRL) CASTERS

Tread Width: 2-1/2", 3", 3-1/2", 4"
Capacity: Up to 10000 lbs.

Wheel Diameters: 6", 8", 10", 12"
Brake: Poly Cam, Single/Double Sided, Face Contact, Wrap Around, Swivel Lock

Page
72-74



95 SERIES (BBL/TRL) CASTERS

Tread Width: 2-1/2", 3", 3-1/2", 4", 5", 6"
Capacity: Up to 17000 lbs.

Wheel Diameters: 6", 8", 10", 12", 16"
Brake: Poly Cam, Face Contact, Swivel Lock

Stainless Steel

Pages: 75-86

Page
77



04 SERIES CASTERS

Tread Width: 1-1/4"
Capacity: Up to 350 lbs.

Wheel Diameters: 3", 3-1/2", 4", 5"
Brake: Grip Lock, Face Contact

Page
78-79



05 SERIES CASTERS

Tread Width: 2"
Capacity: Up to 1200 lbs.

Wheel Diameters: 4", 5", 6", 8"
Brake: Cam, Face, Swivel Lock

Page
80-81



120 SERIES CONTENDER KINGPINLESS CASTERS

Tread Width: 2"
Capacity: Up to 1200 lbs.

Wheel Diameters: 4", 5", 6", 8"
Brake: Single/Double Sided, Face, Swivel Lock

Page
84



330 SERIES CONTENDER KINGPINLESS CASTERS

Tread Width: 2-1/2", 3"
Capacity: Up to 3000 lbs.

Wheel Diameters: 6", 8", 10", 12"
Brake: Poly Cam, PLB Integrated, Single/Double Sided, Swivel Lock

Page
85-86



E5 SERIES ECONOMY CASTERS

Tread Width: 2"
Capacity: Up to 900 lbs.

Wheel Diameters: 4", 5", 6", 8"
Brake: Cam, Face, Swivel Lock

Spring Loaded

Pages: 87-99

Page
88-89



40 SERIES MEDIUM DUTY KINGPIN CASTERS

Tread Width: 2"
Capacity: Up to 500 lbs.

Wheel Diameters: 5", 6", 8"
Brake: Single/Double Sided, Swivel Lock

Page
90



41 SERIES SPRINGGUARD™ SPRING-LOADED KINGPIN CASTERS

Tread Width: 2"
Capacity: Up to 800 lbs.

Wheel Diameters: 6"
Brake: Consult Factory

Page
91



42 SERIES HEAVY DUTY KINGPIN CASTERS

Tread Width: 2-1/2"
Capacity: Up to 800 lbs.

Wheel Diameters: 8", 10"
Brake: Single/Double Sided, Swivel Lock

>> Spring Loaded Continues on Next Page >>

CONTENTS

CONTINUED ON NEXT PAGES

Page
92



44 SERIES XTRA HEAVY DUTY SPRING-LOADED KINGPIN CASTERS

Tread Width: 2-1/2", 3", 4", 5"
Capacity: Up to 1500 lbs.

Wheel Diameters: 10", 12", 14", 16"
Brake: Single/Double Sided, Swivel

Page
93



141 SERIES CONTENDER KINGPINLESS POLY SPRING CASTERS

Tread Width: 2"
Capacity: Up to 1500 lbs.

Wheel Diameters: 5", 6", 8"
Brake: Not Applicable

Page
94-95



S310 SERIES CONTENDER SPRING LOADED KINGPINLESS CASTERS

Tread Width: 2-1/2", 3"
Capacity: Up to 3000 lbs.

Wheel Diameters: 6", 8", 10", 12"
Brake: Not Applicable

Page
96-97



S410 SERIES CONTENDER SPRING LOADED KINGPINLESS CASTERS

Tread Width: 2-1/2", 3"
Capacity: Up to 3000 lbs.

Wheel Diameters: 6", 8", 10", 12"
Brake: Not Applicable

Page
98-99



S610 SERIES CONTENDER SPRING LOADED KINGPINLESS CASTERS

Tread Width: 2-1/2", 3"
Capacity: Up to 3000 lbs.

Wheel Diameters: 6", 8", 10", 12"
Brake: Not Applicable

Dual Wheel

Page
101-102



216/263 SERIES CANTILEVER-STYLE CASTERS

Tread Width: 1-1/2", 2"
Capacity: Up to 2000 lbs.

Wheel Diameters: 3-1/4", 4", 5", 6", 8"
Brake: Not Applicable

Page
103



281 SERIES CANTILEVER-STYLE CASTERS

Tread Width: 2-1/2"
Capacity: Up to 2000 lbs.

Wheel Diameters: 6", 8", 10", 12"
Brake: Not Applicable

Page
104



290/295 SERIES CANTILEVER-STYLE CASTERS

Tread Width: 3", 3-1/2", 4"
Capacity: Up to 8000 lbs.

Wheel Diameters: 8", 10", 12"
Brake: Not Applicable

Page
105



115 SERIES KINGPINLESS CASTERS

Tread Width: 2"
Capacity: Up to 2000 lbs.

Wheel Diameters: 4", 5", 6", 8"
Brake: Not Applicable

Page
106



315 SERIES KINGPINLESS CASTERS

Tread Width: 2", 3"
Capacity: Up to 4100 lbs.

Wheel Diameters: 6", 8", 10", 12"
Brake: PLB Integrated, Swivel Lock, Toe Guard

Page
107



415/615 SERIES KINGPINLESS CASTERS

Tread Width: 3", 3-1/2", 4", 5"
Capacity: Up to 12000 lbs.

Wheel Diameters: 6", 8", 10", 12"
Brake: PLB Integrated, Swivel Lock, Toe Guard

Page
108



850 SERIES KINGPINLESS CASTERS

Tread Width: 3", 4", 4-1/2", 5", 6", 9"
Capacity: Up to 30000 lbs.

Wheel Diameters: 6", 10", 12", 16", 18"
Brake: Face Contact, Swivel Lock

Page
109



272/281 SERIES KINGPIN CASTERS

Tread Width: 1-1/2", 1-5/8", 1-3/4", 2"
Capacity: Up to 12000 lbs.

Wheel Diameters: 3-1/4", 4", 5", 6", 8"
Brake: Not Applicable

Page
110



290/292/293 SERIES KINGPIN CASTERS

Tread Width: 2-1/2", 3", 3-1/2", 4", 5"
Capacity: Up to 7500 lbs.

Wheel Diameters: 6", 8", 10", 12", 16", 18"
Brake: Not Applicable

Page
111



295 SERIES KINGPIN CASTERS

Tread Width: 3", 3-1/2", 4", 5"
Capacity: Up to 17000 lbs.

Wheel Diameters: 6", 8", 10", 12"
Brake: Not Applicable

Page
112



298 SERIES AVIATION GROUND EQUIPMENT CASTERS

Tread Width: 4-1/2", 6", 9"
Capacity: Up to 20000 lbs.

Wheel Diameters: 12", 16-1/4", 18"
Brake: Face Contact, Single/Double Sided, Swivel Lock

Pneumatic

Pages: 113-117

Page
114



16/72 SERIES CASTERS

Tread Width: 2", 2-1/2", 2-3/4", 3"
Capacity: Up to 540 lbs.

Wheel Diameters: 6", 10", 12"
Brake: Face Contact, Swivel Lock

Page
115



16/72/90 SERIES CASTERS

Tread Width: 2", 2.5", 2.8", 4.1", 4.8", 5.3", 5.7"
Capacity: Up to 1170 lbs.

Wheel Diameters: 8", 10", 12", 14", 16", 18"
Brake: Face Contact, Swivel Lock

Page
116



94/95 SERIES CASTERS

Tread Width: 4.8", 5.7", 6.5", 6.9", 7.5"
Capacity: Up to 3633 lbs.

Wheel Diameters: 16", 18", 21", 23", 25"
Brake: Face Contact, Swivel Lock

Page
117



272/290/294/295 SERIES CANTILEVER-STYLE CASTERS

Tread Width: 2.80", 4.10", 4.8", 5.3", 5.7", 6.5", 6.9", 7.5"
Capacity: Up to 7260 lbs.

Wheel Diameters: 8", 10", 12", 14", 16", 18", 21", 23", 25"
Brake: Face Contact, Swivel Lock

Aviation Industry/Ground Support Equipment (GSE)

Pages: 118-121

Page
119



03 SERIES AIR CARGO/CONVEYOR CASTERS

Tread Width: 1-11/32", 1-3/4"
Capacity: Up to 450 lbs.

Wheel Diameters: 2-1/4", 2-3/4"
Brake: Not Applicable

Page
120



FAULTLESS PRECISION, HEAVY DUTY AIR CARGO/CONVEYOR CASTERS

Tread Width: 1-3/8"
Capacity: Up to 375 lbs.

Wheel Diameters: 2-3/4"
Brake: Not Applicable

Page
121



JARVIS AIR CARGO/CONVEYOR CASTERS

Tread Width: 1-1/4"
Capacity: Up to 400 lbs.

Wheel Diameters: 3"
Brake: Not Applicable

Specialty

Pages: 122-129

Page
123



20/21 SERIES BUSINESS MACHINE CASTERS

Tread Width: 1.81"
Capacity: Up to 1200 lbs.

Wheel Diameters: 3"
Brake: Thumbscrew

Page
124



DC DOLLY CASTERS

Tread Width: 1-1/4"
Capacity: Up to 350 lbs.

Wheel Diameters: 3", 3-1/2", 4" and 5"
Brake: Total Lock, Face

Page
125



BASSICK HONCHO AS SERIES CASTERS

Tread Width: 2"
Capacity: Up to 1250 lbs.

Wheel Diameters: 4", 5", 6" and 8"
Brake: Total Lock, Side Lock, Swivel Lock

Page
126-
128



E-LINE ECONOMICAL CASTERS AND COMPONENTS

Tread Width: 2"
Capacity: Up to 1250 lbs.

Wheel Diameters: 4", 5", 6" and 8"
Brake: Total Lock, Face, Tread, Cam, Swivel Lock

Page
129



02/14 SERIES GATE CASTERS

Tread Width: 1", 2-1/2"
Capacity: Up to 210 lbs.

Wheel Diameters: 4", 8"
Brake: Not Applicable

Page
178-
191



CASTER ACCESSORIES

Caster Brakes: Pages 179-181
Swivel Locks/Pads/Jacks: Page 182

Floor Locks: Pages 183-185
Turntables/Bumpers/Replacement Parts: Pages 185-191





CONTENTS

WHEEL CONTENTS ON NEXT PAGES

>> Wheel Contents Follow on Next Page >>

Wheel Visual Table of Contents

Metal Tread >>>

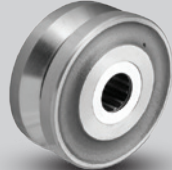
					
Cast Iron CA, CW, CH Pages 133-134	Flanged Cast Iron FL, FD Page 135	V-Groove Cast Iron VG, VL, VM Page 136	Ductile FM, FR Page 137	Drop Forged Steel FS, FH Page 138	Drop Forged Steel V-Groove VF, VH Page 139



Nylon Tread >>>

					
Maxim® NG Page 141	White Nylon NW Page 141	Trionix™ NX Page 142	Trionix™ V-Groove NV Page 142	High Heat Glass Filled HT Page 140	Heavy Duty Glass Filled DT Page 140



Phenolic Tread >>>

			
Phenolic Straight Sided TH, TS Page 143	Phenolic TM Page 143-144	Laminated Phenolic TL Page 144	Hi-Temp Phenolic TR Page 144



Polypropylene Tread >>>

	
Glass Filled RT Page 140	Polypropylene PB Page 145

Polypropylene Tread

	
Retort Hi-Temp Polypropylene RW Page 145	White Polypropylene PW Page 145

Polyurethane Tread >>>

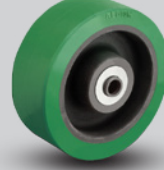
			
Vulkollan® on Cast Iron VY Page 149	Thick Tread Vulkollan® VX Page 150	Polyurethane on Iron Core* PY, PH Pages 151-152	Thick Tread Polyurethane* PX Page 153

*PY, PH and PX available in multiple durometers. 

Polyurethane Tread >>>

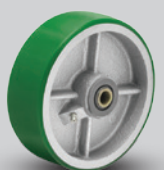
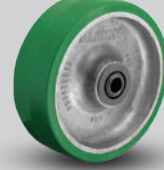
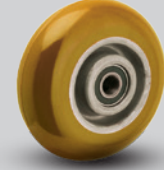

					
Polyurethane on Heavy Duty Cast Iron PF Page 154	Polyurethane on Cast Iron PI Page 154	Polyurethane Reactive PR Page 155	Polyurethane on Aluminum Core PA, PD Page 155	Round Tread Poly on Aluminum 95A PM Page 156	Round Tread Poly on Aluminum 80A PM 80A Page 156

Wheel Visual Table of Contents

Polyurethane Tread >>>

					
Polyurethane on Aluminum 85A AX Page 156	Magnum Round on Aluminum 95A UA Page 157	Magnum Round on Aluminum 80A UA 80A Page 157	Magnum Round on Aluminum 73D UA 73D Page 157	Magnum Round on Aluminum 70A UA 70A Page 157	Aubin Industries Swivel-EAZ® EY, EZ Page 158

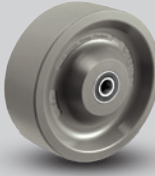
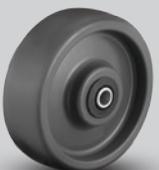
Polyurethane Tread >>>

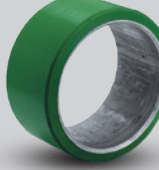
					
X-Treme Solid Polyurethane XI Page 160	X-Treme Plus Solid Polyurethane XP Page 160	Solid Elastomer SE Page 161	Polyurethane on Polypropylene XA Page 161	Premium Poly on Polypropylene EG Page 162	Polyurethane Press-On Tire OG Page 163-164

Polyurethane Tread

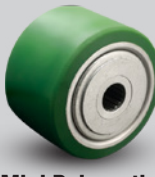
	
Mini Polyurethane Press-On Tire OG Page 165	Polyurethane V-Groove XV Page 165

Rubber Tread >>>

			
Full Pneumatic SF, SG Page 167	Hand Truck Wheel SO Page 168	Semi-Pneumatic SN Page 168	Monoprene Semi-Pneumatic SZ, SV Page 169

Rubber Tread >>>

					
Never Flat Tire NF Page 170	Ultimate Extra Soft Flat Tread XS, XY Page 171	Ultimate Extra Soft Round Tread XR Page 172	Heavy Duty Mold-On Rubber on Iron Core MH Page 173	Mold-On Rubber on Iron Core MR Pages 173-174	Mold-On Rubber on Die Cast Aluminum MD Page 175

Rubber Tread

			
Neoprene on Aluminum Flat Tread MG Page 176	Neoprene on Aluminum Round Tread NP Page 176	Rubber Press-On OA Page 177	Solid Rubber RR, RN Page 175

CASTER COMPONENTS

KINGPIN RIG

CONVENTIONAL CONSTRUCTION

• UP TO 2,000 LB. CAPACITY

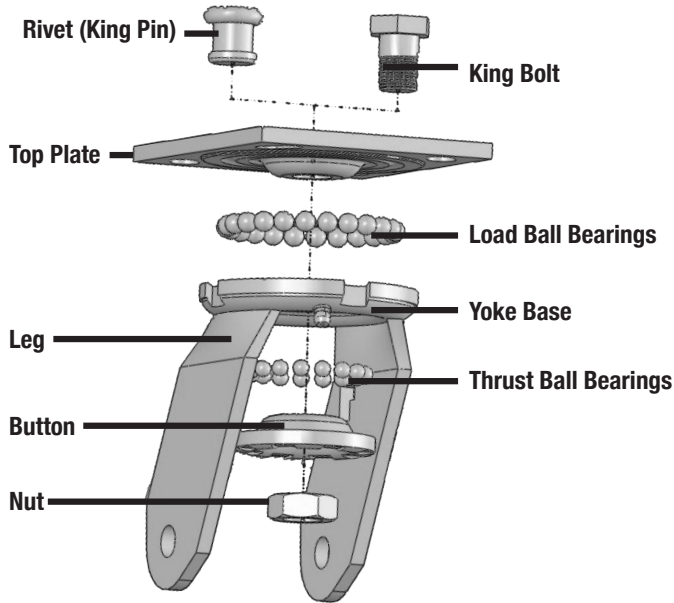

KINGPINLESS RIG



BETTER ERGONOMICS, BEST FOR SHOCK AND IMPACT

• UP TO 20,000 LBS. CAPACITY

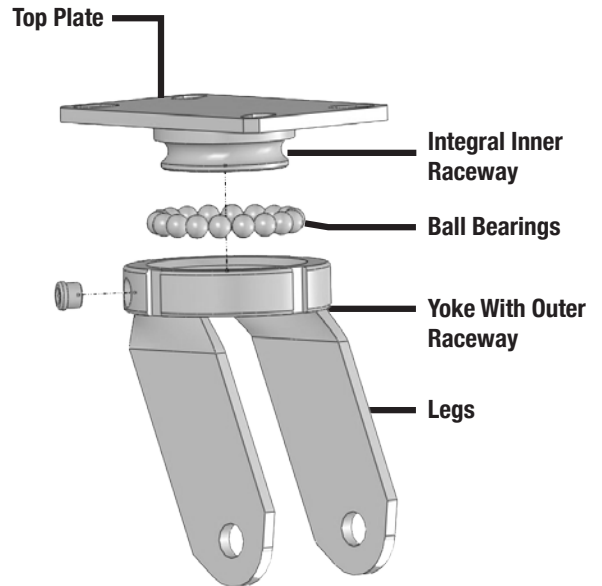

MAINTENANCE FREE SWIVEL SECTION



SEALED PRECISION SWIVEL BEARING PROVIDES EXCELLENT ERGONOMICS WITH NO MAINTENANCE

• UP TO 2,000 LBS. CAPACITY

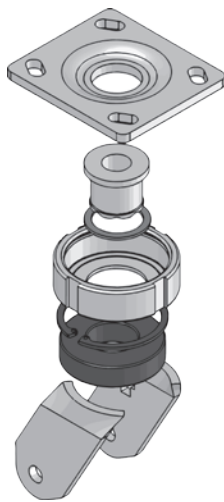

WHEEL

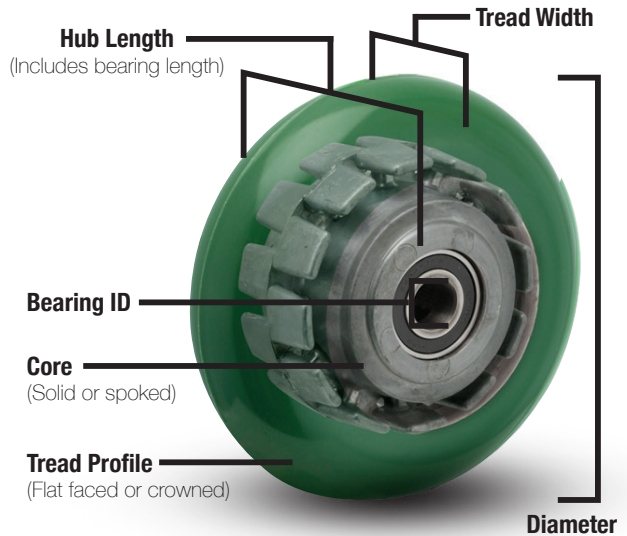

ALBION[®]
the caster experts

Need help determining the right solution for your application?

Let us help! Connect with us online at www.albioncasters.com or call us at 800-835-8911.

Rig SELECTION GUIDE

The right rig can make a big difference in the life and ergonomics of your caster.

Kingpin

MEDIUM HEAVY DUTY KINGPIN



Pages:
23-34

- » 140 – 2,000 lbs capacity
- » Conventional caster construction
- » Variety of raceway designs to support performance and load requirements

HEAVY DUTY KINGPIN



Pages:
59-74

- » 700 – 17,000 lbs capacity

Heavy Duty Kingpinless

LONGER LASTING THAN CONVENTIONAL CASTERS



Pages:
41-58

- » 300 – 20,000 lbs capacity
- » Best for rugged applications where impact, shock, or regular swiveling is present
- » Eliminates kingpin failures

Maintenance Free



Pages:
35-40

- » 350 – 2,000 lbs capacity
- » Designed for ergonomics and light to medium duty towing. Smooth, easy, and quiet mobility.

Stainless Steel



Pages:
75-86

- » 200 – 3,000 lbs capacity
- » Well suited for applications exposed to cleaning agents, steam, caustic solutions, or other corrosive agents which could cause rust

Spring Loaded



Pages:
87-99

- » 500 – 3,000 lbs capacity
- » Protects cargo and equipment from shocks and unwanted vibration

Dual Wheels



Pages:
100-112

- » 280 – 30,000 lbs capacity
- » Can help you increase your capacity and floor protection, while also providing easier turning

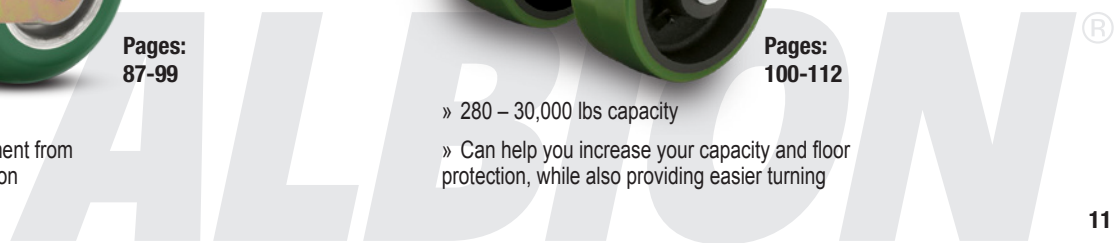

SELECTION GUIDE

Wheel Material

Selecting the right wheel can make a big difference in the performance and life of your caster. To determine what material would work best for your application, please review the below material descriptions and features — or connect with us at www.albioncasters.com or 800-835-8911 for specification assistance.

Polyurethane capacities up to 10,900 lbs



Description:

Albion's polyurethane wheels are uniquely formulated and open cast or injection molded to clean, close tolerance cores. Each unique formula is designed for specific mobility benefits, including: ergonomics, shock absorption, noise reduction, debris rejection, and overall durability.

Features:

- » Non-marking, floor protective
- » Resists chemicals and oils
- » Excellent capacity, wear resistance, and strength
- » Quieter and more shock absorbing than metal wheels
- » Designated wheels are towable
- » Various durometers, thicknesses, tread profiles and colors available

Rubber capacities up to 3,630 lbs



Description:

Rubber wheels provide exceptional floor protection, shock absorption, and our more advanced formulas even reject metal shavings and debris (X-tra Soft, MG, NP, SZ/SV). Various options can be found throughout our rubber wheel offering, including: non-marking formulas, no-maintenance/semi/fully pneumatic wheels, and a variety of durometers and color choices.

Features:

- » Floor protection
- » Quiet mobility
- » Cost effective
- » Shock absorption
- » Indoor/outdoor use (pneumatic family)

Metal capacities up to 20,000 lbs



Description:

Metal wheels offer the highest capacity, temperature resistance, and strength for your most abusive indoor/outdoor applications and floor conditions. Albion offers a range of materials to best suit your application, including: cast iron, ductile, and drop forged steel options.

Features:

- » Highest load capacities
- » Handles the most abuse
- » Impact resistant
- » Resistant to hot and cold temperatures

Phenolic capacities up to 8,000 lbs

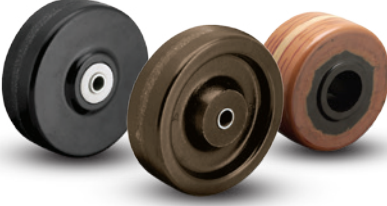

Description:

Phenolic wheels are constructed of heavy macerated materials impregnated with phenolic resins – and then molded under high heat and pressure to produce a quality, but economical industrial wheel.

Features:

- » High load capacities
- » Resistant to chemicals and oils
- » Impact resistant
- » Economical
- » High-temp options

Nylon & Glass Filled capacities up to 7,200 lbs



Description:

Offering high load capacities and greater floor protection than conventional metal or phenolic wheels, our range of Nylon and Glass-Filled wheels are a perfect fit for helping reduce wheel noise or in clean applications requiring frequent wash downs.

Features:

- » High load capacities
- » Impact resistant
- » Corrosion resistant
- » Resistant to chemicals and oils
- » High-temp options

Polypropylene capacities up to 1,000 lbs



Description:

Injection molded from a blend of thermoplastic polymers, Polypropylene wheels are our most economical and lightest wheel option with comparable load ratings to hard rubber wheels.

Features:

- » Most economical
- » Resistant to chemicals and oils
- » Lightweight
- » High-temp options

Wheel Bearing

SELECTION GUIDE

To understand how bearing codes are represented in part numbers, please visit [page 18](#).

Roller



Roller bearings are the standard bearing in most caster applications. 1-1/2 and 2 inch width wheels feature a cage separating hardened steel rollers and a hardened steel split outer race. These bearings must be used on a hardened bushing or shaft. Maximum temperature range is 350°F. All Casters and wheels are rated up to 2.5 mph operation per the Institute of Caster & Wheel Manufacturers Guidelines.

BEARING CODE:
01, 05, 07

Drawn Cup Roller



These are roller bearings as described above except they have metal cages holding the precision ground rollers. The outer race is a one-piece construction, giving added rigidity to the wheel bore. These bearings must be used on a hardened bushing or shaft. Maximum temperature range is 400°F.

BEARING CODE:
02

Precision Tapered Roller



The tapered roller is the most effective bearing for heavy or towed loads. The taper allows for some thrust loading, while the heat-treated inner and outer race allow for maximum load capacity. Maximum temperature range is 400°F.

BEARING CODE:
09

Bronze



Excellent for wash-down or steam cleaning applications. Bronze bearings are designed for temperatures up to 525°F.

BEARING CODE:
22

Oilex



These bearings are made of oil-impregnated sintered iron. Completely self-lubricating, these are ideal for situations where rolling force is less critical and accessibility for lubrication is difficult. Maximum temperature range is 450°F.

BEARING CODE:
23

Radial Ball (Industrial Ball)



Shielded ball bearings are often referred to as "industrial grade" bearings. Pressed into the hub of lower capacity wheels, these low cost bearings decrease the effort required to move a load. Maximum temperature range is 250°F.

BEARING CODE:
27

Precision Sealed Ball



Completely sealed, these precision ground ball bearings are held in a metal spacer ring between two hardened raceways. This bearing never needs to be lubricated, and with the lowest rolling resistance of all bearings it provides the most ergonomic situation available. Maximum temperature range is 250°F.

BEARING CODE:
28

Pedestal Precision Ball



These sealed precision ball bearings include an integral spanner which eliminates need for separate spanner. Maximum temperature range is 250°F.

BEARING CODE:
29

Annular Ball



A precision type bearing where the machined outer race and inner race are held together by the bearings. This option offers easy rolling and quiet operation for light to medium duty loads. This bearing must be factory installed in the wheel. Designed for temperatures up to 160°F.

BEARING CODE:
31

Plain Bore

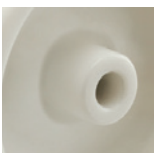

In this option, no bearing material is used. The wheel runs directly on the axle or spanner bushing. This is the least expensive bearing option, but also results in a higher rolling resistance.

BEARING CODE:
41

Two Piece Delrin



A DuPont™ engineered material, Delrin is designed for use in situations in which a self-lubricating material is optimal and corrosion cannot be tolerated. Ideal for wash-down or steam-cleaning applications as well as total immersion. Maximum temperature range is 160°F.

BEARING CODE:
51

One Piece Delrin



This is a one-piece version of the Delrin bearing listed above. Good for use where thrust washers are needed or to add rigidity to a soft wheel which might cause the two piece bearing to be ejected from the bore of the wheel. Maximum temperature range is 160°F.

BEARING CODE:
52

ERGONOMOMIC EXPERTS



The **right rig, wheel and bearing** can have a **BIG IMPACT** on your business and employees!

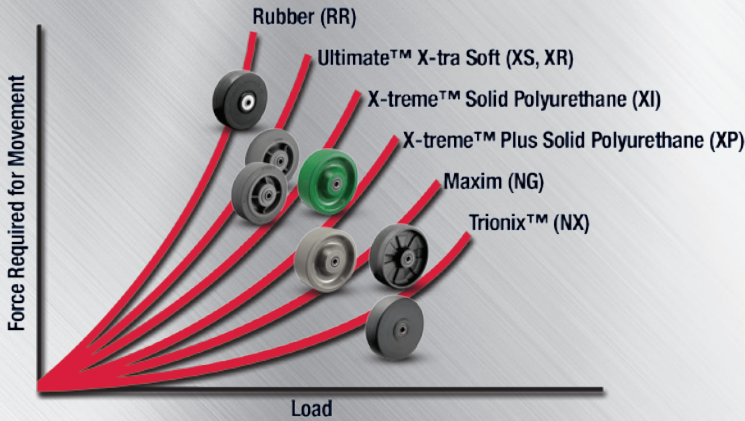

For more than 60 years Albion has been committed to easing the load of moving products through your facility. Long before ergonomics was popular, we were developing casters and wheels to reduce fatigue, reduce repetitive motion and improve productivity.

We have accelerated efforts to develop casters that ease the effort needed to start a cart in motion or swivel while in operation. Also, we explore the latest materials technologies to deliver wheels that offer the best performance and the best ergonomic qualities.

Leading the way in Albion's efforts toward ergonomic excellence are our maintenance free **18 Series** (pages 36-37) and **68 Series** (pages 38-39), along with a variety of other rig and wheel combinations throughout our **Heavy Duty Kingpinless** lineup (pages 41-58). Our maintenance free casters reduce the effort needed to bring a caster in line by **over 30%** in contrast to conventional dual ball raceway kingpin casters – plus they **reduced noise by 15%!**

WORKPLACE SAFETY & COST SAVINGS

- ▶ PUSH/PULL EASIER
- ▶ TURN EASIER
- ▶ REDUCE NOISE
- ▶ BOOST EFFICIENCY



LET US HELP

improve your employee satisfaction and bottom line through our ergonomic experience today! Connect with us **online at www.albioncasters.com** or **call 800-835-8911.**

POLYURETHANE EXPERTS

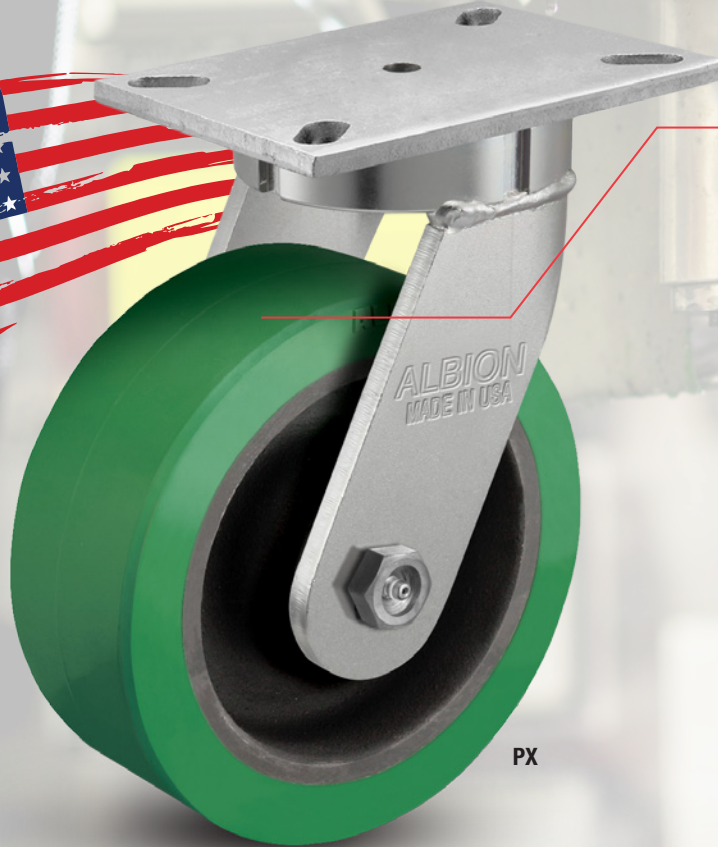

- Strong tread bond for long life
- Close tolerance cores for precise manufacturing and quality control
- Superior material blends for the highest quality treads



ALBION
the caster experts

- ▾ Albion offers an expansive range of polyurethane wheels, with various material blends designed to deliver specific features and application benefits (see pages 146-165 for full offering)
- ▾ Our popular **80A** and **95A** durometer wheels are **designed and proven for industrial use**—many offering a **3 year warranty**
- ▾ New formulas and tread profiles continue to be developed to **enhance ergonomics (AX, PF, and UA wheels)**
- ▾ Standard and custom keyway inserts are available
- ▾ Custom machining and crown facing
- ▾ Cutter bars, brakes, and sound dampening pads available
- ▾ Custom colors available (minimums may apply)
- ▾ **Specialty Wheel Development** – Albion’s team of engineers has significant experience designing and developing new wheels for specialty applications in virtually any industry. Contact factory with your needs!
- ▾ **Anti-Microbial Additives** – Bacterial inhibitors are available in many of our urethane products. If your food, medical, or laboratory application requires additional peace of mind, this is a great wheel solution.

PREVENZ™ ANTIMICROBIAL*

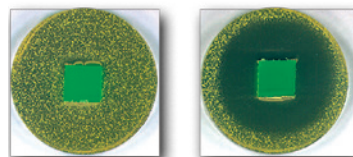

*Please contact factory for ordering information.

VULKOLLAN® WHEELS (VY/VX)

- **Highest quality** polyurethane in the world
- **Superior** in load capacity, reliability, strength, and life
- **Reduce** your downtime and maintenance costs with Vulkollan!

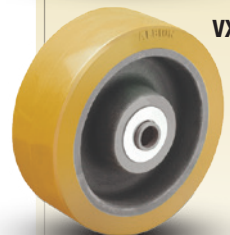

CUSTOM SOLUTIONS



IDENTIFY YOUR NEEDS.

- Capture Your Vision
- Identify All Requirements
- Evaluate Safety and Ergonomics

DESIGN IT.

- Leverage Proven Knowledge Base
- Create Solid 3D Model Design
- Finite Element Analysis (FEA)
- 3D Printing
- Rapid Prototyping



With more than 500,000 standard caster models available, it's likely that Albion has just the right caster for your application. However, if you have a unique application that requires a custom need, our experienced sales and engineering teams can partner with you to create a practical solution that meets your needs.

Whether it's a modification to an existing product or a brand new custom design, Albion has the engineering experience and technology to bring your concept to life.

ALBION®



TEST IT.

- ANSI ICWM Standards
- Durability & Impact
- Ergonomic Push/Pull
- Brake & Accessory Fatigue
- Customer Specified Testing



BUILD & DELIVER IT.

- U.S. Heavy Duty Manufacturing
- Global Supply Chain
- CNC: Laser, Bender, Machining
- Robotic & Skilled Manual Welding
- Experienced Finishing & Assembly

At Albion, every custom project is led by a single project manager. Our comprehensive process begins by capturing the customer vision and all application requirements, and ends with a customer approved product that has been tightly audited throughout the production process. Every stage is scrutinized and reviewed, providing a solid framework for all new product innovations. This process ensures that your mobility solution is brought to life on-time and on-budget.

ACCREDITATION AND AFFILIATES



With our proven design and manufacturing experience, we guarantee select Albion casters with up to a three (3) year warranty from date of purchase; look for the 3 year warranty icon throughout the catalog. All other Albion brand casters feature a (1) year warranty from date of purchase. Visit albioncasters.com/warranty for official warranty details.

Albion Product Numbering System

Below are helpful examples of Casters, Wheels, and Rig part numbers and what the respective numbering system and codes represents in each.

Casters

16PD06201S is a 16 Series 6" x 2" swivel top plate caster with Polyurethane/Aluminum core wheel and straight roller bearing. See below for caster number breakdown.

16	PD	06	2	01	S
Caster Series (16 Series)	Wheel Code (PD is Polyurethane on aluminum core) (see Wheel Section for codes, page 147 – 193)	Diameter Code (06 is 6")	Tread Width Code (2 is 2") 0: Less than 1-1/2 1: 1-1/2 to 1-5/8 2: 1-3/4 to 2 3: 2-1/8 to 2-7/16 4: 2-1/2 to 2-3/4 5: 2.8 to 3-3/8 6: 3-1/2 to 3-7/8 7: 4 to 4-7/8 8: 5 to 5-1/2 9: Over 5-1/2 X: 3-1/2 Dia. Wheel	Bearing Code (01 is Straight Roller Bearing) (see Bearing Section for codes, page 13)	Swivel/Rigid Code (S is swivel, R is rigid)

OPTIONAL FEATURES

To be listed under the caster model number when ordering.
Note: Some brake and swivel lock options are now placed at the end of the part number. Please see individual series for option designation.

CB	16
Option Code (CB is cam style brake)	Option Code (In this case cam style brake for 16 series caster)

Wheels

PD0620112 is a 6" x 2" Polyurethane/Aluminum core with 3/4" straight roller bearing.

PD	06	2	01	12
Wheel Code (PD is Polyurethane on aluminum core) (see Wheel Section for codes, page 147 – 193)	Diameter Code (06 is 6")	Tread Width Code (2 is 2") 0: Less than 1-1/2 1: 1-1/2 to 1-5/8 X: 1-1/4" tread width for 3-1/2" Dia. Wheels 2: 1-3/4 to 2 3: 2-1/8 to 2-7/16 4: 2-1/2 to 2-3/4 5: 2.8 to 3-3/8 6: 3-1/2 to 3-7/8 7: 4 to 4-7/8 8: 5 to 5-1/2 9: Over 5-1/2	Bearing Code (01 is Straight Roller Bearing) (see Bearing Section for codes, page 13) Note: for wheel less bearing order 41 or 00 depending on wheel. See wheel section pages 147-193)	Bearing ID Code (12 is 3/4") Bearing I.D. for wheels with bearing. Wheel bore I.D. for wheels less bearing. In 1/16" increments, for example: 12 divided by 16 or 3/4" Common Bore Sizes: 19 = 1-3/16 31 = 1-15/16 39 = 2-7/16

Rigs

16YA06201S is a Medium-heavy duty swivel rig that would accommodate the above 6" x 2" PD wheel.

16	YA	06	2	01	S
Caster Series (16 Series)	Rig Code (YA is rig only designation) YA: Standard YB: Moldon Lead YJ: Ball Load YN: Semi-Pneumatic YO: Full Pneumatic (Note: not all options included)	Diameter Code (06 is 6")	Inside Leg Spacing Code (2 means that rig fits 1-3/4" to 2" tread width wheel) See Tread Width Code in WHEELS above.	Axle/Nut Code (01 indicates Stripped rig, no parts) 00: Rig comes with axle, nut, spanner and thrust washers 03: Complete with axle and nut.	Swivel/Rigid Code (S is swivel, R is rigid)

>> **Product Pages**
Up Next >>

NOTE: We work hard to ensure all specifications and part numbers are accurately represented throughout our catalog, however catalog specifications are subject to change without notice. Please feel free to contact us to request a drawing, sample (minimums may apply) or to confirm any specification detail prior to ordering.

LIGHT DUTY CASTERS

CAPACITY RANGE 125-350 LBS



Common Applications:

- Dolly Carts
- Display Carts
- Food Service Carts
- Institutional Equipment
- Furniture Dollies
- Bakery Racks

02 Series

Designed for Light Duty Industrial or Institutional Applications



02 Series Institutional
Capacity to 350..... 20-21



P2 Series Precision
Light Duty
Capacity to 250..... 22

LIGHT DUTY

Premium Light Duty Casters That May Interest You ...

LIGHT DUTY PRECISION CASTERS



If you need the smoothest operation available for light duty products, choose **P2**. The sealed precision bearing in the swivel section offers quiet maintenance-free operation (see page 22).

LIGHT DUTY STAINLESS STEEL



If you need casters where frequent washdowns are necessary, or if your casters may be exposed to cleaning agents, steam, caustic solutions, or other corrosive agents which could cause rust or corrosion, choose **04 Series** (see page 77).

02

Institutional Casters

CAPACITY TO 350



Easy rolling, double ball bearing casters are ideally suited for virtually any operation where a smooth, highly maneuverable caster is required. Heat treated design delivers extended life and performance.

MOUNTING OPTIONS

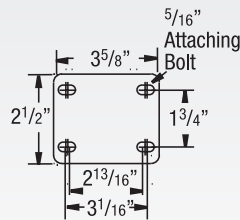

TYPICAL APPLICATIONS

- Hotel equipment
- Institutional equipment
- Food service racks and cases
- Stock carts
- Laundry trucks



Expandable Adapter
Kit numbers on next page. To order on caster consult factory.



Threaded Stem
1/2" diameter
13NC x 1", 1-1/2" or 2-1/2" long
(see next page)

Plate Models

+ For swivel models add "S", for rigid model add "R" to end of base caster number.

Wheel Diameter (Inches)	Tread Width (Inches)	Capacity (Lbs) (Roller for manual operation)	Overall Height (Inches)	Swivel Lead (Inches)	Approx. Wt. (Lbs)	Base Caster Number+
-------------------------	----------------------	---	-------------------------	----------------------	-------------------	---------------------

Soft Rubber (01 Straight Roller Bearing)*

RR	3	1 1/4	125	4 1/4	1 5/16	1.75	02RR03001
	3 1/2	1 1/4	150	4 11/16	1 1/4	1.75	02RR03X01
	4	1 1/4	150	5 1/8	1 1/4	2.25	02RR04001
	5	1 1/4	175	6 3/16	1 1/2	2.75	02RR05001

*Plain bore (41) available. Change "01" to "41"
(Example: 02RR03041).

Hard Rubber (41 Plain Bore)

RN	3	1 1/4	300	4 1/4	1 5/16	2.00	02RN03041
	3 1/2	1 1/4	350	4 11/16	1 1/4	2.00 <td>02RN03X41</td>	02RN03X41
	4	1 1/4	350	5 1/8	1 1/4	2.25 <td>02RN04041</td>	02RN04041
	5	1 1/4	350	6 3/16	1 1/2	2.75 <td>02RN05041</td>	02RN05041
	6	1 1/4	350	7 1/4	1 1/2	3.25 <td>02RN06041</td>	02RN06041

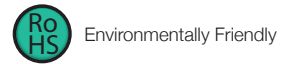

FEATURES

- **Top Plate & Yoke:** Heavily embossed, formed steel to extend caster life under rugged conditions
- **Swivel Section:** Heat treated double ball bearing raceways to resist wear and improve maneuverability
- **Kingpin:** 1/2" hydraulically formed steel rivet
- **Axle:** 3/8" diameter hollow axle with lock nut
- **Finish:** All rigs are zinc plated to resist rust and corrosion
- **NSF** Listed for food service industry, consult factory
- Alternate or custom caster configurations available

BEARING OPTIONS



RIG OPTIONS

- **Sealed wheel** (1/2" straight roller bearing with 1-1/16" bore) specify **SW02**
- **Sealed swivel** specify **SS01**
- Special **zerk fitting** for axle specify **ZF03**
- **"NSF"** listed for food industry, consult factory
- **Hollow kingpin** swivel rig available specify **YH** in place of wheel code (02YH03001S)
- **Stainless steel** versions available, see page 77

BRAKE OPTIONS

To order, add brake code below to end of model. Example: 02XS05031SGL

Grip Lock
specify **GL**



Face Contact
specify **F**



Total Lock
specify **T**



+ For swivel models add "S", for rigid model add "R" to end of base caster number.

Wheel Diameter (Inches)	Tread Width (Inches)	Capacity (Lbs) (Roller for manual operation)	Overall Height (Inches)	Swivel Lead (Inches)	Approx. Wt. (Lbs)	Base Caster Number+
-------------------------	----------------------	---	-------------------------	----------------------	-------------------	---------------------

X-tra Soft Rubber Flat Tread (31 Annular Ball)*

XS	3	1 1/4	200	4 1/4	1 5/16	1.75	02XS03031
	3 1/2	1 1/4	250	4 11/16	1 1/4	1.85 <td>02XS03X31</td>	02XS03X31
	4	1 1/4	300	5 1/8	1 1/4	2.00 <td>02XS04031</td>	02XS04031
	5	1 1/4	325	6 3/16	1 1/2	2.25 <td>02XS05031</td>	02XS05031
	6	1 1/4	350	7 1/4	1 1/2	2.40 <td>02XS06031</td>	02XS06031

*Delrin (51) bearing available. Change "31" to "51"
(Example: 02XS03051).

Precision X-tra Soft Round Tread (28 Precision Ball Bearing)

XR	3	1 1/4	200	4 1/4	1 5/16	1.75	02XR03028
	3 1/2	1 1/4	250	4 11/16	1 1/4	1.85 <td>02XR03X28</td>	02XR03X28
	4	1 1/4	300	5 1/8	1 1/4	2.00 <td>02XR04028</td>	02XR04028
	5	1 1/4	325	6 3/16	1 1/2	2.25 <td>02XR05028</td>	02XR05028

Polypropylene (41 Plain Bore)*

PB	3	1 1/4	250	4 1/4	1 5/16	1.75	02PB03041
	4	1 1/4	350	5 1/8	1 1/4	2.00 <td>02PB04041</td>	02PB04041
	5	1 1/4	350	6 3/16	1 1/2	2.25 <td>02PB05041</td>	02PB05041

*Delrin (51) bearing available. Change "41" to "51"
(Example: 02PB03051).

Polyurethane on Polypropylene (28 Precision Ball Bearing)*

XA	3	1 1/4	300	4 1/4	1 5/16	1.50	02XA03028
	3 1/2	1 1/4	350	4 11/16	1 1/4	1.50 <td>02XA03X28</td>	02XA03X28
	4	1 1/4	350	5 1/8	1 1/4	2.25 <td>02XA04028</td>	02XA04028
	5	1 1/4	350	6 3/16	1 1/2	2.75 <td>02XA05028</td>	02XA05028

*Annular (31) and Delrin (51) bearing available.
Change "28" to "31" or "51" (Example: 02XA030331).

Continue on next page >>

Plate Models

Continued from previous page

+ For swivel models add "S", for rigid model add "R" to end of base caster number.

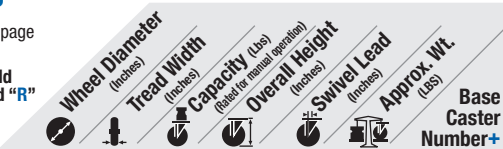

Phenolic (01 Straight Roller Bearing)*							
TM 	3	1 1/4	350	4 1/4	1 5/16	1.50	02TM03001
	3 1/2	1 1/4	350	4 1 1/16	1 1/4	2.00	02TM03X01
	4	1 1/4	350	5 1/8	1 1/4	2.00	02TM04001
	5	1 1/4	350	6 3/16	1 1/2	2.75	02TM05001
	*Plain bore (41) bearing available. Change "01" to other bearing code (Example 02TM03041).						

+ For swivel models add "S", for rigid model add "R" to end of base caster number.

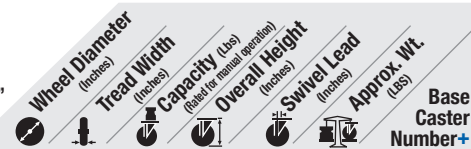

Cast Iron (01 Straight Roller Bearing)*							
CA 	3	1 1/4	200	4 1/4	1 5/16	2.50	02CA03001
	3 1/2	1 1/4	250	4 1 1/16	1 1/4	2.50	02CA03X01
	4	1 1/4	300	5 1/8	1 1/4	3.00	02CA04001
	5	1 1/4	325	6 3/16	1 1/2	3.50	02CA05001
	*Plain bore (41) available. Change "01" to other bearing code (Example 02CA03041).						

Threaded Stem Models Base caster numbers shown in chart. To order see stem codes below.

Soft Rubber (01 Straight Roller Bearing)*							
RR 	3	1 1/4	125	4 3/32	1 5/16	1.75	02RR03001
	3 1/2	1 1/4	150	4 17/32	1 1/4	1.75	02RR03X01
	4	1 1/4	150	4 31/32	1 1/4	2.25	02RR04001
	5	1 1/4	175	6 1/32	1 1/2	2.75	02RR05001
	*Delrin (51) bearing available. Change "01" to "51" to other bearing code (Example 02RR03051).						

Polypropylene (41 Plain Bore)*							
PB 	3	1 1/4	250	4 3/32	1 5/16	1.75	02PB03041
	4	1 1/4	350	4 31/32	1 1/4	2.00	02PB04041
	5	1 1/4	350	6 1/32	1 1/2	2.25	02PB05041
	*Delrin (51) bearing available. Change "41" to "51" (Example: 02PB03051).						

Hard Rubber (41 Plain Bore)							
RN 	3	1 1/4	300	4 3/32	1 5/16	2.00	02RN03041
	3 1/2	1 1/4	350	4 17/32	1 1/4	2.00	02RN03X41
	4	1 1/4	350	4 31/32	1 1/4	2.25	02RN04041
	5	1 1/4	350	6 1/32	1 1/2	2.75	02RN05041
	6	1 1/4	350	7 3/32	1 1/2	-	02RN06041
	*Delrin (51) bearing available. Change "41" to "51" to other bearing code (Example: 02RN03051).						

Polyurethane on Polypropylene (31 Annular Ball)*							
XA 	3	1 1/4	300	4 3/32	1 5/16	1.50	02XA03031
	3 1/2	1 1/4	350	4 17/32	1 1/4	1.50	02XA03X31
	4	1 1/4	350	4 31/32	1 1/4	2.25	02XA04031
	5	1 1/4	350	6 1/32	1 1/2	2.75	02XA05031
	*Delrin (51) bearing available. Change "31" to "51" (Example: 02XA03051).						

X-tra Soft Rubber Flat Tread (31 Annular Ball)*							
XS 	3	1 1/4	200	4 3/32	1 5/16	1.75	02XS03031
	3 1/2	1 1/4	250	4 17/32	1 1/4	1.85	02XS03X31
	4	1 1/4	300	4 31/32	1 1/4	2.00	02XS04031
	5	1 1/4	325	6 1/32	1 1/2	2.25	02XS05031
	6	1 1/4	350	7 3/32	1 1/2	-	02XS06031
*Delrin (51) bearing available. Change "31" to "51" (Example: 02XS03051).							

Prevenz™ antimicrobial models available. Add PREV to end of caster number.

Phenolic (01 Straight Roller Bearing)*							
TM 	3	1 1/4	350	4 3/32	1 5/16	1.50	02TM03001
	3 1/2	1 1/4	350	4 17/32	1 1/4	2.00	02TM03X01
	4	1 1/4	350	4 31/32	1 1/4	2.00	02TM04001
	5	1 1/4	350	6 1/32	1 1/2	2.75	02TM05001
	*Plain bore (41) available. Change "01" to other bearing code (Example: 02TM03041).						

Precision X-tra Soft Round Tread (28 Precision Ball Bearing)*							
XR 	3	1 1/4	200	4 3/32	1 5/16	1.75	02XR03028
	3 1/2	1 1/4	250	4 17/32	1 1/4	1.85	02XR03X28
	4	1 1/4	300	4 31/32	1 1/4	2.00	02XR04028
	5	1 1/4	325	6 1/32	1 1/2	2.25	02XR05028
	*Delrin (51) bearing available. Change "28" to "51" to other bearing code (Example: 02XR03051).						

Cast Iron (01 Straight Roller Bearing)*							
CA 	3	1 1/4	200	4 3/32	1 5/16	2.50	02CA03001
	3 1/2	1 1/4	250	4 17/32	1 1/4	2.50	02CA03X01
	4	1 1/4	300	4 31/32	1 1/4	3.00	02CA04001
	5	1 1/4	325	6 1/32	1 1/2	3.50	02CA05001
	*Plain bore (41) available. Change "01" to other bearing code (Example: 02CA03041).						

Threaded Stem Order Codes (To order, add to base number above. Example: 02RR03001 S32) Note: Threads are 1/2" Diameter 13 NC			
Wheel Diameter (Inches)	Type 1: 1" Long Option Code	Type 2: 1-1/2" Long Option Code	Type 3: 2-1/2" Long For Expandable Adapters Option Code
3	S32	S31	S33
3 1/2	SX2	SX1	SX3
4	S42	S41	S43
5	S52	S51	S53

Hollow Kingpin Swivel Rig	
	Hollow kingpin swivel rig available specify YH in place of wheel code (02YH03001S). Hole accommodates 1/2" fittings. To order complete caster assembly, consult factory.

Expandable Adapter Kits (Fits any 13 NC threaded stem caster over 2-1/2" long)	
Stem Description For	Kit Number
Round and Square Tubing	
3/4" to 7/8" (19.1mm to 22.2mm)	SX123200
7/8" to 1" (22.2mm to 25.4mm)	SX143200
1" to 1-1/8" (25.4mm to 28.6mm)	SX163200
1-1/8" to 1-1/4" (28.6mm to 31.8mm)	SX183200
1-1/4" to 1-1/2" (31.8mm to 38.1mm)	SX203200
1-1/2" to 1-3/4" (38.1mm to 44.5mm)	SX243200
1-3/4" to 2" (44.5mm to 50.8mm)	SX283200
Kits come in individual plastic bags and include nut, black rubber expander and white nylon spacer. Kits fit any 1/2" 13 NC threaded stem caster over 2-1/2" long.	
To order pre-installed adapters consult factory.	

02 SERIES • CAPACITY TO 350

LIGHT DUTY

P2 Precision Light Duty Casters

CAPACITY TO 250



The smoothest operation available for light duty products. The sealed precision bearing in the swivel section offers quiet, maintenance-free operation.

TYPICAL APPLICATIONS

- Hotel Equipment
- Institutional Equipment
- Food Service
- Racks and Cases
- Stock Carts
- Laundry Trucks

MOUNTING PLATE

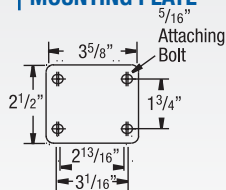

MAINTENANCE FREE SWIVEL CROSS SECTION

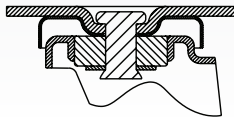

Ergonomic



Maintenance Free



Premium Quality



Environmentally Friendly

FEATURES

- **Top Plate & Yoke:** Heavily embossed, formed steel to extend caster life under rugged conditions
- **Swivel Section:** Sealed precision bearing in swivel section
- **Axle:** 3/8" diameter hollow axle with lock nut
- **Finish:** All rigs are zinc plated to resist rust and corrosion
- Alternate or custom caster configurations available

BRAKE OPTIONS

To order, add brake code below to end of model. Example: P2XS05031F

Face Contact specify **F**



Total Lock specify **T**

- Ergonomic Caster
- Smooth, Quiet Operation
- Maintenance Free

+ For swivel models add "S", for rigid model add "R" to end of base caster number.

Wheel Diameter (Inches)	Tread Width (Inches)	Capacity (Lbs) (Subject to normal operation)	Overall Height (Inches)	Swivel Lead (Inches)	Approx. Wt. (Lbs)	Base Caster Number+
-------------------------	----------------------	---	-------------------------	----------------------	-------------------	---------------------

X-tra Soft Rubber Round Tread (28 Precision Ball Bearing)

XR	Wheel Diameter (Inches)	Tread Width (Inches)	Capacity (Lbs)	Overall Height (Inches)	Swivel Lead (Inches)	Approx. Wt. (Lbs)	Base Caster Number
	3	1 1/4	200	4 1/4	1 5/16	1.75	P2XR03028
	3 1/2	1 1/4	250	4 11/16	1 1/4	1.85	P2XR03X28
	4	1 1/4	250	5 1/8	1 1/4	2.25	P2XR04028
	5	1 1/4	250	6 3/16	1 1/2	2.75	P2XR05028

X-tra Soft Rubber Flat Tread (31 Annular Ball Bearing)

XS	Wheel Diameter (Inches)	Tread Width (Inches)	Capacity (Lbs)	Overall Height (Inches)	Swivel Lead (Inches)	Approx. Wt. (Lbs)	Base Caster Number
	3	1 1/4	200	4 1/4	1 5/16	1.75	P2XS03031
	3 1/2	1 1/4	250	4 11/16	1 1/4	1.85	P2XS03X31
	4	1 1/4	250	5 1/8	1 1/4	2.25	P2XS04031
	5	1 1/4	250	6 3/16	1 1/2	2.75	P2XS05031

Prevenz™ antimicrobial models available. Add PREV to end of caster model.

Polyurethane on Polypropylene (31 Annular Ball Bearing)

XA	Wheel Diameter (Inches)	Tread Width (Inches)	Capacity (Lbs)	Overall Height (Inches)	Swivel Lead (Inches)	Approx. Wt. (Lbs)	Base Caster Number
	3	1 1/4	250	4 1/4	1 5/16	1.50	P2XA03031
	3 1/2	1 1/4	250	4 11/16	1 1/4	1.50	P2XA03X31
	4	1 1/4	250	5 1/8	1 1/4	2.25	P2XA04031
	5	1 1/4	250	6 3/16	1 1/2	2.25	P2XA05031

Prevenz™ antimicrobial models available. Add PREV to end of caster model.

Prevenz™ Antimicrobial Wheels

The EPA registered and FDA compliant antimicrobial additive used in Prevenz™ wheels is designed to suppress the growth of a variety of destructive and odor causing microbes including bacteria, molds, mildew and fungi. These wheels are suitable for a variety of applications including medical equipment, food equipment, pharmaceutical, chemical, meat & poultry, processing plants and more. To order add "PREV" to end of caster number.



XA Prevenz™
Polyurethane on
Polypropylene

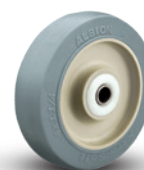

XS Prevenz™
X-tra-soft Rubber
Flat Tread

MEDIUM HEAVY DUTY CASTERS

CAPACITY RANGE 210-2000 LBS



16 Series
Medium Duty Casters

Common Applications:

- Dollies
- Waste Disposal Trucks
- Shop Carts
- Floor Trucks
- Warehouse Trucks
- Distribution Cages and Carts



16 Series Medium Heavy Duty
Capacity to 125024-26



71 Series Heavy Duty
Capacity to 150031-32



62 Series Heavy Duty
Capacity to 150027-29



72 Series Heavy Duty
Capacity to 160033-34



63 Series Heavy Duty
Capacity to 2000 30

MEDIUM HEAVY DUTY CASTERS

Premium and Specialty Medium Heavy Duty Casters That May Interest You ...

ERGONOMIC CASTERS



If you need the smoothest operation available in medium heavy duty casters see the Maintenance-Free Section (pages 35-40).

LONGER LASTING KINGPINLESS



If you need casters that will be impacted or shock-loaded ... or casters more suited for power-towed applications see the Heavy Duty Kingpinless Section (pages 41-58).

STAINLESS STEEL CASTERS



If you need casters where frequent washdowns are necessary, or if your casters may be exposed to cleaning agents, steam, caustic solutions, or other corrosive agents which could cause rust or corrosion see the Stainless Steel Section (pages 75-86).

SPRING LOADED CASTERS



If you need casters that offer spring loaded protection from damaging shock, unwanted vibration and reduced noise levels, see the Spring Loaded Section (pages 87-89).

16 Series Medium Heavy Duty Casters

Made in the **USA**

CAPACITY TO 1250



Premium Quality



Environmentally Friendly



MOUNTING OPTIONS Standard Plate

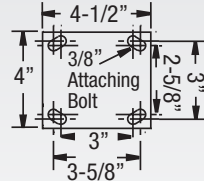

Special Order Plates

Optional D Plate

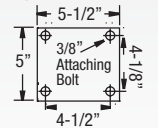

Optional K Plate

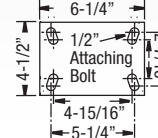

TYPICAL APPLICATIONS

- Shop/Distribution Carts
- Dollies
- Waste disposal trucks
- Warehouse trucks
- Floor Trucks

SWIVEL CROSS SECTION



+ For swivel models add "S", for rigid model add "R" to end of base caster number.

Wheel Diameter (Inches)	Tread Width (Inches)	Capacity (Lbs) (Rated for manual operation)	Overall Height (Inches)	Swivel Lead (Inches)	Approx. Wt. (Lbs)	Base Caster Number+
-------------------------	----------------------	---	-------------------------	----------------------	-------------------	---------------------

Neoprene on Aluminum (28 Precision Ball Bearing)

NP	Wheel Diameter (Inches)	Tread Width (Inches)	Capacity (Lbs)	Overall Height (Inches)	Swivel Lead (Inches)	Approx. Wt. (Lbs)	Base Caster Number+
	5	2	600	6 1/2	1 5/8		16NP05228
	6	2	700	7 1/4	1 3/4		16NP06228
	8	2	700	9 1/2	1 3/4		16NP08228

Moldon Rubber on Cast Iron (01 Roller Bearing)

MR	Wheel Diameter (Inches)	Tread Width (Inches)	Capacity (Lbs)	Overall Height (Inches)	Swivel Lead (Inches)	Approx. Wt. (Lbs)	Base Caster Number+
	4	1 1/2	250	5 5/8	1 11/16	5 3/4	16MR04101
	4	2	300	5 5/8	1 11/16	5 1/4	16MR04201
	5	1 1/2	350	6 1/2	1 5/8	6	16MR05101
	5	2	450	6 1/2	1 5/8	5 1/2	16MR05201
	6	2	500	7 1/4	1 3/4	8	16MR06201
	8	2	600	9 1/2	1 3/4	10 1/4	16MR08201

Heavy Duty Moldon Rubber on Cast Iron (01 Roller Bearing)

MH	Wheel Diameter (Inches)	Tread Width (Inches)	Capacity (Lbs)	Overall Height (Inches)	Swivel Lead (Inches)	Approx. Wt. (Lbs)	Base Caster Number+
	3 1/4	1 1/2	340	4 1/4	1 3/4	4 1/2	16MH03101
	4	1 1/2	400	5 5/8	1 11/16	5 3/4	16MH04101
	5	2	700	6 1/2	1 5/8	5 1/2	16MH05201
	6	2	820	7 1/4	1 3/4	8	16MH06201
	8	2	1000	9 1/2	1 3/4	10 1/4	16MH08201

FEATURES

- All caster rigs and many wheels **now made in the USA**
- **3 Year** warranty
- **New upper/Lower Raceway Rubber seals:** Optional rubber swivel raceway seals help protect casters
- **Improved zinc plated finish** for attractive appearance, better corrosion resistance and longer caster life
- **Bigger kingpin:** New bigger, stronger 3/4" kingpin on standard top plate
- **Top Plate & Yoke Base:** Cold formed from 1/4" steel plate. Yoke base is notched for factory or field-installable 4-position swivel lock
- **Swivel Section:** Smooth formed, hardened double ball bearing raceways minimize ball indentation and wear
- **Fork Legs:** 1/4" steel, formed to increase strength and welded to yoke base
- **Axle:** 1/2" diameter hollow axle complete with lock nut with straight roller and Delrin bearings. Axle is solid with ball, plain bore, and Oilex bearings
- **Wheel seals:** Nylon seal retaining/thrust washers
- **Lubrication:** Zerk fitting in swivel section and in recessed head of hollow axle on straight roller and Delrin bearing wheels
- Alternate or custom caster configurations available

RIG OPTIONS

- King bolt and nut specify **KB16**
- Neoprene sealed swivel section specify **SS02**
- NSF Listed for food service industry specify **NSF**
- Notched seal kit specify **SD016001**
- Unnotched seal kit specify **SD016002**
- **Optional Overall Heights** see notes at end of 16 Series section
- **Stainless steel** versions available, see page 78-79

BRAKE OPTIONS

To order, add brake code below to end of model. Example: 16XS06201ST

Total Lock specify **T** (4" to 8" models) specify optional 7 1/2" (HS-60) overall height model if ordering 6"

Grip Lock specify **GL1**

Cam specify **CB1**

Face specify **FBA**

Face specify **FBB**

Single Side specify **SSB**. **Double Sided** specify **DSB**

Face specify **FBE**

Poly Cam specify **P**

Swivel Lock (welded) specify **L**

Hand operated field installable swivel lock order **SL160000** separately

Foot operated field installable swivel lock order **SL160002** separately

BEARING OPTIONS



Note: Wheel capacities can change with each bearing type. Consult factory.

+ For swivel models add "S", for rigid model add "R" to end of base caster number.

Moldon Rubber on Aluminum (01 Roller Bearing)

MD	Wheel Diameter (Inches)	Tread Width (Inches)	Capacity (Lbs)	Overall Height (Inches)	Swivel Lead (Inches)	Approx. Wt. (Lbs)	Base Caster Number+
	4	1 1/2	250	5 5/8	1 11/16	4 3/4	16MD04101
	5	1 1/2	300	6 1/2	1 5/8	5	16MD05101
	6	2	550	7 1/4	1 3/4	6	16MD06201
	8	2	600	9 1/2	1 3/4	6 1/2	16MD08201

Continue on next page >>

+ For swivel models add "S", for rigid model add "R" to end of base caster number.

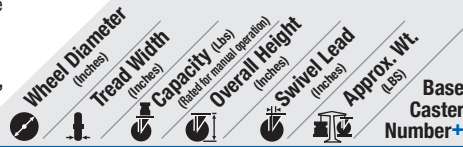

Soft Rubber (01 Roller Bearing)

RR	Wheel Diameter (Inches)	Tread Width (Inches)	Capacity (Lbs)	Overall Height (Inches)	Swivel Lead (Inches)	Approx. Wt. (Lbs)	Base Caster Number+
	4	2	220	5 5/8	1 11/16	6	16RR04201
	5	2	325	6 1/2	1 5/8	6 1/2	16RR05201
	6	2	350	7 1/4	1 3/4	6 3/4	16RR06201

Monoprene Semi-Pneumatic (27 Radial Ball Bearing)

SZ	Wheel Diameter (Inches)	Tread Width (Inches)	Capacity (Lbs)	Overall Height (Inches)	Swivel Lead (Inches)	Approx. Wt. (Lbs)	Base Caster Number+
	6	2	250	7 1/4	1 3/4	5 1/2	16SZ06227
	8	2	280	9 1/2	1 3/4	6 1/2	16SZ08227

For grey tread specify "SV" wheel code (example 16SV05228).

Pneumatic (27 Radial Ball Bearing)

SF	Wheel Diameter (Inches)	Tread Width (Inches)	Capacity (Lbs)	Overall Height (Inches)	Swivel Lead (Inches)	Approx. Wt. (Lbs)	Base Caster Number+
	8	2	210	9 1/2	1 3/4	6 1/2	16SF08227

Eagle Polyurethane on Polypropylene (01 Roller Bearing)

EG	Wheel Diameter (Inches)	Tread Width (Inches)	Capacity (Lbs)	Overall Height (Inches)	Swivel Lead (Inches)	Approx. Wt. (Lbs)	Base Caster Number+
	4	2	600	5 5/8	1 11/16	5 3/4	16EG04201
	5	2	900	6 1/2	1 5/8	5 1/2	16EG05201
	6	2	1100	7 1/4	1 3/4	8	16EG06201
	8	2	1200	9 1/2	1 3/4	10 1/4	16EG08201

X-tra Soft (Flat Tread) (01 Roller Bearing)*

XS	Wheel Diameter (Inches)	Tread Width (Inches)	Capacity (Lbs)	Overall Height (Inches)	Swivel Lead (Inches)	Approx. Wt. (Lbs)	Base Caster Number+
	4	2	350	5 5/8	1 11/16	5 1/4	16XS04201
	5	2	375	6 1/2	1 5/8	5 1/2	16XS05201
	6	2	600	7 1/4	1 3/4	6	16XS06201
	8	2	675	9 1/2	1 3/4	6 1/2	16XS08201

Prevenz™ antimicrobial models available (Add PREV).
*Precision Ball (28) and Delrin (51) Bearings available.
Change "01" to other bearing code. Precision Ball example: 16XS04228. Delrin example: 16XS04251.

X-tra Soft (Round Tread) (01 Roller Bearing)*

XR	Wheel Diameter (Inches)	Tread Width (Inches)	Capacity (Lbs)	Overall Height (Inches)	Swivel Lead (Inches)	Approx. Wt. (Lbs)	Base Caster Number+
	6	2	450	7 1/4	1 3/4	5 1/2	16XR06201
	8	2	600	9 1/2	1 3/4	6 1/2	16XR08201

Prevenz™ antimicrobial models available (Add PREV).
*Precision Ball (28) and Delrin (51) Bearings available.
Change "01" to other bearing code. Precision Ball example: 16XR04228. Delrin example: 16XR04251.

Polypropylene (01 Roller Bearing)*

PB	Wheel Diameter (Inches)	Tread Width (Inches)	Capacity (Lbs)	Overall Height (Inches)	Swivel Lead (Inches)	Approx. Wt. (Lbs)	Base Caster Number+
	4	1 1/2	400	5 5/8	1 11/16	4 1/2	16PB04101
	4	2	450	5 5/8	1 11/16	4 1/2	16PB04201
	5	1 1/2	450	6 1/2	1 5/8	5	16PB05101
	5	2	550	6 1/2	1 5/8	5	16PB05201
	6	1 1/2	550	7 1/4	1 3/4	5 3/4	16PB06101
	6	2	750	7 1/4	1 3/4	6	16PB06201
	8	2	850	9 1/2	1 3/4	5 1/2	16PB08201

*Delrin (51) Bearings or plain bore (41) models available.
Change "01" to other bearing code. Delrin example: 16PB04251.

White Polypropylene (41 Plain Bore)

PW	Wheel Diameter (Inches)	Tread Width (Inches)	Capacity (Lbs)	Overall Height (Inches)	Swivel Lead (Inches)	Approx. Wt. (Lbs)	Base Caster Number+
	4	2	450	5 5/8	1 11/16	4 1/2	16PW04241
	5	2	550	6 1/2	1 5/8	5	16PW05241
	6	2	650	7 1/4	1 3/4	6	16PW06241

High Temp Polypropylene (41 Plain Bore)

RW	Wheel Diameter (Inches)	Tread Width (Inches)	Capacity (Lbs)	Overall Height (Inches)	Swivel Lead (Inches)	Approx. Wt. (Lbs)	Base Caster Number+
	4	2	500	5 5/8	1 11/16	5	16RW04241
	5	2	650	6 1/2	1 5/8	5 1/2	16RW05241
	6	2	700	7 1/4	1 3/4	6	16RW06241
	8	2	900	9 1/2	1 3/4	6 1/2	16RW08241

+ For swivel models add "S", for rigid model add "R" to end of base caster number.

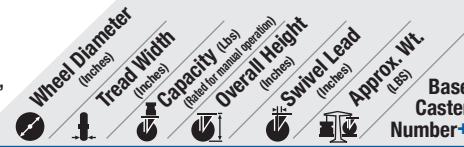

Polyurethane on Aluminum (01 Roller Bearing)

PD	Wheel Diameter (Inches)	Tread Width (Inches)	Capacity (Lbs)	Overall Height (Inches)	Swivel Lead (Inches)	Approx. Wt. (Lbs)	Base Caster Number+
	4	1 1/2	600	5 5/8	1 11/16	4 1/2	16PD04101
	4	2	700	5 5/8	1 11/16	5	16PD04201
	5	1 1/2	720	6 1/2	1 5/8	5	16PD05101
	5	2	1050	6 1/2	1 5/8	5 1/4	16PD05201
	6	2	1230	7 1/4	1 3/4	5 3/4	16PD06201
	8	2	1250	9 1/2	1 3/4	7	16PD08201

Polyurethane on Aluminum Round Tread (28 Precision Ball Bearing)

AX	Wheel Diameter (Inches)	Tread Width (Inches)	Capacity (Lbs)	Overall Height (Inches)	Swivel Lead (Inches)	Approx. Wt. (Lbs)	Base Caster Number+
	4	2	700	5 5/8	1 11/16	5 1/2	16AX04228
	5	2	1000	6 1/2	1 5/8	6	16AX05228
	6	2	1250	7 1/4	1 3/4	7	16AX06228
	8	2	1250	9 1/2	1 3/4	9	16AX08228

85 Shore A

Polyurethane on Aluminum Round Tread (28 Precision Ball Bearing)

PM	Wheel Diameter (Inches)	Tread Width (Inches)	Capacity (Lbs)	Overall Height (Inches)	Swivel Lead (Inches)	Approx. Wt. (Lbs)	Base Caster Number+
	5	2	1000	6 1/2	1 5/8	6	16PM05228
	6	2	1250	7 1/4	1 3/4	7	16PM06228
	8	2	1250	9 1/2	1 3/4	9	16PM08228

95 Shore A

Polyurethane on Aluminum Round Tread (28 Precision Ball Bearing)

PM 80A	Wheel Diameter (Inches)	Tread Width (Inches)	Capacity (Lbs)	Overall Height (Inches)	Swivel Lead (Inches)	Approx. Wt. (Lbs)	Base Caster Number+
	5	2	1000	6 1/2	1 5/8	6	16PM0522880A
	6	2	1250	7 1/4	1 3/4	7	16PM0622880A
	8	2	1250	9 1/2	1 3/4	9	16PM0822880A

80 Shore A To Specify Rigid or Swivel, insert "R" or "S" before "80A". Example: 16PY08228R80A.

Polyurethane on Cast Iron (01 Roller Bearing)

PY	Wheel Diameter (Inches)	Tread Width (Inches)	Capacity (Lbs)	Overall Height (Inches)	Swivel Lead (Inches)	Approx. Wt. (Lbs)	Base Caster Number+
	3 1/4	1 5/8	420	4 1/4	1 3/4	4 1/4	16PY03101
	4	2	750	5 5/8	1 11/16	7	16PY04201
	5	2	1050	6 1/2	1 5/8	8	16PY05201
	6	2	1200	7 1/4	1 3/4	9 3/4	16PY06201
	8	2	1250	9 1/2	1 3/4	10	16PY08201

80A Durometer available, add "80A" to end of caster number.
80A capacity reduced by approximately 20%.
Swivel example: 16PY06201S80A.

Polyurethane on Polypropylene (01 Roller Bearing)

XA	Wheel Diameter (Inches)	Tread Width (Inches)	Capacity (Lbs)	Overall Height (Inches)	Swivel Lead (Inches)	Approx. Wt. (Lbs)	Base Caster Number+
	4	2	600	5 5/8	1 11/16	4 1/4	16XA04201
	5	2	750	6 1/2	1 5/8	4 3/4	16XA05201
	6	2	900	7 1/4	1 3/4	5 1/2	16XA06201
	8	2	1000	9 1/2	1 3/4	7 1/2	16XA08201

Prevenz™ antimicrobial models available.
Add PREV to end of caster number.

V-Grooved Solid Polyurethane (02 Drawn Cup Roller Bearing)*

XV	Wheel Diameter (Inches)	Tread Width (Inches)	Capacity (Lbs)	Overall Height (Inches)	Swivel Lead (Inches)	Approx. Wt. (Lbs)	Base Caster Number+
	4	2	300	5 5/8	1 11/16	4 1/2	16XV04202
	5	2	300	6 1/2	1 5/8	5	16XV05202
	6	2	300	7 1/4	1 3/4	5 1/4	16XV06202
	8	2	300	9 1/2	1 3/4	5 3/4	16XV08202

*Delrin (52) Bearings models available.
Change "02" to other bearing code. Example: 16XV04252.

X-Treme™ Solid Polyurethane (01 Roller Bearing)*

XI	Wheel Diameter (Inches)	Tread Width (Inches)	Capacity (Lbs)	Overall Height (Inches)	Swivel Lead (Inches)	Approx. Wt. (Lbs)	Base Caster Number+
	4	2	1000	5 5/8	1 11/16	5	16XI04201
	5	2	1000	6 1/2	1 5/8	5 1/2	16XI05201
	6	2	1000	7 1/4	1 3/4	6 1/4	16XI06201
	8	2	1000	9 1/2	1 3/4	8	16XI08201

*Drawn Cup Roller (02), Bronze (22), Pedestal Precision (28), and Delrin (51) bearings available. Change "01" to other bearing code. Pedestal Precision example: 16XI04229.

Continue on next page >>

+ For swivel models add "S", for rigid model add "R" to end of base caster number.



X-Treme™ Plus Solid Polyurethane (01 Roller Bearing)*

XP	Wheel Diameter (inches)	Tread Width (inches)	Capacity (lbs)	Overall Height (inches)	Swivel Lead (inches)	Approx. Wt. (lbs)	Base Caster Number+
4	2	1250	5 ⁵ / ₈	1 ¹¹ / ₁₆	5	16XP04201	
5	2	1200	6 ¹ / ₂	1 ⁵ / ₈	5 ¹ / ₂	16XP05201	
6	2	1250	7 ¹ / ₄	1 ³ / ₄	6 ¹ / ₄	16XP06201	
8	2	1250	9 ¹ / ₂	1 ³ / ₄	8	16XP08201	

*Drawn Cup Roller (02), Bronze (22), Pedestal Precision (29), and Delrin (51) bearings available. Change "01" to other bearing code. Pedestal Precision example: 16XP04229.

Phenolic (01 Roller Bearing)

TM	Wheel Diameter (inches)	Tread Width (inches)	Capacity (lbs)	Overall Height (inches)	Swivel Lead (inches)	Approx. Wt. (lbs)	Base Caster Number+
3 ¹ / ₄	1 ¹ / ₂	600	4 ¹ / ₄	1 ³ / ₄	4 ¹ / ₂	16TM03101	
3 ¹ / ₄	2	700	4 ¹ / ₄	1 ³ / ₄	4 ¹ / ₂	16TM03201	
4	1 ¹ / ₂	600	5 ⁵ / ₈	1 ¹¹ / ₁₆	4 ¹ / ₂	16TM04101	
4	2	800	5 ⁵ / ₈	1 ¹¹ / ₁₆	5	16TM04201	
5	1 ¹ / ₂	600	6 ¹ / ₂	1 ⁵ / ₈	5 ¹ / ₄	16TM05101	
5	2	1000	6 ¹ / ₂	1 ⁵ / ₈	5 ¹ / ₄	16TM05201	
6	1 ¹ / ₂	800	7 ¹ / ₄	1 ³ / ₄	5 ¹ / ₂	16TM06101	
6	2	1200	7 ¹ / ₄	1 ³ / ₄	6 ¹ / ₄	16TM06201	
8	2	1250	9 ¹ / ₂	1 ³ / ₄	8	16TM08201	

Straight Sided Phenolic (01 Roller Bearing)

TH	Wheel Diameter (inches)	Tread Width (inches)	Capacity (lbs)	Overall Height (inches)	Swivel Lead (inches)	Approx. Wt. (lbs)	Base Caster Number+
4	2	1000	5 ⁵ / ₈	1 ¹¹ / ₁₆	5	16TH04201	
5	2	1200	6 ¹ / ₂	1 ⁵ / ₈	5 ¹ / ₂	16TH05201	
6	2	1250	7 ¹ / ₄	1 ³ / ₄	6 ¹ / ₄	16TH06201	

Maxim® (01 Roller Bearing)*

NG	Wheel Diameter (inches)	Tread Width (inches)	Capacity (lbs)	Overall Height (inches)	Swivel Lead (inches)	Approx. Wt. (lbs)	Base Caster Number+
3 ¹ / ₄	2	700	4 ¹ / ₄	1 ³ / ₄	5	16NG03201	
4	2	800	5 ⁵ / ₈	1 ¹¹ / ₁₆	5	16NG04201	
5	2	1000	6 ¹ / ₂	1 ⁵ / ₈	5 ¹ / ₂	16NG05201	
6	2	1200	7 ¹ / ₄	1 ³ / ₄	6 ¹ / ₄	16NG06201	
8	2	1250	9 ¹ / ₂	1 ³ / ₄	8	16NG08201	

Prevenz™ antimicrobial models available. Add PREV to end of caster number. *Drawn Cup Roller (02), Bronze (22), Pedestal Precision (29), and Delrin (51) bearings available. Change "01" to other bearing code. Pedestal Precision example: 16NG04229.

Glass Filled Polypropylene (01 Roller Bearing)

RT	Wheel Diameter (inches)	Tread Width (inches)	Capacity (lbs)	Overall Height (inches)	Swivel Lead (inches)	Approx. Wt. (lbs)	Base Caster Number+
4	2	800	5 ⁵ / ₈	1 ¹¹ / ₁₆		16RT04201	
5	2	1000	6 ¹ / ₂	1 ⁵ / ₈		16RT05201	
6	2	1200	7 ¹ / ₄	1 ³ / ₄		16RT06201	
8	2	1250	9 ¹ / ₂	1 ³ / ₄		16RT08201	

Heavy Duty Glass Filled Nylon (01 Roller Bearing)

DT	Wheel Diameter (inches)	Tread Width (inches)	Capacity (lbs)	Overall Height (inches)	Swivel Lead (inches)	Approx. Wt. (lbs)	Base Caster Number+
4	2	800	5 ⁵ / ₈	1 ¹¹ / ₁₆		16DT04201	
5	2	1200	6 ¹ / ₂	1 ⁵ / ₈		16DT05201	
6	2	1250	7 ¹ / ₄	1 ³ / ₄		16DT06201	
8	2	1250	9 ¹ / ₂	1 ³ / ₄		16DT08201	

High Temp Glass Filled Nylon (01 Roller Bearing)

HT	Wheel Diameter (inches)	Tread Width (inches)	Capacity (lbs)	Overall Height (inches)	Swivel Lead (inches)	Approx. Wt. (lbs)	Base Caster Number+
4	2	800	5 ⁵ / ₈	1 ¹¹ / ₁₆		16HT04201	
5	2	1000	6 ¹ / ₂	1 ⁵ / ₈		16HT05201	
6	2	1200	7 ¹ / ₄	1 ³ / ₄		16HT06201	
8	2	1250	9 ¹ / ₂	1 ³ / ₄		16HT08201	

Trionix™ High Impact Polymer (28 Precision Ball Bearing)

NX	Wheel Diameter (inches)	Tread Width (inches)	Capacity (lbs)	Overall Height (inches)	Swivel Lead (inches)	Approx. Wt. (lbs)	Base Caster Number+
4	2	1250	5 ⁵ / ₈	1 ¹¹ / ₁₆	7	16NX04228	
5	2	1250	6 ¹ / ₂	1 ⁵ / ₈	8	16NX05228	
6	2	1250	7 ¹ / ₄	1 ³ / ₄	9 ³ / ₄	16NX06228	
8	2	1250	9 ¹ / ₂	1 ³ / ₄	10	16NX08228	

+ For swivel models add "S", for rigid model add "R" to end of base caster number.



Solid Elastomer (28 Precision Ball Bearing)

SE	Wheel Diameter (inches)	Tread Width (inches)	Capacity (lbs)	Overall Height (inches)	Swivel Lead (inches)	Approx. Wt. (lbs)	Base Caster Number+
4	2	1000	5 ⁵ / ₈	1 ¹¹ / ₁₆	7	16SE04228	
5	2	1000	6 ¹ / ₂	1 ⁵ / ₈	8	16SE05228	
6	2	1100	7 ¹ / ₄	1 ³ / ₄	9 ³ / ₄	16SE06228	
8	2	1200	9 ¹ / ₂	1 ³ / ₄	10	16SE08228	

White Nylon (01 Roller Bearing)

NW	Wheel Diameter (inches)	Tread Width (inches)	Capacity (lbs)	Overall Height (inches)	Swivel Lead (inches)	Approx. Wt. (lbs)	Base Caster Number+
5	2	600	6 ¹ / ₂	1 ⁵ / ₈	6	16NW05201	
6	2	900	7 ¹ / ₄	1 ³ / ₄	7	16NW06201	
8	2	1100	9 ¹ / ₂	1 ³ / ₄	8 ¹ / ₂	16NW08201	

Cast Iron (01 Roller Bearing)

CA	Wheel Diameter (inches)	Tread Width (inches)	Capacity (lbs)	Overall Height (inches)	Swivel Lead (inches)	Approx. Wt. (lbs)	Base Caster Number+
3 ¹ / ₄	1 ¹ / ₂	400	4 ¹ / ₄	1 ³ / ₄	4 ¹ / ₂	16CA03101	
3 ¹ / ₄	2	700	4 ¹ / ₄	1 ³ / ₄	6 ³ / ₄	16CA03201	
4	1 ¹ / ₂	600	5 ⁵ / ₈	1 ¹¹ / ₁₆	6	16CA04101	
4	1 ⁷ / ₈	1000	5 ⁵ / ₈	1 ¹¹ / ₁₆	7	16CA04201	
5	1 ¹ / ₂	600	6 ¹ / ₂	1 ⁵ / ₈	6 ³ / ₄	16CA05101	
5	1 ⁷ / ₈	1250	6 ¹ / ₂	1 ⁵ / ₈	8	16CA05201	
6	1 ¹ / ₂	800	7 ¹ / ₄	1 ³ / ₄	7 ³ / ₄	16CA06101	
6	1 ⁷ / ₈	1250	7 ¹ / ₄	1 ³ / ₄	9 ³ / ₄	16CA06201	
8	2	1250	9 ¹ / ₂	1 ³ / ₄	12 ¹ / ₂	16CA08201	

Heavy Duty Cast Iron (01 Roller Bearing)

CH	Wheel Diameter (inches)	Tread Width (inches)	Capacity (lbs)	Overall Height (inches)	Swivel Lead (inches)	Approx. Wt. (lbs)	Base Caster Number+
5	2	1250	6 ¹ / ₂	1 ⁵ / ₈	9	16CH05201	
6	2	1250	7 ¹ / ₄	1 ³ / ₄	11	16CH06201	
8	2	1250	9 ¹ / ₂	1 ³ / ₄	14	16CH08201	

Dropped Forged Steel (01 Roller Bearing)*

FS	Wheel Diameter (inches)	Tread Width (inches)	Capacity (lbs)	Overall Height (inches)	Swivel Lead (inches)	Approx. Wt. (lbs)	Base Caster Number+
4	1 ¹ / ₂	1250	5 ⁵ / ₈	1 ¹¹ / ₁₆	7	16FS04101	
5	1 ³ / ₄	1250	6 ¹ / ₂	1 ⁵ / ₈	8 ³ / ₄	16FS05201	
6	2	1250	7 ¹ / ₄	1 ³ / ₄	9 ³ / ₄	16FS06201	

*Tapered Roller bearings (09) available. Change "01" to other bearing code. (Example: 16FS04109).

V-Grooved Cast Iron (01 Roller Bearing)*

VG	Wheel Diameter (inches)	Tread Width (inches)	Capacity (lbs)	Overall Height (inches)	Swivel Lead (inches)	Approx. Wt. (lbs)	Base Caster Number+
4	2	800	5 ⁵ / ₈	1 ¹¹ / ₁₆	7	16VG04201	
5	2	800	6 ¹ / ₂	1 ⁵ / ₈	8 ³ / ₄	16VG05201	
6	2	1000	7 ¹ / ₄	1 ³ / ₄	9 ³ / ₄	16VG06201	

*Tapered Roller bearings (09) available. Change "01" to other bearing code. (Example: 16VG04109).

Ductile Iron Crowned Tread (01 Roller Bearing)

FR, FM	Wheel Diameter (inches)	Tread Width (inches)	Capacity (lbs)	Overall Height (inches)	Swivel Lead (inches)	Approx. Wt. (lbs)	Base Caster Number+
5	2	1250	6 ¹ / ₂	1 ⁵ / ₈	9	16FR05201	
6	2	1250	7 ¹ / ₄	1 ³ / ₄	11	16FR06201	
8	2	1250	9 ¹ / ₂	1 ³ / ₄	14	16FR08201	

*Tapered Roller bearings (09) and Precision Ball (28) available. Tapered Roller example: 16FR05209. Note: Ductile Iron Flat Tread (FM) models available. Change FR wheel code to FM. Example: 12FM05201.

Optional Overall Heights all 16 Series Models:

Wheel Dia.	Overall Height	Swivel Lead	Swivel Specify	Rigid Specify	Wheel Dia.	Overall Height	Swivel Lead	Swivel Specify	Rigid Specify
3-1/4"	5-1/4"	1-11/16"	HS42	HR42	6"	6-7/8"	2-1/2"	HS56	HR56
4"	5-1/4"	1-11/16"	HS86	HR86	6"	7-3/8"	1-3/4"	HS59	HR59
5"	6-1/8"	1-11/16"	HS50	HR50	6"	7-1/2"	1-7/8"	HS60	HR60
5"	6-3/4"	1-3/4"	HS54	HR54	8"	10"	1-3/4"	HS81	HR81

62

Medium Heavy Duty Casters CAPACITY TO 1500



Premium Quality



Environmentally Friendly



Manufactured from cold formed steel, this popular series features a heat treated king bolt and nut, ensuring durability and a longer caster life.

MOUNTING OPTIONS Standard Plate

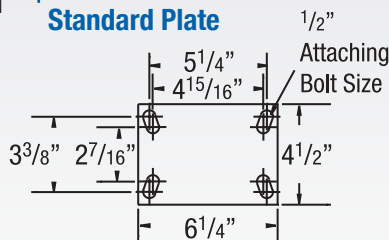

Special Order Plate D Plate (61 Series Plate)

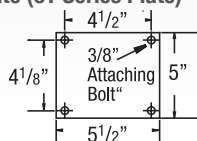

TYPICAL APPLICATIONS

- Movable racks
- Conveyor or "Dragline" operations
- Utility trucks
- Corrugated box trucks
- Caster mounted production jigs and fixtures

SWIVEL CROSS SECTION

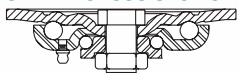

FEATURES

- **Top Plate:** Cold formed from 1/4" steel plate to provide the strongest possible section for swivel bearing
- **Swivel Section:** 3-1/4" diameter load race. Raceways are coined smooth then heat treated to minimize ball indentation and wear
- **Legs:** 1/4" steel formed to increase strength and welded to the yoke base
- **King bolt:** 3/4" heat treated king bolt and nut assembly
- **Axle:** 1/2" diameter hollow axle with recessed zerk fitting and lock nut on straight roller and Delrin bearing. Solid axle on ball and Oilex bearings
- **Lubrication:** Zerk fitting in swivel section and in recessed head of hollow axle with straight roller bearing wheels
- **Finish:** All rigs are zinc plated to resist corrosion and rust
- **Notched Yoke Base:** Notched to accommodate swivel lock
- Alternate or custom caster configurations available

BEARING OPTIONS



RIG OPTIONS

- Neoprene **sealed swivel** section specify **NS62**
- **Inside weld** specify **IW62**
- **Thread guards** specify **TG62**
- **Hollow axle** for oilex applications specify **ZF07** (For up to 2" wide wheels)
- **NSF Listed** for food service industry specify **NSF**
- **Optional Overall Heights** see notes at end of 62 Series section

BRAKE OPTIONS

To order, add brake code below to end of model. Example: 62XS06201SCB62

Cam specify **CB62**



Face specify **FBB** (Not available on 10" models)

Single Side specify **SSB62**. Double Sided specify **DSB62**



Poly Cam specify **P**

Swivel Lock (welded) specify **L**



Hand operated field installable swivel lock for standard plate order **SL620000** separately; for D plate order **SL610000** separately

+ For swivel models add "S", for rigid model add "R" to end of base caster number.

Wheel Diameter (Inches)	Tread Width (Inches)	Capacity (Lbs) (Based on manual operation)	Overall Height (Inches)	Swivel Lead (Inches)	Approx. Wt. (Lbs)	Base Caster Number+
-------------------------	----------------------	--	-------------------------	----------------------	-------------------	---------------------

Moldon Rubber on Cast Iron (01/07 Straight Roller)*

MR	Wheel Diameter	Tread Width	Capacity	Overall Height	Swivel Lead	Approx. Wt.	Base Caster Number
	4	2	300	5 5/8"	1 5/16"	6 1/2"	62MR04201
	5	2	450	6 1/2"	1 1/2"	7 1/2"	62MR05201
	6	2	500	7 1/2"	1 3/4"	9 1/2"	62MR06201
	6	2	700	7 1/2"	1 3/4"	12"	62MR06407
	8	2	600	10 1/8"	1 3/4"	9 1/4"	62MR08201
	8	2 1/2	850	10 1/8"	1 3/4"	14 1/2"	62MR08407
	10	2 1/2	950	11 1/2"	1 3/4"	18 1/4"	62MR10407

*Oilex (23), Industrial Ball (27), and one piece Delrin (52) available. Change "01" or "07" to bearing code. Oilex example: 62MR04223.

Heavy Duty Moldon Rubber on Cast Iron (01/07 Straight Roller)*

MH	Wheel Diameter	Tread Width	Capacity	Overall Height	Swivel Lead	Approx. Wt.	Base Caster Number
	5	2	700	6 1/2"	1 1/2"	7 1/2"	62MH05201
	6	2	820	7 1/2"	1 3/4"	9 1/2"	62MH06201
	8	2	1000	10 1/8"	1 3/4"	9 1/4"	62MH08201
	8	2 1/2	1300	10 1/8"	1 3/4"	14 1/2"	62MH08407
	10	2 1/2	1500	11 1/2"	1 3/4"	18 1/4"	62MH10407

*Oilex (23), Industrial Ball (27), and one piece Delrin (52) available. Change "01" or "07" to other bearing code. Oilex example: 62MH04223.

+ For swivel models add "S", for rigid model add "R" to end of base caster number.

Wheel Diameter (Inches)	Tread Width (Inches)	Capacity (Lbs) (Based on manual operation)	Overall Height (Inches)	Swivel Lead (Inches)	Approx. Wt. (Lbs)	Base Caster Number+
-------------------------	----------------------	--	-------------------------	----------------------	-------------------	---------------------

Moldon Rubber on Aluminum (01 Roller Bearing)

MD	Wheel Diameter	Tread Width	Capacity	Overall Height	Swivel Lead	Approx. Wt.	Base Caster Number
	4	2	400	5 5/8"	1 5/16"	6 1/2"	62MD04201
	5	2	500	6 1/2"	1 1/2"	7 1/2"	62MD05201
	6	2	550	7 1/2"	1 3/4"	9 1/2"	62MD06201
	8	2	600	10 1/8"	1 3/4"	9 1/4"	62MD08201

X-tra Soft Flat Tread (01 Roller Bearing)*

XS	Wheel Diameter	Tread Width	Capacity	Overall Height	Swivel Lead	Approx. Wt.	Base Caster Number
	4	2	400	5 5/8"	1 5/16"	6 1/2"	62XS04201
	5	2	500	6 1/2"	1 1/2"	7 1/2"	62XS05201
	6	2	600	7 1/2"	1 3/4"	8 1/4"	62XS06201
	8	2	675	10 1/8"	1 3/4"	9 1/4"	62XS08201

Prevenz™ antimicrobial models available. Add PREV to end of caster number.

*Precision Ball (28) and Delrin (51) Bearings available. Change "01" to other bearing code. Delrin example: 62XS04251.

62 SERIES • CAPACITY TO 1500

MEDIUM HEAVY DUTY CASTERS

Continue on next page >>

62 Series Continued

+ For swivel models add "S", for rigid model add "R" to end of base caster number.

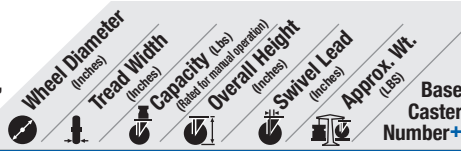

X-tra Soft Round Tread (01 Roller Bearing)*

XR	6	2	450	7 1/2	1 3/4	8 1/4	62XR06201
	8	2	600	10 1/8	1 3/4	9 1/4	62XR08201

Prevenz™ antimicrobial models available. Add PREV to end of caster number.

*Precision Ball (28) and Delrin (51) Bearings available. Change "01" to bearing code. Delrin example: 62XR04251.

Pneumatic (27 Industrial Ball Bearing)

SF	8	2	210	10 1/8	1 3/4	7 1/4	62SF08227
----	---	---	-----	--------	-------	-------	-----------

Polyurethane on Aluminum Crown Tread (01 Roller Bearing)

PD	4	2	700	5 5/8	1 5/16	6 1/2	62PD04201
	5	2	1050	6 1/2	1 1/2	6 1/2	62PD05201
	6	2	1230	7 1/2	1 3/4	7 1/4	62PD06201
	8	2	1500	10 1/8	1 3/4	8 1/2	62PD08201

Polyurethane on Aluminum Round Tread (28 Precision Ball Bearing)

AX	5	2	1000	6 1/2	1 1/2	7 1/4	62AX05228
	6	2	1250	7 1/2	1 3/4	8 1/4	62AX06228
	8	2	1500	10 1/8	1 3/4	10 1/2	62AX08228
	85 Shore A						

Polyurethane on Aluminum Round Tread (28 Precision Ball Bearing)

PM	5	2	1000	6 1/2	1 1/2	7 1/4	62PM05228
	6	2	1250	7 1/2	1 3/4	8 1/4	62PM06228
	8	2	1500	10 1/8	1 3/4	10 1/2	62PM08228
	95 Shore A						

Polyurethane on Aluminum Round Tread (28 Precision Ball Bearing)

PM 80A	5	2	1000	6 1/2	1 1/2	7 1/4	62PM0522880A
	6	2	1250	7 1/2	1 3/4	8 1/4	62PM0622880A
	8	2	1500	10 1/8	1 3/4	10 1/2	62PM0822880A
	80 Shore A						

To Specify Rigid or Swivel, insert "R" or "S" before "80A". Example: 62PM08228R80A.

Polyurethane on Cast Iron (01, 07 Roller Bearing)

PY	4	2	750	5 5/8	1 5/16	10	62PY04201
	5	2	1050	6 1/2	1 3/4	12	62PY05201
	6	2	1200	7 1/2	1 3/4	12	62PY06201
	6	2 1/2	1500	7 1/2	1 3/4	13	62PY06407
	8	2	1500	10 1/8	1 3/4	14	62PY08201
	8	2 1/2	1500	10 1/8	1 3/4	16	62PY08407
	10	2 1/2	1500	11 1/2	1 3/4	17	62PY10407

Polyurethane on Cast Iron (28 Precision Ball Bearing)

PY 80A	4	2	600	5 5/8	1 5/16	10	62PY0422880A
	5	2	840	6 1/2	1 3/4	13	62PY0522880A
	6	2	960	7 1/2	1 3/4	13	62PY0622880A
	6	2 1/2	1300	7 1/2	1 3/4	13	62PY0642880A
	8	2	1200	10 1/8	1 3/4	16	62PY0822880A
	8	2 1/2	1500	10 1/8	1 3/4	16	62PY0842880A
	10	2 1/2	1500	11 1/2	1 3/4	17	62PY1042880A

To Specify Rigid or Swivel, insert "R" or "S" before "80A". Example: 62PY08228R80A.

+ For swivel models add "S", for rigid model add "R" to end of base caster number.

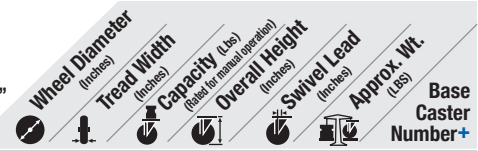

Polyurethane on Polypropylene (01 Roller Bearing)

XA	4	2	600	5 5/8	1 5/16		62XA04201
	5	2	750	6 1/2	1 1/2	7 1/2	62XA05201
	6	2	900	7 1/2	1 3/4	8 1/4	62XA06201
	8	2	1000	10 1/8	1 3/4	9 1/2	62XA08201

Prevenz™ antimicrobial models available. Add PREV to end of caster number.

X-Treme™ Solid Polyurethane (01 Roller Bearing)*

XI	4	2	1000	5 5/8	1 5/16	6 1/4	62XI04201
	5	2	1000	6 1/2	1 1/2	5 1/2	62XI05201
	6	2	1000	7 1/2	1 3/4	7 3/4	62XI06201
	8	2	1000	10 1/8	1 3/4	9 1/2	62XI08201

*Drawn Cup Roller (02), Bronze (22), Precision Ball (28) Pedestal Precision (29), and Delrin (51) bearings available. Change "01" to other bearing code. Pedestal Precision example: 62XI04229.

X-Treme™ Plus Solid Polyurethane (01 Roller Bearing)*

XP	4	2	1400	5 5/8	1 5/16	6 1/4	62XP04201
	5	2	1200	6 1/2	1 1/2	6 3/4	62XP05201
	6	2	1400	7 1/2	1 3/4	7 3/4	62XP06201
	8	2	1200	10 1/8	1 3/4	9 1/2	62XP08201

*Drawn Cup Roller (02), Bronze (22), Precision Ball (28) Pedestal Precision (29), and Delrin (51) bearings available. Change "01" to other bearing code. Pedestal Precision example: 62XP04229.

Phenolic (01, 07 Roller Bearing)

TM	4	2	800	5 5/8	1 5/16	6 1/4	62TM04201
	5	2	1000	6 1/2	1 1/2	6 3/4	62TM05201
	6	2	1200	7 1/2	1 3/4	7 3/4	62TM06201
	6	2 1/2	1500	7 1/2	1 3/4	9	62TM06407
	8	2	1400	10 1/8	1 3/4	9 1/2	62TM08201
	8	2 1/2	1500	10 1/8	1 3/4	11 1/4	62TM08407
	10	2 1/2	1500	11 1/2	1 3/4	13	62TM10407

Maxim® (01 Roller Bearing)*

NG	4	2	800	5 5/8	1 5/16	6 1/4	62NG04201
	5	2	1000	6 1/2	1 1/2	6 3/4	62NG05201
	6	2	1200	7 1/2	1 3/4	7 3/4	62NG06201
	8	2	1400	10 1/8	1 3/4	9 1/4	62NG08201

Prevenz™ antimicrobial models available. Add PREV to end of caster number.

*Drawn Cup Roller (02), Bronze (22), Pedestal Precision (29), and Delrin (51) bearings available. Change "01" to other bearing code. Pedestal Precision example: 62NG04229.

Continue on next page >>

+ For swivel models add "S", for rigid model add "R" to end of base caster number.



Trionix™ High Impact Polymer (28 Precision Ball Bearing)

NX	Wheel Diameter (inches)	Tread Width (inches)	Capacity (lbs) (Rated for manual operation)	Overall Height (inches)	Swivel Lead (inches)	Approx. Wt. (Lbs)	Base Caster Number+
	4	2	1500	5 ⁵ / ₈	1 ⁵ / ₁₆	8 ¹ / ₄	62NX04228
	5	2	1500	6 ¹ / ₂	1 ¹ / ₂	8 ³ / ₄	62NX05228
	6	2	1500	7 ¹ / ₂	1 ³ / ₄	11	62NX06228
	8	2	1500	10 ¹ / ₈	1 ³ / ₄	14	62NX08228

For 2-1/2" tread width models change 7th number from 2 to 4 (Example: 62NX0428).

Cast Iron (01, 07 Roller Bearing)

CA	Wheel Diameter (inches)	Tread Width (inches)	Capacity (lbs) (Rated for manual operation)	Overall Height (inches)	Swivel Lead (inches)	Approx. Wt. (Lbs)	Base Caster Number+
	4	2	1000	5 ⁵ / ₈	1 ⁵ / ₁₆	8 ¹ / ₄	62CA04201
	5	2	1300	6 ¹ / ₂	1 ¹ / ₂	9 ¹ / ₄	62CA05201
	6	2	1400	7 ¹ / ₂	1 ³ / ₄	11 ¹ / ₄	62CA06201
	6	2 1/2	1500	7 ¹ / ₂	1 ³ / ₄	13	62CA06407
	8	2	1500	10 ¹ / ₈	1 ³ / ₄	14 ¹ / ₂	62CA08201
	8	2 1/2	1500	10 ¹ / ₈	1 ³ / ₄	16	62CA08407

Heavy Duty Cast Iron (01 Roller Bearing)

CH	Wheel Diameter (inches)	Tread Width (inches)	Capacity (lbs) (Rated for manual operation)	Overall Height (inches)	Swivel Lead (inches)	Approx. Wt. (Lbs)	Base Caster Number+
	5	2	1500	6 ¹ / ₂	1 ¹ / ₂	10 ¹ / ₄	62CH05201
	6	2	1500	7 ¹ / ₂	1 ³ / ₄	11	62CH06201
	8	2	1500	10 ¹ / ₈	1 ³ / ₄	14 ¹ / ₂	62CH08201

White Nylon (01 Roller Bearing)*

NW	Wheel Diameter (inches)	Tread Width (inches)	Capacity (lbs) (Rated for manual operation)	Overall Height (inches)	Swivel Lead (inches)	Approx. Wt. (Lbs)	Base Caster Number+
	5	2	600	6 ¹ / ₂	1 ¹ / ₂	6 ³ / ₄	62NW05201
	6	2	900	7 ¹ / ₂	1 ³ / ₄	7 ³ / ₄	62NW06201
	8	2	1100	10 ¹ / ₈	1 ³ / ₄	9 ¹ / ₄	62NW08201

*Delrin (51) Bearings or plain bore (00) models available. Change "01" to other bearing code (Example: 62NW05251).

+ For swivel models add "S", for rigid model add "R" to end of base caster number.



Drop Forged Steel (01 Roller Bearing)*

FS	Wheel Diameter (inches)	Tread Width (inches)	Capacity (lbs) (Rated for manual operation)	Overall Height (inches)	Swivel Lead (inches)	Approx. Wt. (Lbs)	Base Caster Number+
	4	1 1/2	1400	5 ⁵ / ₈	1 ⁵ / ₁₆	8 ¹ / ₄	62FS04101
	5	1 3/4	1500	6 ¹ / ₂	1 ¹ / ₂	10 ¹ / ₄	62FS05201
	6	2	1500	7 ¹ / ₂	1 ³ / ₄	11 ¹ / ₄	62FS06201

*Tapered Roller bearings (09) available. Change "01" to other bearing code. Example: 62FS04109.

Ductile Iron Crowned Tread (01 Roller Bearing)*

FR, FM	Wheel Diameter (inches)	Tread Width (inches)	Capacity (lbs) (Rated for manual operation)	Overall Height (inches)	Swivel Lead (inches)	Approx. Wt. (Lbs)	Base Caster Number+
	5	2	1500	6 ¹ / ₂	1 ¹ / ₂	10 ¹ / ₄	62FR05201
	6	2	1500	7 ¹ / ₂	1 ³ / ₄	11	62FR06201
	8	2	1500	10 ¹ / ₈	1 ³ / ₄	14 ¹ / ₂	62FR08201

*Straight Roller (01) and Precision Ball (28) available. Change "01" to other bearing code. Tapered Roller example: 62FR05209.

Note: Ductile Iron Flat Tread (FM) models available. Change FR wheel code to FM. Example: 62FM05201.

Optional Overall Heights all 62 Series Models:

Wheel Diameter	Overall Height	Swivel Lead	Swivel Specify	Rigid Specify
6"	7-3/8"	1-3/4"	HS85	HR85
8"	9-1/2"	2-1/4"	HS76	HR76
8"	9-3/4"	1-3/4"	HS83	HR83



WANT AN EVEN LONGER CASTER LIFE?

Try our **Kingpinless 110 Series** for longer caster life in rugged applications, or where impact and shock cause conventional casters to fail. These durable casters **eliminate kingpin failure**, the most common failure in conventional casters.

See Pages 42 - 44

LOOKING TO IMPROVE ERGONOMICS?

Try our **Precision Ergonomic 18 Series** casters. Designed for ease of movement and no maintenance - making mobility **easier**, employees **safer**, **reducing noise**, and **improving efficiency**.

See Pages 36 - 37



63

Made in the **USA**
Medium Heavy Duty
Casters CAPACITY TO 2000



Premium Quality



Environmentally Friendly



Offering thicker legs and a 3/4" diameter axle, this series improves on our popular 62 series for increased capacity. Manufactured from cold formed steel, this caster can stand up to most heavy duty applications.

MOUNTING OPTION

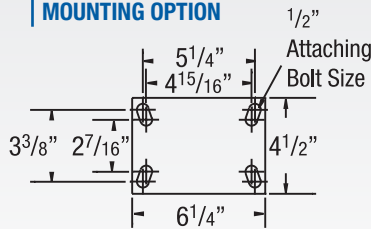

SWIVEL CROSS SECTION

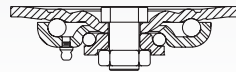

TYPICAL APPLICATIONS

- Movable racks
- Conveyor or "Dragline" operations
- Utility trucks
- Corrugated box trucks

FEATURES

- **Top Plate:** 1/4" steel plate provides the strongest possible section for swivel bearing
- **Swivel Section:** 3-1/4" diameter load race. Raceways are coined smooth and then heat treated to minimize ball indentation and wear
- **Legs:** 3/8" steel plate formed to increase strength and welded to the yoke base inside and out
- **King Bolt:** 3/4" diameter heat treated king bolt and lock nut
- **Axle:** 3/4" diameter axle is hollow with lock nut
- **Lubrication:** Zerk fitting in swivel section and in recessed head of hollow axle
- **Notched Yoke Base:** Notched to accommodate swivel lock.
- Alternate or custom caster configurations available

RIG OPTIONS

- Neoprene **sealed swivel** section specify **NS63**
- **Optional Overall Height** of 9-1/2" available for 8" diameter wheel models. Swivel Lead changes to 2-1/4". For swivel specify **HS84**. For Rigid specify **HR84**

BRAKE OPTIONS

To order, add brake code below to end of model. Example: 63PY06405SSB63



Single Side specify **SSB63**. **Double Sided** specify **DSB63**



Face Contact specify **F**



Face specify **FBB**



Poly Cam specify **P**



Swivel Lock (welded) specify **L**

Hand operated field installable swivel lock order **SL620000** separately



BEARING OPTIONS

Straight Roller (05)



+ For swivel models add "S", for rigid model add "R" to end of base caster number.

	Wheel Diameter (Inches)	Tread Width (Inches)	Capacity (Lbs) (Based on manual operation)	Overall Height (Inches)	Swivel Lead (Inches)	Approx. Wt. (LBS)	Base Caster Number+
MR	6	2 1/2	700	7 1/2	2 1/4	16 1/2	63MR06405
	8	2 1/2	850	10 1/8	2 1/4	17 1/2	63MR08405
	10	2 1/2	950	11 1/2	2 1/4	21	63MR10405
	12	2 1/2	950	13 1/2	2 1/4	24 1/4	63MR12405

	Wheel Diameter (Inches)	Tread Width (Inches)	Capacity (Lbs) (Based on manual operation)	Overall Height (Inches)	Swivel Lead (Inches)	Approx. Wt. (LBS)	Base Caster Number+
PY	5	2 1/2	1300	6 1/2	2 1/4	15	63PY05405
	6	2 1/2	1600	7 1/2	2 1/4	18 1/4	63PY06405
	8	2 1/2	2000	10 1/8	2 1/4	17 1/2	63PY08405
	10	2 1/2	2000	11 1/2	2 1/4	25 3/4	63PY10405
12	2 1/2	2000	13 1/2	2 1/4	30 3/4	63PY12405	

	Wheel Diameter (Inches)	Tread Width (Inches)	Capacity (Lbs) (Based on manual operation)	Overall Height (Inches)	Swivel Lead (Inches)	Approx. Wt. (LBS)	Base Caster Number+
PY 80A	5	2 1/2	1050	6 1/2	2 1/4	15	63PY0540580A
	6	2 1/2	1300	7 1/2	2 1/4	18 1/4	63PY0640580A
	8	2 1/2	1600	10 1/8	2 1/4	17 1/2	63PY0840580A
	10	2 1/2	1840	11 1/2	2 1/4	25 3/4	63PY1040580A
12	2 1/2	2000	13 1/2	2 1/4	30 3/4	63PY1240580A	

To Specify Rigid or Swivel, insert "R" or "S" before "80A". Example: 63PY08228R80A.

+ For swivel models add "S", for rigid model add "R" to end of base caster number.

	Wheel Diameter (Inches)	Tread Width (Inches)	Capacity (Lbs) (Based on manual operation)	Overall Height (Inches)	Swivel Lead (Inches)	Approx. Wt. (LBS)	Base Caster Number+
VY	8	2 1/2	2000	10 1/8	2 1/4	24	63VY08405
	10	2 1/2	2000	11 1/2	2 1/4	27	63VY10405

	Wheel Diameter (Inches)	Tread Width (Inches)	Capacity (Lbs) (Based on manual operation)	Overall Height (Inches)	Swivel Lead (Inches)	Approx. Wt. (LBS)	Base Caster Number+
TM	6	2 1/2	1600	7 1/2	2 1/4	11 1/2	63TM06405
	8	2 1/2	1800	10 1/8	2 1/4	13 3/4	63TM08405
	10	2 1/2	1800	11 1/2	2 1/4	15 3/4	63TM10405
	12	2 1/2	1800	13 1/2	2 1/4	21	63TM12405

	Wheel Diameter (Inches)	Tread Width (Inches)	Capacity (Lbs) (Based on manual operation)	Overall Height (Inches)	Swivel Lead (Inches)	Approx. Wt. (LBS)	Base Caster Number+
CA	5	2 1/2	1800	6 1/2	2 1/4	16 1/4	63CA05405
	6	2 1/2	1800	7 1/2	2 1/4	16 3/4	63CA06405
	8	2 1/2	1800	10 1/8	2 1/4	21	63CA08405
	10	2 1/2	1800	11 1/2	2 1/4	25 1/4	63CA10405
	12	2 1/2	1800	13 1/2	2 1/4	29 1/4	63CA12405

71

Medium Heavy Duty Casters CAPACITY TO 1500



These heavy duty hot forged steel casters are designed for extended life in rugged applications. They will outperform cold forged or stamped steel casters in swivel applications.

TYPICAL APPLICATIONS

- Production racks and fixtures
- Live skids and Box trucks

SWIVEL CROSS SECTION

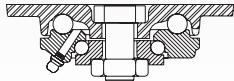

MOUNTING OPTIONS Standard Plate

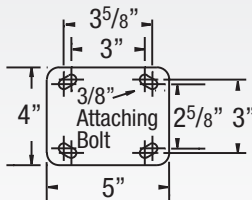

Special Order Plates

Optional H Plate

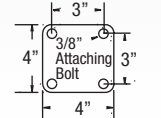

Optional G Plate

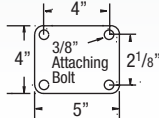

Optional J Plate

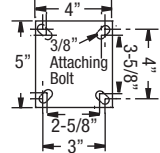

+ For swivel models add "S", for rigid model add "R" to end of base caster number.

Moldon Rubber on Cast Iron (01 Roller Bearing)*

MR	Wheel Diameter (Inches)	Tread Width (Inches)	Capacity (Lbs) (Rated for manual operation)	Overall Height (Inches)	Swivel Lead (Inches)	Approx. Wt. (Lbs)	Base Caster Number+
	4	2	300	5 5/8	1 7/16	7 3/4	71MR04201
	5	2	450	6 1/2	1 13/16	8	71MR05201
	6	2	500	7 1/2	2 1/4	9 3/4	71MR06201
	8	2	600	10 1/8	2 1/4	12	71MR08201

*Precision Ball (28) and Tapered Roller (09) Bearings available. Change "01" to other bearing code. Precision Ball example: 71MR04228.

Heavy Duty Moldon Rubber on Cast Iron (01 Roller Bearing)*

MH	Wheel Diameter (Inches)	Tread Width (Inches)	Capacity (Lbs) (Rated for manual operation)	Overall Height (Inches)	Swivel Lead (Inches)	Approx. Wt. (Lbs)	Base Caster Number+
	5	2	700	6 1/2	1 13/16	8	71MH05201
	6	2	820	7 1/2	2 1/4	9 3/4	71MH06201
	8	2	1000	10 1/8	2 1/4	12	71MH08201

*Precision Ball (28) and Tapered Roller (09) Bearings available. Change "01" to other bearing code. Precision Ball example: 71MH05228.



Premium Quality



Environmentally Friendly

FEATURES

- **Top Plate:** AISI 1045 drop-forged steel for enhanced strength
- **Swivel Section:** Double ball bearing with coined "deep-groove" load and machined component thrust raceway
- **Legs:** 1/4" steel formed to increase strength and welded to the yoke base
- **King Bolt:** 3/4" diameter heat treated bolt and nut for enhanced load capacity
- **Axle:** 1/2" diameter hollow axle with lock nut on straight roller bearings and delrin bearing offerings. Solid axle on ball, and Oilex bearing offerings
- **Lubrication:** Zerk fitting in swivel section and in recessed head of hollow axle
- Alternate or custom caster configurations available

RIG OPTIONS

- **Sealed swivel section** specify **NS71**
- **Heat treated raceway** specify **HT01**
- **NSF** for food service industry specify **NSF**

BRAKE OPTIONS

To order, add brake code below to end of model. Example: 71XS06201**SCB71**

Cam specify **CB71**



Single Side specify **SSB71**. Double Sided specify **DSB71**

Face specify **FBB**



Poly Cam specify **P**



Swivel Lock (welded) specify **L**



Hand operated field installable swivel lock order **SL710000** separately

BEARING OPTIONS



+ For swivel models add "S", for rigid model add "R" to end of base caster number.

Moldon Rubber on Aluminum (01 Roller Bearing)*

MD	Wheel Diameter (Inches)	Tread Width (Inches)	Capacity (Lbs) (Rated for manual operation)	Overall Height (Inches)	Swivel Lead (Inches)	Approx. Wt. (Lbs)	Base Caster Number+
	4	2	400	5 5/8	1 7/16	6 1/2	71MD04201
	5	2	500	6 1/2	1 13/16	7	71MD05201
	6	2	550	7 1/2	2 1/4	7 1/2	71MD06201
	8	2	600	10 1/8	2 1/4	9 1/2	71MD08201

*Precision Ball (28) and Tapered Roller (09) Bearings available. Change "01" to other bearing code. Precision Ball example: 71MD04228.

X-tra Soft Flat Tread (01 Roller Bearing)*

XS	Wheel Diameter (Inches)	Tread Width (Inches)	Capacity (Lbs) (Rated for manual operation)	Overall Height (Inches)	Swivel Lead (Inches)	Approx. Wt. (Lbs)	Base Caster Number+
	4	2	400	5 5/8	1 7/16	5 1/2	71XS04201
	5	2	500	6 1/2	1 13/16	6 1/4	71XS05201
	6	2	600	7 1/2	2 1/4	6 3/4	71XS06201
	8	2	675	10 1/8	2 1/4	8 1/2	71XS08201

Prevenz™ antimicrobial models available. Add PREV to end of caster number.

*Precision Ball (28) Bearings available.

Change "01" to "28" bearing code. Precision Ball example: 71XS04228.

X-tra Soft Round Tread (01 Roller Bearing)*

XR	Wheel Diameter (Inches)	Tread Width (Inches)	Capacity (Lbs) (Rated for manual operation)	Overall Height (Inches)	Swivel Lead (Inches)	Approx. Wt. (Lbs)	Base Caster Number+
	6	2	450	7 1/2	2 1/4	6 3/4	71XR06201
	8	2	600	10 1/8	2 1/4	8 1/2	71XR08201

Prevenz™ antimicrobial models available. Add PREV to end of caster number.

*Precision Ball (28) Bearings available.

Change "01" to "28" bearing code. Precision Ball example: 71XR06228.

Continue on next page >>

71 SERIES • CAPACITY TO 1500

MEDIUM HEAVY DUTY CASTERS

+ For swivel models add "S", for rigid model add "R" to end of base caster number.

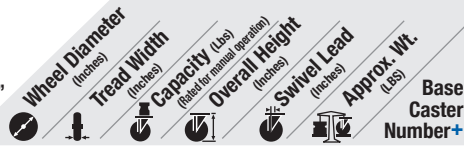

Polyurethane on Aluminum (01 Roller Bearing)							
PD 	4	2	700	5 ⁵ / ₈	17 ¹ / ₁₆	6 ¹ / ₂	71PD04201
	5	2	1050	6 ¹ / ₂	11 ³ / ₁₆	7	71PD05201
	6	2	1230	7 ¹ / ₂	2 ¹ / ₄	7 ¹ / ₂	71PD06201
	8	2	1500	10 ¹ / ₈	2 ¹ / ₄	9 ¹ / ₂	71PD08201

Polyurethane on Aluminum Round Tread (28 Precision Ball Bearing)							
AX 	4	2	800	5 ⁵ / ₈	17 ¹ / ₁₆	5 ¹ / ₂	71AX04228
	5	2	1000	6 ¹ / ₂	11 ³ / ₁₆	5 ³ / ₄	71AX05228
	6	2	1250	7 ¹ / ₂	2 ¹ / ₄	6 ³ / ₄	71AX06228
	8	2	1500	10 ¹ / ₈	2 ¹ / ₄	8 ¹ / ₂	71AX08228
85 Shore A							

Polyurethane on Aluminum Round Tread (28 Precision Ball Bearing)							
PM 	5	2	1000	6 ¹ / ₂	11 ³ / ₁₆	5 ³ / ₄	71PM05228
	6	2	1250	7 ¹ / ₂	2 ¹ / ₄	6 ³ / ₄	71PM06228
	8	2	1500	10 ¹ / ₈	2 ¹ / ₄	8 ¹ / ₂	71PM08228
	95 Shore A						

Polyurethane on Aluminum Round Tread (28 Precision Ball Bearing)							
PM 80A 	5	2	1000	6 ¹ / ₂	11 ³ / ₁₆	5 ³ / ₄	71PM0522880A
	6	2	1250	7 ¹ / ₂	2 ¹ / ₄	6 ³ / ₄	71PM0622880A
	8	2	1500	10 ¹ / ₈	2 ¹ / ₄	8 ¹ / ₂	71PM0822880A
	80 Shore A						

To Specify Rigid or Swivel, insert "R" or "S" before "80A". Example: 71PM08228R80A.

Polyurethane on Cast Iron (01 Roller Bearing)							
PY 	3 ¹ / ₄	2 ³ / ₁₆	420	5 ¹ / ₄	17 ¹ / ₁₆	6 ¹ / ₄	71PY03201
	4	2	750	5 ⁵ / ₈	17 ¹ / ₁₆	8	71PY04201
	5	2	1050	6 ¹ / ₂	11 ³ / ₁₆	8 ³ / ₄	71PY05201
	6	2	1200	7 ¹ / ₂	2 ¹ / ₄	11	71PY06201
8	2	1500	10 ¹ / ₈	2 ¹ / ₄	14	71PY08201	
80A Durometer available, add "80A" to end of caster number. 80A capacity reduced by approximately 20%. Swivel example: 71PY06201S80A.							

Polyurethane on Polypropylene (01 Roller Bearing)							
XA 	4	2	600	5 ⁵ / ₈	17 ¹ / ₁₆	5 ¹ / ₂	71XA04201
	5	2	750	6 ¹ / ₂	11 ³ / ₁₆	6 ¹ / ₄	71XA05201
	6	2	900	7 ¹ / ₂	2 ¹ / ₄	6 ³ / ₄	71XA06201
	8	2	1000	10 ¹ / ₈	2 ¹ / ₄	8 ¹ / ₂	71XA08201
Prevenz™ antimicrobial models available. Add PREV to end of caster number.							

Solid Elastomer (01 Roller Bearing)*							
SE 	4	2	1000	5 ⁵ / ₈	17 ¹ / ₁₆	6 ¹ / ₂	71SE04201
	5	2	1000	6 ¹ / ₂	11 ³ / ₁₆	6 ³ / ₄	71SE05201
	6	2	1000	7 ¹ / ₂	2 ¹ / ₄	7 ³ / ₄	71SE06201
	8	2	1000	10 ¹ / ₈	2 ¹ / ₄	10	71SE08201
Pedestal Precision (29) available. Change "01" to other bearing code. Pedestal Precision example: 71SE04229.							

Glass Filled Polypropylene (01 Roller Bearing)							
RT 	4	2	800	5 ⁵ / ₈	17 ¹ / ₁₆	5 ¹ / ₂	71RT04201
	5	2	1000	6 ¹ / ₂	11 ³ / ₁₆	6 ¹ / ₄	71RT05201
	6	2	1200	7 ¹ / ₂	2 ¹ / ₄	6 ³ / ₄	71RT06201
	8	2	1400	10 ¹ / ₈	2 ¹ / ₄	8 ¹ / ₂	71RT08201

Heavy Duty Glass Filled Nylon (01 Roller Bearing)							
DT 	4	2	1000	5 ⁵ / ₈	17 ¹ / ₁₆	6 ¹ / ₂	71DT04201
	5	2	1200	6 ¹ / ₂	11 ³ / ₁₆	6 ³ / ₄	71DT05201
	6	2	1400	7 ¹ / ₂	2 ¹ / ₄	7 ³ / ₄	71DT06201
	8	2	1500	10 ¹ / ₈	2 ¹ / ₄	10	71DT08201

+ For swivel models add "S", for rigid model add "R" to end of base caster number.

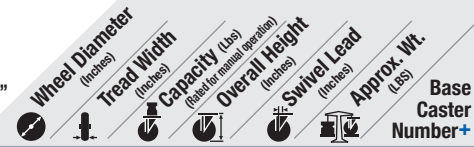



X-Treme™ Plus Solid Polyurethane (01 Roller Bearing)*							
XP 	4	2	1400	5 ⁵ / ₈	17 ¹ / ₁₆	6 ¹ / ₂	71XP04201
	5	2	1200	6 ¹ / ₂	11 ³ / ₁₆	6 ³ / ₄	71XP05201
	6	2	1400	7 ¹ / ₂	2 ¹ / ₄	7 ³ / ₄	71XP06201
	8	2	1200	10 ¹ / ₈	2 ¹ / ₄	10	71XP08201
*Drawn Cup Roller (02), Bronze (22), Pedestal Precision (29). Change "01" to other bearing code. Pedestal Precision example: 71XP04229.							

Phenolic (01 Roller Bearing)							
TM 	3 ¹ / ₄	2	700	5 ¹ / ₄	17 ¹ / ₁₆	6	71TM03201
	4	2	800	5 ⁵ / ₈	17 ¹ / ₁₆	6 ¹ / ₂	71TM04201
	5	2	1000	6 ¹ / ₂	11 ³ / ₁₆	6 ³ / ₄	71TM05201
	6	2	1200	7 ¹ / ₂	2 ¹ / ₄	7 ³ / ₄	71TM06201
8	2	1400	10 ¹ / ₈	2 ¹ / ₄	10	71TM08201	

Maxim® (01 Roller Bearing)*							
NG 	3 ¹ / ₄	2	700	5 ¹ / ₄	17 ¹ / ₁₆	6	71NG03201
	4	2	800	5 ⁵ / ₈	17 ¹ / ₁₆	6 ¹ / ₂	71NG04201
	5	2	1000	6 ¹ / ₂	11 ³ / ₁₆	6 ³ / ₄	71NG05201
	6	2	1200	7 ¹ / ₂	2 ¹ / ₄	7 ³ / ₄	71NG06201
8	2	1400	10 ¹ / ₈	2 ¹ / ₄	10	71NG08201	

Prevenz™ antimicrobial models available. Add PREV to end of model. *Drawn Cup Roller (02), Bronze (22), Pedestal Precision (29). Change "01" to other bearing code. Pedestal Precision example: 71NG04229.

Trionix™ High Impact Polymer (28 Precision Ball Bearing)							
NX 	4	2	1500	5 ⁵ / ₈	17 ¹ / ₁₆	6 ¹ / ₂	71NX04228
	5	2	1500	6 ¹ / ₂	11 ³ / ₁₆	7	71NX05228
	6	2	1500	7 ¹ / ₂	2 ¹ / ₄	7 ¹ / ₂	71NX06228
	8	2	1500	10 ¹ / ₈	2 ¹ / ₄	9 ¹ / ₂	71NX08228

Cast Iron (01 Roller Bearing)							
CA 	3 ¹ / ₄	2	700	5 ¹ / ₄	17 ¹ / ₁₆	8 ¹ / ₄	71CA03201
	4	17 ⁸ / ₁₆	1000	5 ⁵ / ₈	17 ¹ / ₁₆	8 ¹ / ₄	71CA04201
	5	17 ⁸ / ₁₆	1300	6 ¹ / ₂	1 ¹ / ₂	9 ¹ / ₄	71CA05201
	6	17 ⁸ / ₁₆	1400	7 ¹ / ₂	2 ¹ / ₄	11 ¹ / ₄	71CA06201
8	2	1500	10 ¹ / ₈	2 ¹ / ₄	14 ¹ / ₂	71CA08201	

Heavy Duty Cast Iron (01 Roller Bearing)							
CH 	5	2	1500	6 ¹ / ₂	1 ¹ / ₂	10	71CH05201
	6	2	1500	7 ¹ / ₂	2 ¹ / ₄	12	71CH06201
	8	2	1500	10 ¹ / ₈	2 ¹ / ₄	15	71CH08201

Drop Forged Steel (01 Roller Bearing)*							
FS 	4	1 ¹ / ₂	1400	5 ⁵ / ₈	17 ¹ / ₁₆	8 ¹ / ₄	71FS04101
	5	1 ³ / ₄	1500	6 ¹ / ₂	1 ¹ / ₂	10 ¹ / ₄	71FS05201
	6	2	1500	7 ¹ / ₂	2 ¹ / ₄	11 ¹ / ₄	71FS06201
*Tapered Roller bearings (09) available. Change "01" to other bearing code. Example: 71FS04109.							

Ductile Iron Crowned Tread (01 Roller Bearing)							
FR, FM 	5	2	1500	6 ¹ / ₂	1 ¹ / ₂	10	71FR05201
	6	2	1500	7 ¹ / ₂	2 ¹ / ₄	12	71FR06201
	8	2	1500	10 ¹ / ₈	2 ¹ / ₄	15	71FR08201
	*Roller (09) and Precision Ball (28) bearings available. Change "01" to other bearing code. Tapered Roller example: 71FR05209. Note: Ductile Iron Flat Tread (FM) models available. Change FR wheel code to FM. Example: 71FM05201.						



Premium Quality



Environmentally Friendly

72

Medium Heavy Duty Casters

CAPACITY TO 1600



This heavy duty hot forged steel caster is designed for extended life in rugged applications. They will outperform cold forged or stamped steel casters in swivel applications requiring severe service.

MOUNTING OPTIONS Standard Plate

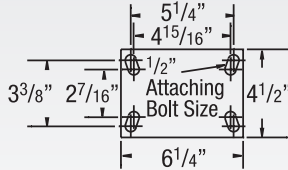

Special Order Plates

Optional D Plate

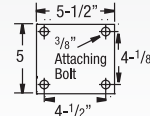

Optional W Plate

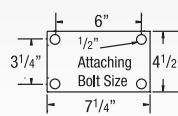

TYPICAL APPLICATIONS

- Production racks and fixtures
- Live skids and Box trucks

SWIVEL CROSS SECTION

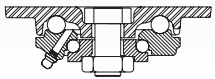

FEATURES

- **Top Plate:** Rugged AISI 1045 Drop forged steel for maximum strength
- **Swivel Section:** Double ball bearing "deep-groove" load and machined component thrust raceways
- **Legs:** 1/4" steel, engineered to increase strength and welded construction
- **King Bolt:** 3/4" diameter heat treated bolt and nut for enhanced load capacity
- **Axle:** 1/2" diameter, hollow, with lock nut. Solid axle on ball, and Oilex bearings
- **Lubrication:** Zerk fitting in swivel section and in recessed head of hollow axle
- Alternate or custom caster configurations available

RIG OPTIONS

- Neoprene **sealed swivel** section specify **NS72**
- **Heat treated raceway** specify **HT02**
- **Hollow axle** for plain bore and Oilex applications specify **ZF07** (For up to 2" wide wheels)
- **NSF Listed** for food service industry specify **NSF**

BRAKE OPTIONS

To order, add brake code below to end of model. Example: 72XS06201**SCB72**

Cam specify **CB72**



Single Side specify **SSB72**. Double Sided specify **DSB72**



Swivel Lock (welded) specify **L**



BEARING OPTIONS



	Wheel Diameter (Inches)	Tread Width (Inches)	Capacity (Lbs) (Rated for manual operation)	Overall Height (Inches)	Swivel Lead (Inches)	Approx. Wt. (Lbs)	Base Caster Number+
--	-------------------------	----------------------	---	-------------------------	----------------------	-------------------	---------------------

Moldon Rubber on Cast Iron (01, 07 Roller Bearing)

MR	4	2	300	5 ⁵ / ₈	1 ⁷ / ₁₆	8	72MR04201
	5	2	450	6 ¹ / ₂	1 ¹³ / ₁₆	8 ¹ / ₂	72MR05201
	6	2	500	7 ¹ / ₂	2 ¹ / ₄	9	72MR06201
	6	2 ¹ / ₂	700	7 ¹ / ₂	2 ¹ / ₄	15 ¹ / ₂	72MR06407
	8	2	600	10 ¹ / ₈	2 ¹ / ₄	14	72MR08201
	8	2 ¹ / ₂	850	10 ¹ / ₈	2 ¹ / ₄	16 ³ / ₄	72MR08407
10	2 ¹ / ₂	950	11 ¹ / ₂	2 ¹ / ₄	20 ³ / ₄	72MR10407	

Heavy Duty Moldon Rubber on Cast Iron (01, 07 Roller Bearing)

MH	5	2	700	6 ¹ / ₂	1 ¹³ / ₁₆	8 ¹ / ₂	72MH05201
	6	2	820	7 ¹ / ₂	2 ¹ / ₄	9	72MH06201
	8	2	1000	10 ¹ / ₈	2 ¹ / ₄	14	72MH08201
	8	2 ¹ / ₂	1300	10 ¹ / ₈	2 ¹ / ₄	16 ³ / ₄	72MH08407
	10	2 ¹ / ₂	1500	11 ¹ / ₂	2 ¹ / ₄	20 ³ / ₄	72MH10407

Moldon Rubber on Aluminum (01 Roller Bearing)

MD	4	2	400	5 ⁵ / ₈	1 ⁷ / ₁₆	8	72MD04201
	5	2	500	6 ¹ / ₂	1 ¹³ / ₁₆	8 ¹ / ₂	72MD05201
	6	2	550	7 ¹ / ₂	2 ¹ / ₄	9	72MD06201
	8	2	600	10 ¹ / ₈	2 ¹ / ₄	11 ¹ / ₄	72MD08201

+ For swivel models add "S", for rigid model add "R" to end of base caster number.

	Wheel Diameter (Inches)	Tread Width (Inches)	Capacity (Lbs) (Rated for manual operation)	Overall Height (Inches)	Swivel Lead (Inches)	Approx. Wt. (Lbs)	Base Caster Number+
--	-------------------------	----------------------	---	-------------------------	----------------------	-------------------	---------------------

X-tra Soft Flat Tread (01 Roller Bearing)*

XS	4	2	400	5 ⁵ / ₈	1 ⁷ / ₁₆	7 ¹ / ₄	72XS04201
	5	2	500	6 ¹ / ₂	1 ¹³ / ₁₆	7 ³ / ₄	72XS05201
	6	2	600	7 ¹ / ₂	2 ¹ / ₄	8 ¹ / ₂	72XS06201
	8	2	675	10 ¹ / ₈	2 ¹ / ₄	10 ¹ / ₄	72XS08201

Prevenz™ antimicrobial models available. Add PREV to end of model.

*Precision Ball (28) Bearings available.

Change "01" to "28" bearing code. Precision Ball example: 72XS04228.

X-tra Soft Round Tread (01 Roller Bearing)*

XR	6	2	450	7 ¹ / ₂	2 ¹ / ₄	8 ¹ / ₁	72XR06201
	8	2	600	10 ¹ / ₈	2 ¹ / ₄	10 ¹ / ₄	72XR08201

Prevenz™ antimicrobial models available. Add PREV to end of model.

*Precision Ball (28) bearings available.

Change "01" to "28" bearing code. Precision Ball example: 72XR06228.

Continue on next page >>

72 SERIES • CAPACITY TO 1600

MEDIUM HEAVY DUTY CASTERS

72 Series Continued

+ For swivel models add "S", for rigid model add "R" to end of base caster number.

		Wheel Diameter (Inches)	Tread Width (Inches)	Capacity (Lbs) (Rated for manual operation)	Overall Height (Inches)	Swivel Lead (Inches)	Approx. Wt. (Lbs)	Base Caster Number+
Polyurethane on Aluminum Crown Tread (01 Roller Bearing)								
PD 	4	2	700	55/8	17/16	73/4	72PD04201	
	5	2	1050	61/2	113/16	81/2	72PD05201	
	6	2	1230	71/2	21/4	9	72PD06201	
	8	2	1500	101/8	21/4	11	72PD08201	

		Wheel Diameter (Inches)	Tread Width (Inches)	Capacity (Lbs) (Rated for manual operation)	Overall Height (Inches)	Swivel Lead (Inches)	Approx. Wt. (Lbs)	Base Caster Number+
Polyurethane on Cast Iron (01 Roller Bearing)								
PI 	6	2 1/2	1200	7 1/2	2 1/4	12 1/2	72PI06401	
	8	2 1/2	1500	10 1/8	2 1/4	16	72PI08401	
	10	2 1/2	1500	11 1/2	2 1/4	17	72PI10401	

		Wheel Diameter (Inches)	Tread Width (Inches)	Capacity (Lbs) (Rated for manual operation)	Overall Height (Inches)	Swivel Lead (Inches)	Approx. Wt. (Lbs)	Base Caster Number+
Polyurethane on Aluminum Round Tread (28 Precision Ball Bearing)								
AX 	4	2	800	55/8	17/16	9	72AX04228	
	5	2	1000	61/2	113/16	8 1/4	72AX05228	
	6	2	1250	71/2	21/4	9 1/4	72AX06228	
	8	2	1500	10 1/8	2 1/4	12 1/4	72AX08228	
85 Shore A								

		Wheel Diameter (Inches)	Tread Width (Inches)	Capacity (Lbs) (Rated for manual operation)	Overall Height (Inches)	Swivel Lead (Inches)	Approx. Wt. (Lbs)	Base Caster Number+
Polyurethane on Aluminum Round Tread (28 Precision Ball Bearing)								
PM 	5	2	1000	61/2	113/16	8 1/4	72PM05228	
	6	2	1250	71/2	21/4	9 1/4	72PM06228	
	8	2	1500	10 1/8	2 1/4	12 1/4	72PM08228	
95 Shore A								

		Wheel Diameter (Inches)	Tread Width (Inches)	Capacity (Lbs) (Rated for manual operation)	Overall Height (Inches)	Swivel Lead (Inches)	Approx. Wt. (Lbs)	Base Caster Number+
Polyurethane on Cast Iron (01 & 07 Roller Bearing)								
PY 	4	2	750	55/8	21/4	103/4	72PY04201	
	5	2	1050	61/2	113/16	83/4	72PY05201	
	6	2	1200	71/2	21/4	123/4	72PY06201	
	6	2 1/2	1600	71/2	21/4	133/4	72PY06407	
	8	2	1500	10 1/8	2 1/4	16 1/2	72PY08201	
	8	2 1/2	1600	10 1/8	2 1/4	17 1/2	72PY08407	
10	2 1/2	1600	11 1/2	2 1/4	19	72PY10407		
80A Durometer available, add "80A" to end of caster number. 80A capacity reduced by approximately 20%. Swivel example: 16PY06201S80A.								

		Wheel Diameter (Inches)	Tread Width (Inches)	Capacity (Lbs) (Rated for manual operation)	Overall Height (Inches)	Swivel Lead (Inches)	Approx. Wt. (Lbs)	Base Caster Number+
Polyurethane on Polypropylene (01 Roller Bearing)								
XA 	4	2	600	55/8	17/16	7 1/4	72XA04201	
	5	2	750	61/2	113/16	73/4	72XA05201	
	6	2	900	71/2	21/4	8 1/2	72XA06201	
	8	2	1000	10 1/8	2 1/4	10 1/4	72XA08201	
Prevenz™ antimicrobial models available. Add PREV to end of caster number.								

		Wheel Diameter (Inches)	Tread Width (Inches)	Capacity (Lbs) (Rated for manual operation)	Overall Height (Inches)	Swivel Lead (Inches)	Approx. Wt. (Lbs)	Base Caster Number+
X-Treme™ Solid Polyurethane (01 Roller Bearing)*								
XI 	4	2	1000	55/8	17/16	7 1/2	72XI04201	
	5	2	1000	61/2	113/16	8 1/2	72XI05201	
	6	2	1000	71/2	21/4	9 1/2	72XI06201	
	8	2	1000	10 1/8	2 1/4	11 3/4	72XI08201	
*Drawn Cup Roller (02), Bronze (22), Pedestal Precision (29) bearings available. Change "01" to other bearing code. Pedestal Precision example: 72XI04229.								

		Wheel Diameter (Inches)	Tread Width (Inches)	Capacity (Lbs) (Rated for manual operation)	Overall Height (Inches)	Swivel Lead (Inches)	Approx. Wt. (Lbs)	Base Caster Number+
X-Treme™ Plus Solid Polyurethane (28 Precision Ball Bearing)*								
XP 	4	2	1400	55/8	17/16	7 1/2	72XP04228	
	5	2	1200	61/2	113/16	8 1/2	72XP05228	
	6	2	1400	71/2	21/4	9 1/2	72XP06228	
	8	2	1200	10 1/8	2 1/4	10	72XP08228	
*Drawn Cup Roller (02), Bronze (22), Pedestal Precision (29) bearings available. Change "01" to other bearing code. Pedestal Precision example: 72XP04229.								

+ For swivel models add "S", for rigid model add "R" to end of base caster number.

		Wheel Diameter (Inches)	Tread Width (Inches)	Capacity (Lbs) (Rated for manual operation)	Overall Height (Inches)	Swivel Lead (Inches)	Approx. Wt. (Lbs)	Base Caster Number+
Phenolic (01, 07 Roller Bearing)								
TM 	4	2	800	55/8	17/16	7 1/2	72TM04201	
	5	2	1000	61/2	113/16	8 1/2	72TM05201	
	6	2	1200	71/2	21/4	9 1/2	72TM06201	
	6	2 1/2	1600	71/2	21/4	10 3/4	72TM06407	
	8	2	1400	10 1/8	2 1/4	11 3/4	72TM08201	
	8	2 1/2	1600	10 1/8	2 1/4	13 1/4	72TM08407	
	10	2 1/2	1600	11 1/2	2 1/4	15	72TM10407	

		Wheel Diameter (Inches)	Tread Width (Inches)	Capacity (Lbs) (Rated for manual operation)	Overall Height (Inches)	Swivel Lead (Inches)	Approx. Wt. (Lbs)	Base Caster Number+
Maxim® (01 Roller Bearing)*								
NG 	4	2	800	55/8	17/16	7 1/2	72NG04201	
	5	2	1000	61/2	113/16	8 1/2	72NG05201	
	6	2	1200	71/2	21/4	9 1/2	72NG06201	
	8	2	1400	10 1/8	2 1/4	11 3/4	72NG08201	

Prevenz™ antimicrobial models available.
Add PREV to end of model.

*Drawn Cup Roller (02), Bronze (22), Pedestal Precision (29) bearings available.
Change "01" to other bearing code. Pedestal Precision example: 72NG04229.

		Wheel Diameter (Inches)	Tread Width (Inches)	Capacity (Lbs) (Rated for manual operation)	Overall Height (Inches)	Swivel Lead (Inches)	Approx. Wt. (Lbs)	Base Caster Number+
Trionix™ High Impact Polymer (28 Precision Ball Bearing)								
NX 	4	2	1600	55/8	17/16	9	72NX04228	
	5	2	1600	61/2	113/16	10 1/2	72NX05228	
	6	2	1600	71/2	21/4	12 1/2	72NX06228	
	6	2 1/2	1600	71/2	21/4	13	72NX06428	
	8	2	1600	10 1/8	2 1/4	15 3/4	72NX08228	
	8	2 1/2	1600	10 1/8	2 1/4	16 1/4	72NX08428	

		Wheel Diameter (Inches)	Tread Width (Inches)	Capacity (Lbs) (Rated for manual operation)	Overall Height (Inches)	Swivel Lead (Inches)	Approx. Wt. (Lbs)	Base Caster Number+
Cast Iron (01 & 07 Roller Bearing)								
CA 	4	17/8	1000	55/8	17/16	9 1/4	72CA04201	
	5	17/8	1300	61/2	113/16	10 3/4	72CA05201	
	6	17/8	1400	71/2	21/4	12 3/4	72CA06201	
	6	2 1/2	1600	71/2	21/4	16 1/2	72CA06407	
	8	2	1600	10 1/8	2 1/4	16	72CA08201	
	8	2 1/2	1600	10 1/8	2 1/4	18 1/4	72CA08407	

		Wheel Diameter (Inches)	Tread Width (Inches)	Capacity (Lbs) (Rated for manual operation)	Overall Height (Inches)	Swivel Lead (Inches)	Approx. Wt. (Lbs)	Base Caster Number+
Heavy Duty Cast Iron (01 Roller Bearing)								
CH 	5	2	1500	61/2	113/16	11 3/4	72CH05201	
	6	2	1600	71/2	21/4	14	72CH06201	
	8	2	1600	10 1/8	2 1/4	17	72CH08201	

		Wheel Diameter (Inches)	Tread Width (Inches)	Capacity (Lbs) (Rated for manual operation)	Overall Height (Inches)	Swivel Lead (Inches)	Approx. Wt. (Lbs)	Base Caster Number+
Drop Forged Steel (01 Roller Bearing)*								
FS 	4	1 1/2	1400	55/8	17/16	9 1/4	72FS04101	
	5	1 3/4	1500	61/2	113/16	12	72FS05201	
	6	2	1600	71/2	21/4	13	72FS06201	
*Tapered Roller bearings (09) available. Change "01" to other bearing code. Example: 72FS04109.								

		Wheel Diameter (Inches)	Tread Width (Inches)	Capacity (Lbs) (Rated for manual operation)	Overall Height (Inches)	Swivel Lead (Inches)	Approx. Wt. (Lbs)	Base Caster Number+
Ductile Iron Crowned Tread (01 Roller Bearing)*								
FR, FM 	5	2	1500	61/2	113/16	11 3/4	72FR05201	
	6	2	1600	71/2	21/4	14	72FR06201	
	6	2 1/2	1600	71/2	21/4	15	72FR06401	
	8	2	1600	10 1/8	2 1/4	17	72FR08201	
*Tapered Roller (09) and Precision Ball (28) bearings available. Change "01" to other bearing code. Tapered Roller example: 72FR05209. Note: Ductile Iron Flat Tread (FM) models available. Change FR wheel code to FM. Example: 72FM05201.								

MAINTENANCE FREE MEDIUM HEAVY DUTY CASTERS

CAPACITY RANGE 350-2000 LBS



Ergonomic



Maintenance Free

Common Applications:

- Production Racks and Carts
- Conveyor Systems
- Part Carts
- Tool Dollies
- Floor Trucks
- Warehouse Trucks
- Distribution Cages and Carts

68 Series

Ergonomic Maintenance Free Caster
with AX Wheel



18 Series Maintenance Free
Capacity to 1250 **36-37**



68 Series Maintenance Free
Capacity to 2000 **38-39**

Maintenance Free Advantage

- Ergonomically designed
- Easier push/pull force
- Quieter operation
- Reduced maintenance costs
- Long life in towing application (68 Series)

Maintenance Free Rig + AX Wheel = Preferred Ergonomic Solution

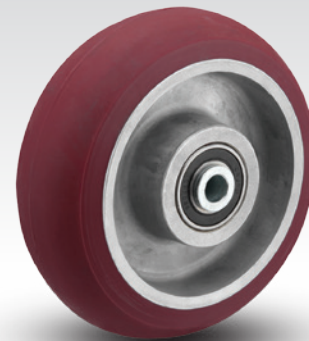
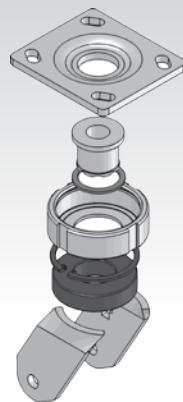

**SEALED PRECISION SWIVEL BEARING
PROVIDES EXCELLENT ERGONOMICS
WITH NO MAINTENANCE**
• UP TO 2,000 LBS. CAPACITY

- EASIEST MOVEMENT
- REDUCES NOISE
- DEBRIS RESISTANT
- FLOOR PROTECTIVE

MAINTENANCE FREE MEDIUM HEAVY DUTY

18

Ergonomic Precision Casters

CAPACITY TO 1250



New Ergonomic AX Wheels Now Available



Ergonomic



Maintenance Free



Premium Quality



Environmentally Friendly

Ergonomically designed for ease of movement and quiet mobility. Sealed precision swivel bearing is maintenance free and significantly reduces push/pull force, keeping equipment operators safer and improving efficiency.

TYPICAL APPLICATIONS

- Picking carts
- Light towing carts
- JIT Carts
- AGV & tow line applications

MOUNTING OPTIONS

Standard Plate

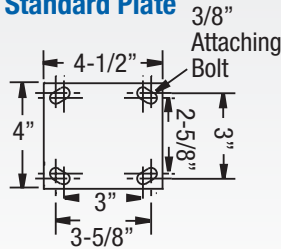

Special Order Plate*

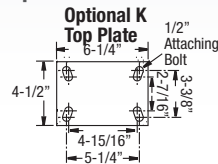

* K Plate available on 6" and 8" wheel diameter models; consult factory

MAINTENANCE FREE SWIVEL CROSS SECTION

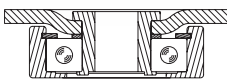

FEATURES

- **Top Plate & Yoke Base:** Cold formed from 1/4" steel plate. Yoke base is notched for factory or field-installable 4-position swivel lock
- **Swivel Section:** Precision sealed ball bearing eliminates need for routine maintenance
- **Legs:** 1/4" steel, formed to increase strength and welded on inside and outside of yoke base (swivel only)
- **Axle:** 1/2" diameter solid axle with Lock Nut
- **Maintenance Free:** Lubrication unnecessary with maintenance free swivel section and wheel bearing design
- **Finish:** All parts, except wheel, are zinc plated

BEARING OPTIONS

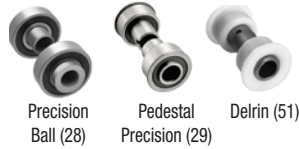

Precision Ball (28)

Pedestal Precision (29)

Delrin (51)

BRAKE OPTIONS

To order, add brake code below to end of model. Example: 18XS06229S**FBC**

Face specify **FBC**



Face specify **FBB**



Face specify **FBE**



Hand operated field installable swivel lock specify **L**

Foot operated field installable swivel lock order **SL160002** separately



- Sealed Precision Swivel
- Maintenance Free Operation
- Smooth, Quiet Ride

+ For swivel models add "S", for rigid model add "R" to end of base caster number.

	Wheel Diameter (Inches)	Tread Width (Inches)	Capacity (Lbs) (Based on manual operation)	Overall Height (Inches)	Swivel Lead (Inches)	Approx. Wt. (Lbs)	Base Caster Number+
MG	4	2	500	5 ⁵ / ₈	11 ¹¹ / ₁₆		18MG04229
	5	2	600	6 ¹ / ₂	15 ⁵ / ₈		18MG05229
	6	2	700	7 ¹ / ₂	13 ³ / ₄		18MG06229
	8	2	700	9 ¹ / ₂	13 ³ / ₄		18MG08229

	Wheel Diameter (Inches)	Tread Width (Inches)	Capacity (Lbs) (Based on manual operation)	Overall Height (Inches)	Swivel Lead (Inches)	Approx. Wt. (Lbs)	Base Caster Number+
NP	5	2	600	6 ¹ / ₂	15 ⁵ / ₈		18NP05228
	6	2	700	7 ¹ / ₂	13 ³ / ₄		18NP06228
	8	2	700	9 ¹ / ₂	13 ³ / ₄		18NP08228

+ For swivel models add "S", for rigid model add "R" to end of base caster number.

X-tra Soft (Flat Tread) (29 Pedestal Precision Bearing)*

	Wheel Diameter (Inches)	Tread Width (Inches)	Capacity (Lbs) (Based on manual operation)	Overall Height (Inches)	Swivel Lead (Inches)	Approx. Wt. (Lbs)	Base Caster Number+
XS	4	2	350	5 ⁵ / ₈	11 ¹¹ / ₁₆	6 ¹ / ₄	18XS04229
	5	2	375	6 ¹ / ₂	15 ⁵ / ₈	7	18XS05229
	6	2	600	7 ¹ / ₂	13 ³ / ₄	6 ¹ / ₂	18XS06229
	8	2	675	9 ¹ / ₂	13 ³ / ₄	7 ¹ / ₂	18XS08229

Prevenz™ antimicrobial models available. Add PREV to end of caster number. *Precision Ball (28) bearings available. Change "29" to other bearing code. Precision Ball example: 18XS04228.

X-tra Soft (Round Tread) (29 Pedestal Precision Bearing)*

	Wheel Diameter (Inches)	Tread Width (Inches)	Capacity (Lbs) (Based on manual operation)	Overall Height (Inches)	Swivel Lead (Inches)	Approx. Wt. (Lbs)	Base Caster Number+
XR	6	2	450	7 ¹ / ₂	13 ³ / ₄	6 ¹ / ₂	18XR06229
	8	2	600	9 ¹ / ₂	13 ³ / ₄	7 ¹ / ₂	18XR08229

Prevenz™ antimicrobial models available. Add PREV to end of caster number. *Precision Ball (28) bearings available. Change "29" to other bearing code. Precision Ball example: 18XR04228.

Continue on next page >>

+ For swivel models add "S", for rigid model add "R" to end of base caster number.

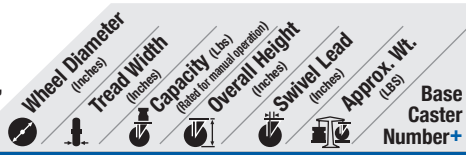

Polyurethane on Aluminum Flat Tread (29 Pedestal Precision)*

Model	Wheel Diameter (inches)	Tread Width (inches)	Capacity (lbs)	Overall Height (inches)	Swivel Lead (inches)	Approx. Wt. (lbs)	Base Caster Number
PD 	4	1 1/2	600	5 5/8	1 11/16	5 1/2	18PD04129
	4	2	700	5 5/8	1 11/16	6	18PD04229
	5	1 1/2	720	6 1/2	1 5/8	6	18PD05129
	5	2	1050	6 1/2	1 5/8	6 1/4	18PD05229
	6	2	1230	7 1/2	1 3/4	6 3/4	18PD06229
	8	2	1250	9 1/2	1 3/4	8	18PD08229

*Precision Ball (28) Bearings available. Change "29" to other bearing code. Precision Ball example: 18PD04228.

Aubin Industries Swivel-EAZ® Crown Tread (28 Precision Ball Bearing)

Model	Wheel Diameter (inches)	Tread Width (inches)	Capacity (lbs)	Overall Height (inches)	Swivel Lead (inches)	Approx. Wt. (lbs)	Base Caster Number
EY 	4	2	675	5 5/8	1 11/16		18EY05228
	5	2	900	6 1/2	1 5/8		18EY05228
	6	2	1250	7 1/2	1 3/4		18EY06228
	8	2	1250	9 1/2	1 3/4		18EY08228

Aubin Industries Swivel-EAZ® Flat Tread (28 Precision Ball Bearing)

Model	Wheel Diameter (inches)	Tread Width (inches)	Capacity (lbs)	Overall Height (inches)	Swivel Lead (inches)	Approx. Wt. (lbs)	Base Caster Number
EZ 	4	2	900	5 5/8	1 11/16		18EZ05228
	5	2	1250	6 1/2	1 5/8		18EZ05228
	6	2	1250	7 1/2	1 3/4		18EZ06228
	8	2	1250	9 1/2	1 3/4		18EZ08228

Polyurethane on Aluminum Round Tread (28 Precision Ball Bearing)

Model	Wheel Diameter (inches)	Tread Width (inches)	Capacity (lbs)	Overall Height (inches)	Swivel Lead (inches)	Approx. Wt. (lbs)	Base Caster Number
AX 	4	2	800	5 5/8	1 11/16	5 1/2	18AX04228
	5	2	1000	6 1/2	1 5/8	6	18AX05228
	6	2	1250	7 1/2	1 3/4	7	18AX06228
	8	2	1250	9 1/2	1 3/4	9	18AX08228

85 Shore A

Polyurethane on Aluminum Round Tread (28 Precision Ball Bearing)

Model	Wheel Diameter (inches)	Tread Width (inches)	Capacity (lbs)	Overall Height (inches)	Swivel Lead (inches)	Approx. Wt. (lbs)	Base Caster Number
PM 	5	2	1000	6 1/2	1 5/8	6	18PM05228
	6	2	1250	7 1/2	1 3/4	7	18PM06228
	8	2	1250	9 1/2	1 3/4	9	18PM08228

95 Shore A

Polyurethane on Aluminum Round Tread (28 Precision Ball Bearing)

Model	Wheel Diameter (inches)	Tread Width (inches)	Capacity (lbs)	Overall Height (inches)	Swivel Lead (inches)	Approx. Wt. (lbs)	Base Caster Number
PM 80A 	5	2	1000	6 1/2	1 5/8	6	18PM0522880A
	6	2	1250	7 1/2	1 3/4	7	18PM0622880A
	8	2	1250	9 1/2	1 3/4	9	18PM0822880A

80 Shore A

To Specify Rigid or Swivel, insert "R" or "S" before "80A". Example: 18PM06228R80A.

Polyurethane on Polypropylene (29 Pedestal Precision)*

Model	Wheel Diameter (inches)	Tread Width (inches)	Capacity (lbs)	Overall Height (inches)	Swivel Lead (inches)	Approx. Wt. (lbs)	Base Caster Number
XA 	4	2	700	5 5/8	1 11/16	5 1/4	18XA04229
	5	2	750	6 1/2	1 5/8	5 3/4	18XA05229
	6	2	900	7 1/2	1 3/4	6 1/2	18XA06229
	8	2	1000	9 1/2	1 3/4	8 1/2	18XA08229

Prevenz™ antimicrobial models available. Add PREV to end of caster number. *Precision Ball (28) bearings available. Change "29" to other bearing code. Precision Ball example: 18XA04228.

X-Treme™ Solid Polyurethane (29 Pedestal Precision)*

Model	Wheel Diameter (inches)	Tread Width (inches)	Capacity (lbs)	Overall Height (inches)	Swivel Lead (inches)	Approx. Wt. (lbs)	Base Caster Number
XI 	4	2	1000	5 5/8	1 11/16	6	18XI04229
	5	2	1000	6 1/2	1 5/8	6 1/2	18XI05229
	6	2	1000	7 1/2	1 3/4	7 1/4	18XI06229
	8	2	1000	9 1/2	1 3/4	9	18XI08229

*Precision Ball (28) bearings available. Change "29" to other bearing code. Precision Ball example: 18XI04228.

+ For swivel models add "S", for rigid model add "R" to end of base caster number.

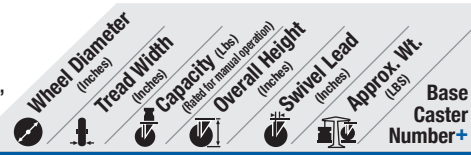

X-Treme™ Plus Solid Polyurethane (29 Pedestal Precision)*

Model	Wheel Diameter (inches)	Tread Width (inches)	Capacity (lbs)	Overall Height (inches)	Swivel Lead (inches)	Approx. Wt. (lbs)	Base Caster Number
XP 	4	2	1250	5 5/8	1 11/16	6	18XP04229
	5	2	1200	6 1/2	1 5/8	6 1/2	18XP05229
	6	2	1250	7 1/2	1 3/4	7 1/4	18XP06229
	8	2	1200	9 1/2	1 3/4	9	18XP08229

*Precision Ball (28) bearings available. Change "29" to other bearing code. Precision Ball example: 18XP04228.

Solid Elastomer (28 Precision Ball Bearing)*

Model	Wheel Diameter (inches)	Tread Width (inches)	Capacity (lbs)	Overall Height (inches)	Swivel Lead (inches)	Approx. Wt. (lbs)	Base Caster Number
SE 	4	2	1000	5 5/8	1 11/16	6	18SE04228
	5	2	1000	6 1/2	1 5/8	6 1/2	18SE05228
	6	2	1100	7 1/2	1 3/4	7 1/4	18SE06228
	8	2	1200	9 1/2	1 3/4	9	18SE08228

*Delrin (51) bearings available. Change "28" to other bearing code. Delrin example: 18SE04251.

Maxim® (29 Pedestal Precision Bearing)*

Model	Wheel Diameter (inches)	Tread Width (inches)	Capacity (lbs)	Overall Height (inches)	Swivel Lead (inches)	Approx. Wt. (lbs)	Base Caster Number
NG 	3 1/4	2	800	5 1/4	1 11/16	6	18NG03229
	4	2	800	5 5/8	1 11/16	6	18NG04229
	5	2	1000	6 1/2	1 5/8	6 1/2	18NG05229
	6	2	1200	7 1/2	1 3/4	7 1/4	18NG06229
	8	2	1250	9 1/2	1 3/4	9	18NG08229

Prevenz™ antimicrobial models available. Add PREV to end of caster number. *Precision Ball (28) bearings available. Change "29" to other bearing code. Precision Ball example: 18NG04228.

White Nylon (29 Pedestal Precision Bearing)*

Model	Wheel Diameter (inches)	Tread Width (inches)	Capacity (lbs)	Overall Height (inches)	Swivel Lead (inches)	Approx. Wt. (lbs)	Base Caster Number
NW 	5	2	600	6 1/2	1 5/8	6 1/2	18NW05229
	6	2	900	7 1/2	1 3/4	7 1/4	18NW06229
	8	2	1100	9 1/2	1 3/4	9	18NW08229

*Delrin (51) bearings available. Change "29" to other bearing code. Delrin example: 18NW04251.

Heavy Duty Glass Filled Nylon (28 Precision Ball Bearing)

Model	Wheel Diameter (inches)	Tread Width (inches)	Capacity (lbs)	Overall Height (inches)	Swivel Lead (inches)	Approx. Wt. (lbs)	Base Caster Number
DT 	4	2	800	5 5/8	1 11/16		18DT04228
	5	2	1000	6 1/2	1 5/8		18DT05228
	6	2	1200	7 1/2	1 3/4		18DT06228
	8	2	1250	9 1/2	1 3/4		18DT08228

Trionix™ High Impact Polymer (28 Precision Ball Bearing)

Model	Wheel Diameter (inches)	Tread Width (inches)	Capacity (lbs)	Overall Height (inches)	Swivel Lead (inches)	Approx. Wt. (lbs)	Base Caster Number
NX 	4	2	1250	5 5/8	1 11/16	8	18NX04228
	5	2	1250	6 1/2	1 5/8	9	18NX05228
	6	2	1250	7 1/2	1 3/4	10 3/4	18NX06228
	8	2	1250	9 1/2	1 3/4	11	18NX08228

68

Maintenance Free Kingpinless Casters

CAPACITY TO 2000



Ergonomic



Maintenance Free



Premium Quality



Towing[^]

FEATURES

- **Top Plate & Yoke Base:** Cold formed from 5/16" steel plate.
- **Swivel Section:** Precision sealed ball bearing eliminates need for routine maintenance
- **Legs:** 5/16" steel, formed to increase strength and welded on inside and outside of yoke base
- **Axle:** 1/2" diameter solid axle with lock nut
- **Finish:** Yellow zinc dichromate
- **Maintenance Free:** Lubrication unnecessary with maintenance free swivel section and wheel bearing design
- Alternate or custom caster configurations available

BEARING OPTIONS



Precision Ball (28)

Pedestal Precision (29)

Specifically designed for the rugged use at automotive plants, this series is exceptional for towing and impact applications when durability is needed. Special construction provides extremely smooth operation at all times.

MOUNTING OPTIONS

Standard Plate

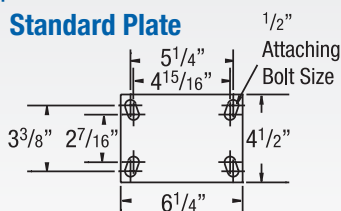

Special Order Plates

Optional J Plate

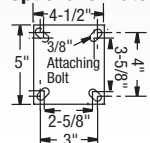

TYPICAL APPLICATIONS

- Towing
- Just-In-Time Manufacturing
- Tilt Carts

SWIVEL CROSS SECTION Maintenance Free



+ For swivel models add "S", for rigid model add "R" to end of base caster number.

Neoprene on Aluminum (28 Precision Ball Bearing)

	Wheel Diameter (Inches)	Tread Width (Inches)	Capacity (Lbs) (Based on normal operation)	Overall Height (Inches)	Swivel Lead (Inches)	Approx. Wt. (Lbs)	Base Caster Number+
NP	6	2	700	8 1/4	1 3/4	10	68NP06228
	8	2	700	10 1/4	2 5/16	14	68NP08228

Aubin Industries Swivel-EAZ® Round Tread (28 Precision Ball Bearing)

	Wheel Diameter (Inches)	Tread Width (Inches)	Capacity (Lbs) (Based on normal operation)	Overall Height (Inches)	Swivel Lead (Inches)	Approx. Wt. (Lbs)	Base Caster Number+
EY*	6	2	1425	8 1/4	1 3/4	10	68EY06228
	8	2	2000	10 1/4	2 5/16	14	68EY08228

Crowned Tread

*Additional durometers available; consult factory.

Aubin Industries Swivel-EAZ® Flat Tread (28 Precision Ball Bearing)

	Wheel Diameter (Inches)	Tread Width (Inches)	Capacity (Lbs) (Based on normal operation)	Overall Height (Inches)	Swivel Lead (Inches)	Approx. Wt. (Lbs)	Base Caster Number+
EZ*	6	2	1900	8 1/4	1 3/4	10	68EZ06228
	8	2	2000	10 1/4	2 5/16	14	68EZ08228

*Additional durometers available; consult factory.

ERGONOMIC

- Easy Push/Pull
- Easy Turning
- Reduces Noise
- Improves Efficiency

+ For swivel models add "S", for rigid model add "R" to end of base caster number.

Polyurethane on Aluminum (28 Precision Ball Bearing)

	Wheel Diameter (Inches)	Tread Width (Inches)	Capacity (Lbs) (Based on normal operation)	Overall Height (Inches)	Swivel Lead (Inches)	Approx. Wt. (Lbs)	Base Caster Number+
PM	6	2	1250	8 1/4	1 3/4	10	68PM06228
	8	2	1500	10 1/4	2 5/16	14	68PM08228

Polyurethane on Aluminum (28 Precision Ball Bearing)*

	Wheel Diameter (Inches)	Tread Width (Inches)	Capacity (Lbs) (Based on normal operation)	Overall Height (Inches)	Swivel Lead (Inches)	Approx. Wt. (Lbs)	Base Caster Number+
PM 80A	6	2	1250	8 1/4	1 3/4	10	68PM0622880A
	8	2	1500	10 1/4	2 5/16	14	68PM0822880A

To Specify Rigid or Swivel, insert "R" or "S" before "80A".
Example: 68PM08228R80A.

Continue on next page >>

+ For swivel models add "S", for rigid model add "R" to end of base caster number.



Polyurethane on Aluminum (28 Precision Ball Bearing)

AX	6	2	1250	8 1/4	1 3/4	10	68AX06228
	8	2	1500	10 1/4	2 5/16	14	68AX08228

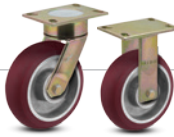

Polyurethane on Cast Iron (28 Precision Ball Bearing)*

PY	6	2	1200	8 1/4	1 3/4	12	68PY06228
	8 <td>2</td> <td>1500</td> <td>10 1/4</td> <td>2 5/16</td> <td>16</td> <td>68PY08228</td>	2	1500	10 1/4	2 5/16	16	68PY08228



*Pedestal Precision (29) Ball Bearings available. Change "28" to other bearing code. Example: 68PY06229.

Polyurethane on Cast Iron (28 Precision Ball Bearing)*

PY 80A	6	2	960	8 1/4	1 3/4	12	68PY0622880A
	8 <td>2</td> <td>1200</td> <td>10 1/4</td> <td>2 5/16</td> <td>16</td> <td>68PY0822880A</td>	2	1200	10 1/4	2 5/16	16	68PY0822880A

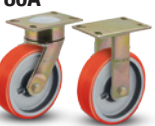

To Specify Rigid or Swivel, insert "R" or "S" before "80A". Example: 68PM08228R80A.

*Pedestal Precision Ball (29) Bearings available. Change "28" to other bearing code. Example: 68PY0622980A.

Trionix™ High Impact Polymer (28 Precision Ball Bearing)

NX	6	2	2000	8 1/4	1 3/4	11	68NX06228
	8 <td>2</td> <td>2000</td> <td>10 1/4</td> <td>2 5/16</td> <td>15</td> <td>68NX08228</td>	2	2000	10 1/4	2 5/16	15	68NX08228



+ For swivel models add "S", for rigid model add "R" to end of base caster number.



Vulkollan® on Cast Iron Core (28 Precision Ball Bearing)*

VX	6	2	1500	8 1/4	1 3/4	12	68VX06228
	8 <td>2</td> <td>1800</td> <td>10 1/4</td> <td>2 5/16</td> <td>16</td> <th>68VX08228</th>	2	1800	10 1/4	2 5/16	16	68VX08228



*Pedestal Precision Ball (29) Bearings available. Change "28" to other bearing code. Example: 68VX06229.

Solid Elastomer (28 Precision Bearing)

SE	6	2	1100	8 1/4	1 3/4	10	68SE06228
	8 <td>2</td> <th>1200</th> <th>10 1/4</th> <th>2 5/16</th> <th>14</th> <th>68SE08228</th>	2	1200	10 1/4	2 5/16	14	68SE08228



X-treme™ Plus Solid Polyurethane (28 Precision Bearing)*

XP	6	2	1400	8 1/4	1 3/4	10	68XP06228
	8 <td>2</td> <th>1200</th> <th>10 1/4</th> <th>2 5/16</th> <th>14</th> <th>68XP08228</th>	2	1200	10 1/4	2 5/16	14	68XP08228



*Pedestal Precision Ball (29) Bearings available. Change "28" to other bearing code. Example: 68XP06229.

Heavy Duty Glass Filled Nylon (28 Precision Ball Bearing)*

DT	6	2	1200	8 1/4	1 3/4	9	68DT06228
	8 <td>2</td> <th>1400</th> <th>10 1/4</th> <th>2 5/16</th> <th>13</th> <th>68DT08228</th>	2	1400	10 1/4	2 5/16	13	68DT08228



*Pedestal Precision Ball (29) Bearings available. Change "28" to other bearing code. Example: 68DT06229.

Excellent ergonomic casters for Automotive and Aerospace Industries

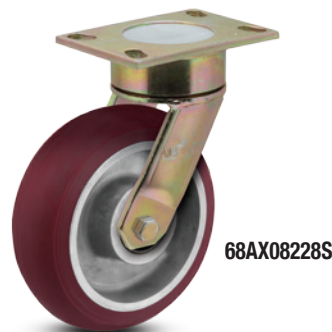

WHY KINGPINLESS?

Kingpinless casters *eliminate*
kingpin failure.

Kingpinless casters are particularly well-suited for any type of power-towed applications where impact and shock loading cause failure in conventional king bolt and nut swivel casters.

A caster with a “kingpin” is the most common, traditional style swivel caster. All the elements that work together to let the caster swivel are held together by one kingpin. In high impact applications, the kingpin becomes strained over time and will fail rendering the caster useless.

A kingpinless caster has a precision machined inner raceway, where large ball bearings are held in between the top plate and yoke base. This allows for greater load distribution, easier swiveling, and eliminates the number one cause of swivel caster failure.

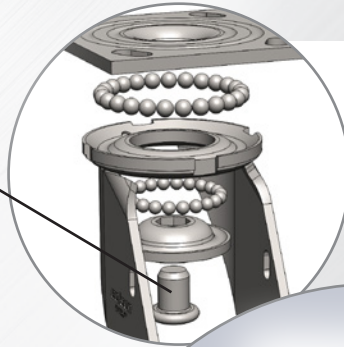

85% of Caster failures are due to **Kingpin Failure.**

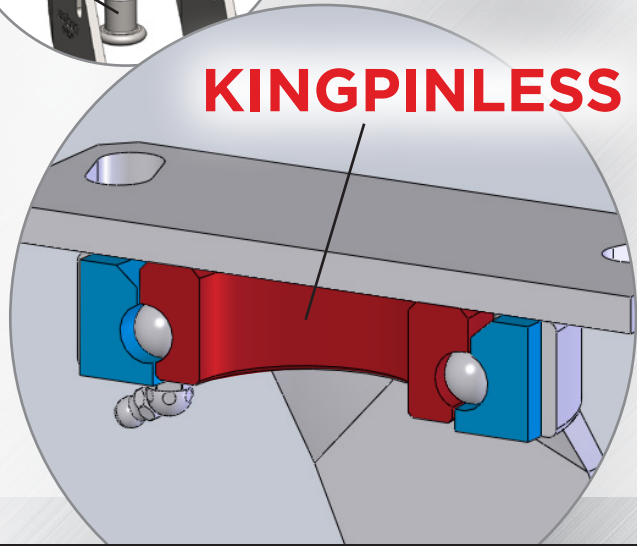

Contender Kingpinless Models



Single Wheel
Pages 41 - 58



Dual Wheel
Pages 105 - 108



Spring Loaded
Pages 93 - 99

Albion's leading lineup of kingpinless casters are ready to keep you rolling longer, and eliminate the issue you may have with conventional kingpin style casters that simply can't hold up to your rugged application. Available in single, dual, and spring loaded - we have your heavy duty needs covered all the way up to 30,000 lbs.!

Stainless Kingpinless



Sometimes even heavy duty casters need protection from the elements - and Albion offers the leading stainless selection of kingpinless casters. Prevent corrosion, maintain clean and safe operations, and keep on rolling in the toughest of environments.

Pages 75-86



HEAVY DUTY KINGPINLESS CASTERS

CAPACITY RANGE 300-20000 LBS



410 Contender Series
Heavy Duty Kingpinless Caster

Common Applications:

- Conveyor-Drawn Tow-Trucks
- Heavy Duty Bakery Racks
- Production Dollies
- Heavy Duty Dough Troughs
- Body Dolly Carts
- Engine Dollies
- Material Carts
- Aircraft Maintenance Stands
- Aircraft Engine Stands



110 Contender Series
Capacity to 200042-44



610 Contender Series
Capacity to 950052-53



170 Economy Series
Capacity to 150046-47



600 Shockmaster Series
Capacity to 1000054-55



310 Contender Series
Capacity to 410048-49



410 Contender Series
Capacity to 540050-51

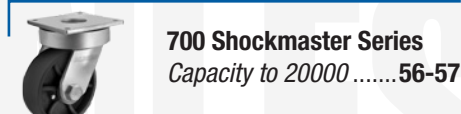

700 Shockmaster Series
Capacity to 2000056-57

HEAVY DUTY KINGPINLESS

Premium and Specialty Heavy Duty Kingpinless Casters That May Interest You ...

STAINLESS STEEL CASTERS



If your heavy duty casters are exposed to cleaning agents, steam, water, caustic solutions or other agents that cause rust, switch to Stainless Steel to extend your caster life (pages 75-86).

KINGPINLESS SPRING LOADED CASTERS



If you need casters that offer spring loaded protection from damaging shock, unwanted vibration and noise levels, see the Spring Loaded Section (pages 93-99).

110

Contender™ Kingpinless Casters

CAPACITY TO 2000



Precision raceways and fully heat treated construction make the 110 Series the ideal solution for applications exposed to rugged conditions or high amounts of impact and shock. More durable than competitors' case or induction hardened construction, and longer lasting than conventional kingpin designs.

TYPICAL APPLICATIONS

- Dollies
- Dough troughs
- Platform trucks
- Tow line
- Utility carts
- Tooling fixtures
- Scrap metal carriers

SWIVEL CROSS SECTION

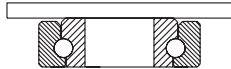

MOUNTING OPTIONS Standard Plate

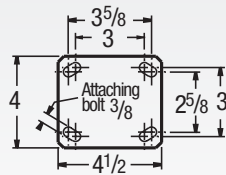

Special Order Plate

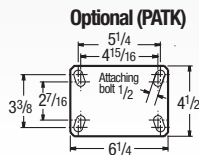

Consult factory for additional mounting options



FEATURES

- 3 Year warranty
- **Top Plate:** 5/16" AISI 1045 steel welded and heat treated for longer life
- **Yoke Base:** Notched AISI 1045 steel
- **Swivel Section:** One row of 3/8" ball bearings mounted in a heat treated precision machined raceway. Zerk in swivel section
- **Axle:** 1/2" diameter hollow axle with zerk fitting on roller and tapered bearing models (Solid axle on Delrin, precision ball, and Oilex models)
- **Finish:** Zinc plating
- Alternate or custom caster configurations available

BEARING OPTIONS



Consult factory for additional bearing options.

STAINLESS STEEL OPTION

See pages 80-81.



RIG OPTIONS

- **Optional overall heights** of 9 1/2" for 8" wheel diameter models add **-01** to end of caster number
- **Optional swivel leads** of 2-1/4" for 6" casters add **-018** to end of model number. Optional swivel lead of 3-1/2" for 8" casters add **-02**

BRAKE OPTIONS

To order, add brake code below to end of caster number. Example: 110XS06201SCB110

Cam specify **CB110**



PLB Integrated specify **PLB**

Single Side specify **SSB110**. Double Sided specify **DSB110**



Face specify **FBB**

Face specify **FBC** (Not available with swivel lock)



Face specify **FBE**

Poly Cam specify **P**



Hand operated field installable swivel lock specify **L**

Foot operated field installable swivel lock order **SL160002** separately



+ For swivel models add "S", for rigid model add "R" to end of base caster number.

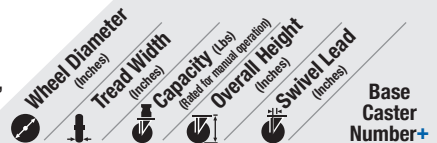

Heavy Duty Moldon Rubber on Cast Iron (01 Roller Bearing)

MH	Wheel Diameter (inches)	Tread Width (inches)	Capacity (Lbs) (Rated for manual operation)	Overall Height (inches)	Swivel Lead (inches)	Base Caster Number+
	5	2	700	6 1/2	1 3/8	110MH05201
	6	2	820	7 1/2	1 9/16	110MH06201
	8	2	1000	10 1/8	2 1/4	110MH08201

X-tra Soft Flat Tread (29 Pedestal Precision Bearing)*

XS	Wheel Diameter (inches)	Tread Width (inches)	Capacity (Lbs) (Rated for manual operation)	Overall Height (inches)	Swivel Lead (inches)	Base Caster Number+
	4	2	400	5 5/8	1 3/16	110XS04229
	5	2	500	6 1/2	1 3/8	110XS05229
	6	2	600	7 1/2	1 9/16	110XS06229
	8	2	675	10 1/8	2 1/4	110XS08229

*All 110 bearings listed are available. Precision example: 110XS05229.

X-tra Soft Round Tread (29 Pedestal Precision Bearing)*

XR	Wheel Diameter (inches)	Tread Width (inches)	Capacity (Lbs) (Rated for manual operation)	Overall Height (inches)	Swivel Lead (inches)	Base Caster Number+
	6	2	450	7 1/2	1 9/16	110XR06229
	8	2	600	10 1/8	2 1/4	110XR08229

Prevenz™ antimicrobial models available. Add PREV to end of caster number.

*Precision ball (28) bearings available.

Change "01" to other bearing code. Example: 110XR06228.

+ For swivel models add "S", for rigid model add "R" to end of base caster number.

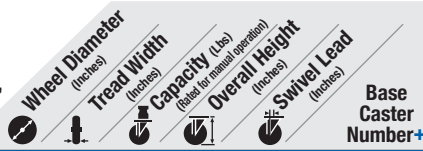

Polypropylene (01 Roller Bearing)*

Wheel Diameter (Inches)	Tread Width (Inches)	Capacity (lbs) (Rigid or normal operation)	Overall Height (Inches)	Swivel Lead (Inches)	Base Caster Number+
4	2	450	5 ⁵ / ₈	1 ³ / ₁₆	110PB04201
5	2	650	6 ¹ / ₂	1 ³ / ₈	110PB05201
6	2	750	7 ¹ / ₂	1 ⁹ / ₁₆	110PB06201
8	2	1000	10 ¹ / ₈	2 ¹ / ₄	110PB08201

Plain bore (41) available. Change "01" to other code. Plain bore example: 110RR04241. If plain bore specified 5" diameter capacity is 450 lbs, 6" diameter is 650 lbs, 8" diameter is 850 lbs.

Retort High Temp Polypropylene (01 Roller Bearing)

Wheel Diameter (Inches)	Tread Width (Inches)	Capacity (lbs) (Rigid or normal operation)	Overall Height (Inches)	Swivel Lead (Inches)	Base Caster Number+
4	2	500	5 ⁵ / ₈	1 ³ / ₁₆	110RW04201
5	2	650	6 ¹ / ₂	1 ³ / ₈	110RW05201
6	2	700	7 ¹ / ₂	1 ⁹ / ₁₆	110RW06201
8	2	900	10 ¹ / ₈	2 ¹ / ₄	110RW08201

Polyurethane on Aluminum Flat Tread (01 Roller Bearing)

Wheel Diameter (Inches)	Tread Width (Inches)	Capacity (lbs) (Rigid or normal operation)	Overall Height (Inches)	Swivel Lead (Inches)	Base Caster Number+
4	2	700	5 ⁵ / ₈	1 ³ / ₁₆	110PD04201
5	2	1050	6 ¹ / ₂	1 ³ / ₈	110PD05201
6	2	1230	7 ¹ / ₂	1 ⁹ / ₁₆	110PD06201
8	2	1500	10 ¹ / ₈	2 ¹ / ₄	110PD08201

Polyurethane on Cast Iron (28 Precision Ball Bearing)*

Wheel Diameter (Inches)	Tread Width (Inches)	Capacity (lbs) (Rigid or normal operation)	Overall Height (Inches)	Swivel Lead (Inches)	Base Caster Number+
4	2	750	5 ⁵ / ₈	1 ³ / ₁₆	110PY04201**
5	2	1050	6 ¹ / ₂	1 ³ / ₈	110PY05228
6	2	1200	7 ¹ / ₂	1 ⁹ / ₁₆	110PY06228
8	2	1500	10 ¹ / ₈	2 ¹ / ₄	110PY08228

*Available with Precision Ball (28) bearings (**except 4" diameter models which are not available with (28) bearing, Roller (01) bearing shown). Change "28" or "01" to other bearing code. Example: 110PY05229.

Polyurethane on Cast Iron (28 Precision Ball Bearing)*

Wheel Diameter (Inches)	Tread Width (Inches)	Capacity (lbs) (Rigid or normal operation)	Overall Height (Inches)	Swivel Lead (Inches)	Base Caster Number+
4	2	600	5 ⁵ / ₈	1 ³ / ₁₆	110PY0420180A**
5	2	840	6 ¹ / ₂	1 ³ / ₈	110PY0522880A
6	2	960	7 ¹ / ₂	1 ⁹ / ₁₆	110PY0622880A
8	2	1200	10 ¹ / ₈	2 ¹ / ₄	110PY0822880A

To Specify Rigid or Swivel, insert "R" or "S" before "80A". Example: 110PY04201R80A.
*Available with Precision Ball (28) bearings (**except 4" diameter models which are not available with (28) bearing, Roller (01) bearing shown). Change "28" or "01" to other bearing code. Example: 110PY0522980A.

Aubin Industries Swivel-EAZ® Crown Tread (28 Prec. Ball Bearing)

Wheel Diameter (Inches)	Tread Width (Inches)	Capacity (lbs) (Rigid or normal operation)	Overall Height (Inches)	Swivel Lead (Inches)	Base Caster Number+
4	2	675	5 ⁵ / ₈	1 ³ / ₁₆	110EY04228
5	2	900	6 ¹ / ₂	1 ³ / ₈	110EY05228
6	2	1425	7 ¹ / ₂	1 ⁹ / ₁₆	110EY06228
8	2	2000	10 ¹ / ₈	2 ¹ / ₄	110EY08228

Aubin Industries Swivel-EAZ® Flat Tread (28 Precision Ball Bearing)

Wheel Diameter (Inches)	Tread Width (Inches)	Capacity (lbs) (Rigid or normal operation)	Overall Height (Inches)	Swivel Lead (Inches)	Base Caster Number+
4	2	900	5 ⁵ / ₈	1 ³ / ₁₆	110EZ04228
5	2	1400	6 ¹ / ₂	1 ³ / ₈	110EZ05228
6	2	1900	7 ¹ / ₂	1 ⁹ / ₁₆	110EZ06228
8	2	2000	10 ¹ / ₈	2 ¹ / ₄	110EZ08228

Polyurethane on Aluminum Round Tread (28 Precision Ball Bearing)

Wheel Diameter (Inches)	Tread Width (Inches)	Capacity (lbs) (Rigid or normal operation)	Overall Height (Inches)	Swivel Lead (Inches)	Base Caster Number+
4	2	700	5 ⁵ / ₈	1 ³ / ₁₆	110AX04228
5	2	1000	6 ¹ / ₂	1 ³ / ₈	110AX05228
6	2	1250	7 ¹ / ₂	1 ⁹ / ₁₆	110AX06228
8	2	1500	10 ¹ / ₈	2 ¹ / ₄	110AX08228

85 Shore A

Polyurethane on Aluminum Round Tread (28 Precision Ball Bearing)

Wheel Diameter (Inches)	Tread Width (Inches)	Capacity (lbs) (Rigid or normal operation)	Overall Height (Inches)	Swivel Lead (Inches)	Base Caster Number+
5	2	1000	6 ¹ / ₂	1 ³ / ₈	110PM05228
6	2	1250	7 ¹ / ₂	1 ⁹ / ₁₆	110PM06228
8	2	1500	10 ¹ / ₈	2 ¹ / ₄	110PM08228

95 Shore A

+ For swivel models add "S", for rigid model add "R" to end of base caster number.

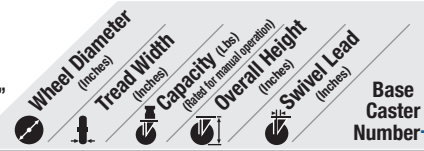

Polyurethane on Aluminum Round Tread (28 Precision Ball Bearing)

Wheel Diameter (Inches)	Tread Width (Inches)	Capacity (lbs) (Rigid or normal operation)	Overall Height (Inches)	Swivel Lead (Inches)	Base Caster Number+
5	2	1000	6 ¹ / ₂	1 ³ / ₈	110PM0522880A
6	2	1250	7 ¹ / ₂	1 ⁹ / ₁₆	110PM0622880A
8	2	1500	10 ¹ / ₈	2 ¹ / ₄	110PM0822880A

80 Shore A To Specify Rigid or Swivel, insert "R" or "S" before "80A". Ex: 110PM08228R80A.

Polyurethane on Heavy Duty Cast Iron (28 Precision Ball Bearing)

Wheel Diameter (Inches)	Tread Width (Inches)	Capacity (lbs) (Rigid or normal operation)	Overall Height (Inches)	Swivel Lead (Inches)	Base Caster Number+
6	2	2000	7 ¹ / ₂	1 ⁹ / ₁₆	110PF06228
8	2	2000	10 ¹ / ₈	2 ¹ / ₄	110PF08228

95 Shore A

Magnum Polyurethane on Aluminum Round Tread (28 Prec. Ball Bearing)

Wheel Diameter (Inches)	Tread Width (Inches)	Capacity (lbs) (Rigid or normal operation)	Overall Height (Inches)	Swivel Lead (Inches)	Base Caster Number+
4	2	700	5 ⁵ / ₈	1 ³ / ₁₆	110UA04228
6	2	750	7 ¹ / ₂	1 ⁹ / ₁₆	110UA06228
8	2	900	10 ¹ / ₈	2 ¹ / ₄	110UA08228

Blue Shore 95A Standard
 UA Black Shore 70A 4"=400 capacity 6"=410 capacity 8"=500 capacity
 UA Red Shore 80A 4"=500 capacity 6"=500 capacity 8"=800 capacity
 UA Orange Shore 73D 4"=900 capacity 6"=1,000 capacity 8"=1,200 capacity

To order color/durometer enter durometer code at end of model. Red wheel example: 110UA08228S80A. To specify Rigid or Swivel, insert "R" or "S" before last 3 digit durometer code. Ex: 110UA08228R80A.

Polyurethane on Polypropylene (29 Pedestal Precision Bearing)

Wheel Diameter (Inches)	Tread Width (Inches)	Capacity (lbs) (Rigid or normal operation)	Overall Height (Inches)	Swivel Lead (Inches)	Base Caster Number+
4	2	600	5 ⁵ / ₈	1 ³ / ₁₆	110XA04229
5	2	750	6 ¹ / ₂	1 ³ / ₈	110XA05229
6	2	900	7 ¹ / ₂	1 ⁹ / ₁₆	110XA06229
8	2	1200	10 ¹ / ₈	2 ¹ / ₄	110XA08229

Prevenz™ antimicrobial models available.

X-Treme™ Plus Solid Polyurethane (29 Pedestal Precision Bearing)*

Wheel Diameter (Inches)	Tread Width (Inches)	Capacity (lbs) (Rigid or normal operation)	Overall Height (Inches)	Swivel Lead (Inches)	Base Caster Number+
4	2	1400	5 ⁵ / ₈	1 ³ / ₁₆	110XP04229
5	2	1200	6 ¹ / ₂	1 ³ / ₈	110XP05229
6	2	1400	7 ¹ / ₂	1 ⁹ / ₁₆	110XP06229
8	2	1200	10 ¹ / ₈	2 ¹ / ₄	110XP08229

*All 110 bearings listed are available. Precision Ball Bearing example: 110XP04228.

Solid Elastomer (28 Precision Ball Bearing)

Wheel Diameter (Inches)	Tread Width (Inches)	Capacity (lbs) (Rigid or normal operation)	Overall Height (Inches)	Swivel Lead (Inches)	Base Caster Number+
4	2	1000	5 ⁵ / ₈	1 ³ / ₁₆	110SE04228
5	2	1000	6 ¹ / ₂	1 ³ / ₈	110SE05228
6	2	1200	7 ¹ / ₂	1 ⁹ / ₁₆	110SE06228
8	2	1200	10 ¹ / ₈	2 ¹ / ₄	110SE08228

Phenolic (01 Roller Bearing)

Wheel Diameter (Inches)	Tread Width (Inches)	Capacity (lbs) (Rigid or normal operation)	Overall Height (Inches)	Swivel Lead (Inches)	Base Caster Number+
4	2	800	5 ⁵ / ₈	1 ³ / ₁₆	110TM04201
5	2	1000	6 ¹ / ₂	1 ³ / ₈	110TM05201
6	2	1200	7 ¹ / ₂	1 ⁹ / ₁₆	110TM06201
8	2	1400	10 ¹ / ₈	2 ¹ / ₄	110TM08201

Straight Sided Phenolic (01 Roller Bearing)

Wheel Diameter (Inches)	Tread Width (Inches)	Capacity (lbs) (Rigid or normal operation)	Overall Height (Inches)	Swivel Lead (Inches)	Base Caster Number+
4	2	1000	5 ⁵ / ₈	1 ³ / ₁₆	110TH04201
5	2	1200	6 ¹ / ₂	1 ³ / ₈	110TH05201
6	2	1500	7 ¹ / ₂	1 ⁹ / ₁₆	110TH06201

Maxim® (01 Roller Bearing)*

Wheel Diameter (Inches)	Tread Width (Inches)	Capacity (lbs) (Rigid or normal operation)	Overall Height (Inches)	Swivel Lead (Inches)	Base Caster Number+
4	2	800	5 ⁵ / ₈	1 ³ / ₁₆	110NG04201
5	2	1000	6 ¹ / ₂	1 ³ / ₈	110NG05201
6	2	1200	7 ¹ / ₂	1 ⁹ / ₁₆	110NG06201
8	2	1400	10 ¹ / ₈	2 ¹ / ₄	110NG08201

*Pedestal Precision ball (29) bearings available. Change "01" to other bearing code. Example: 110NG06229.

+ For swivel models add "S", for rigid model add "R" to end of base caster number.

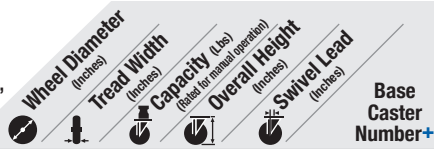

White Nylon (01 Roller Bearing)*

NW	Wheel Diameter (inches)	Tread Width (inches)	Capacity (lbs) (rated for manual operation)	Overall Height (inches)	Swivel Lead (inches)	Base Caster Number+
5	2	600	6 1/2	1 3/8	110NW05201	
6	2	900	7 1/2	1 9/16	110NW06201	
8	2	1100	10 1/8	2 1/4	110NW08201	

*Bearings, Pedestal Precision Ball (29) Bearings or plain bore (41) models available. Change "01" to other bearing code. Plain Bore example: 110NW05241.

Glass Filled Polypropylene (01 Roller Bearing)*

RT	Wheel Diameter (inches)	Tread Width (inches)	Capacity (lbs) (rated for manual operation)	Overall Height (inches)	Swivel Lead (inches)	Base Caster Number+
4	2	800	5 5/8	1 3/16	110RT04201	
5	2	1000	6 1/2	1 3/8	110RT05201	
6	2	1200	7 1/2	1 9/16	110RT06201	
8	2	1400	10 1/8	2 1/4	110RT08201	

*Plain Bore (41), Precision ball (28) and Pedestal Precision Ball (29) bearings available. Change "01" to other bearing code. Plain Bore example: 110RT04241.

Heavy Duty Glass Filled Nylon (29 Pedestal Precision Bearing)*

DT	Wheel Diameter (inches)	Tread Width (inches)	Capacity (lbs) (rated for manual operation)	Overall Height (inches)	Swivel Lead (inches)	Base Caster Number+
4	2	1000	5 5/8	1 3/16	110DT04229	
5	2	1200	6 1/2	1 3/8	110DT05229	
6	2	1400	7 1/2	1 9/16	110DT06229	
8	2	1600	10 1/8	2 1/4	110DT08229	

*Plain Bore (41), Roller (01) and Precision Ball (28) bearings available. Change "29" to other bearing code. Precision Ball example: 110DT04228.

High Temp Glass Filled Nylon (01 Roller Bearing)*

HT	Wheel Diameter (inches)	Tread Width (inches)	Capacity (lbs) (rated for manual operation)	Overall Height (inches)	Swivel Lead (inches)	Base Caster Number+
4	2	800	5 5/8	1 3/16	110HT04201	
5	2	1000	6 1/2	1 3/8	110HT05201	
6	2	1200	7 1/2	1 9/16	110HT06201	
8	2	1400	10 1/8	2 1/4	110HT08201	

*Plain Bore (41) available. Change "01" to other bearing code. Example: 110HT04241.

Trionix™ High Impact Polymer (28 Precision Ball Bearing)

NX	Wheel Diameter (inches)	Tread Width (inches)	Capacity (lbs) (rated for manual operation)	Overall Height (inches)	Swivel Lead (inches)	Base Caster Number+
4	2	2000	5 5/8	1 3/16	110NX04228	
5	2	2000	6 1/2	1 3/8	110NX05228	
6	2	2000	7 1/2	1 9/16	110NX06228	
8	2	2000	10 1/8	2 1/4	110NX08228	

+ For swivel models add "S", for rigid model add "R" to end of base caster number.

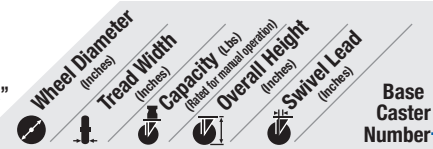

Cast Iron (01 Roller Bearing)

CA	Wheel Diameter (inches)	Tread Width (inches)	Capacity (lbs) (rated for manual operation)	Overall Height (inches)	Swivel Lead (inches)	Base Caster Number+
4	1 7/8	1000	5 5/8	1 3/16	110CA04201	
5	1 7/8	1300	6 1/2	1 3/8	110CA05201	
6	1 7/8	1400	7 1/2	1 9/16	110CA06201	
8	2	1800	10 1/8	2 1/4	110CA08201	

Heavy Duty Cast Iron (01 Roller Bearing)

CH	Wheel Diameter (inches)	Tread Width (inches)	Capacity (lbs) (rated for manual operation)	Overall Height (inches)	Swivel Lead (inches)	Base Caster Number+
5	2	1500	6 1/2	1 3/8	110CH05201	
6	2	1700	7 1/2	1 9/16	110CH06201	
8	2	1800	10 1/8	2 1/4	110CH08201	

Drop Forged Steel (01 Roller Bearing)

FS	Wheel Diameter (inches)	Tread Width (inches)	Capacity (lbs) (rated for manual operation)	Overall Height (inches)	Swivel Lead (inches)	Base Caster Number+
4	1 1/2	1400	5 5/8	1 3/16	110FS04101	
5	1 3/4	1500	6 1/2	1 3/8	110FS05201	
6	2	1700	7 1/2	1 9/16	110FS06201	

V-Grooved Cast Iron (01 Roller Bearing)

VG	Wheel Diameter (inches)	Tread Width (inches)	Capacity (lbs) (rated for manual operation)	Overall Height (inches)	Swivel Lead (inches)	Base Caster Number+
4	2	800	5 5/8	1 3/16	110VG04201	
5	2	800	6 1/2	1 3/8	110VG05201	
6	2	1000	7 1/2	1 9/16	110VG06201	

Ductile Iron Crowned Tread (01 Roller Bearing)*

FR, FM	Wheel Diameter (inches)	Tread Width (inches)	Capacity (lbs) (rated for manual operation)	Overall Height (inches)	Swivel Lead (inches)	Base Caster Number+
5	2	1500	6 1/2	1 3/8	110FR05201	
6	2	2000	7 1/2	1 9/16	110FR06201	
8	2	2000	10 1/8	2 1/4	110FR08201	

*Precision Ball (28) bearings available. Change "01" to other bearing code. Example: 110FR05228
Note: Ductile Iron Flat Tread (FM) models available. Change FR wheel code to FM. Example: 110FM05201.



Need even more load capacity?

Check out our USA Made 310 and 410 Series Kingpinless Casters – also featuring an industry leading 3 Year Warranty:

310 Series (up to 4,100 lb. capacity each) – pages **48-49**

410 Series (up to 5,400 lb. capacity each) – pages **50-51**

ALBION®

the caster experts

Made in the **USA**

INTRODUCING THE
LASER CUT
CONTENDER™ KINGPINLESS

310 & 410 SERIES

- NEW Precision Laser Cut Designs
- Industry Leading 3-Year Warranty
- 310 Now Featuring Thicker 3/8" Legs for Increased Strength
- Proudly Made in the USA
- Premium Quality and Performance
- Newly Designed Brakes and Toe Guards Coming Soon

View Product on
Pages 48 – 51

New Precision Laser Cut Design
Premium USA-made Quality

NEW

AlbionCasters.com

170

Heavy Duty Kingpinless Casters

CAPACITY TO 1500



One year standard warranty. Ideal for economical applications where kingpin casters will not simply hold up to shock or impact. Also see our 3 year warranty offering, the 110 Series (pages 42-44)

TYPICAL APPLICATIONS

- Dollies
- Dough troughs
- Platform trucks
- Tow line
- Utility carts
- Tooling fixtures
- Scrap metal carriers

MOUNTING OPTIONS Standard Plate

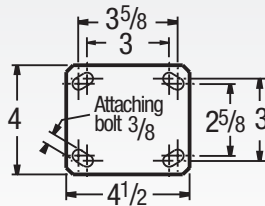

SWIVEL CROSS SECTION



+ For swivel models add "S", for rigid model add "R" to end of base caster number.

	Wheel Diameter (Inches)	Tread Width (Inches)	Capacity (Lbs) (Based on manual operation)	Overall Height (Inches)	Swivel Lead (Inches)	Base Caster Number+
Neoprene on Aluminum (28 Precision Ball Bearing)						
NP	5	2	600	6 1/2	1 3/8	170NP05228
	6	2	700	7 1/2	1 9/16	170NP06228
	8	2	700	9 1/2	2 1/4	170NP08228S-01

	Wheel Diameter (Inches)	Tread Width (Inches)	Capacity (Lbs) (Based on manual operation)	Overall Height (Inches)	Swivel Lead (Inches)	Base Caster Number+
Moldon Rubber on Cast Iron (01 Roller Bearing)						
MR	4	2	300	5 5/8	1 3/16	170MR04201
	5	2	450	6 1/2	1 3/8	170MR05201
	6	2	500	7 1/2	1 9/16	170MR06201
	8	2	600	9 1/2	2 1/4	170MR08201S-01

	Wheel Diameter (Inches)	Tread Width (Inches)	Capacity (Lbs) (Based on manual operation)	Overall Height (Inches)	Swivel Lead (Inches)	Base Caster Number+
X-tra Soft Round Tread (01 Roller Bearing)*						
XR	6	2	450	7 1/2	1 9/16	170XR06201
	8	2	600	9 1/2	2 1/4	170XR08201S-01

*Delrin (51) and Precision Ball (28) bearings available. Change "01" to other bearing code. Delrin example: 170XR06251.



Economical



Ergonomic



Towing^

FEATURES

- **Top Plate:** 5/16" AISI 1045 steel
- **Yoke Base:** Notched AISI 1045 steel
- **Swivel Section:** One row of 3/8" ball bearings are mounted in a precision machined 2-3/8" diameter raceway. Zerk in swivel section
- **Axle:** 1/2" diameter hollow axle with zerk fitting on roller and tapered bearing models (Solid axle on Delrin, precision ball, and Oilex models)
- **Finish:** Zinc plating
- Alternate or custom caster configurations available

BRAKE OPTIONS

To order, add brake code below to end of model. Example: 170XS06201SCB170

Cam specify **CB170**



Single Side specify **SSB110**. Double Sided specify **DSB110**

Face specify **FBB**



Face specify **FBE**

Face specify **FBC** (Not available with swivel lock)



Hand operated field installable swivel lock specify **L**

Foot operated field installable swivel lock order **SL160002** separately



BEARING OPTIONS



STAINLESS STEEL OPTION

See pages 80-81.



+ For swivel models add "S", for rigid model add "R" to end of base caster number.

	Wheel Diameter (Inches)	Tread Width (Inches)	Capacity (Lbs) (Based on manual operation)	Overall Height (Inches)	Swivel Lead (Inches)	Base Caster Number+
X-tra Soft Flat Tread (01 Roller Bearing)*						
XS	4	2	400	5 5/8	1 3/16	170XS04201
	5	2	500	6 1/2	1 3/8	170XS05201
	6	2	600	7 1/2	1 9/16	170XS06201
	8	2	675	9 1/2	2 1/4	170XS08201S-01

*All 170 bearings listed are available. Delrin example: 170XS05251.

	Wheel Diameter (Inches)	Tread Width (Inches)	Capacity (Lbs) (Based on manual operation)	Overall Height (Inches)	Swivel Lead (Inches)	Base Caster Number+
SZ Solid Monoprene (27 Radial Ball Bearing)						
SZ	6	2	250	7 1/2	1 9/16	170SZ06227
	8	2	280	9 1/2	2 1/4	170SZ08227S-01

For grey tread, specify "SV" and "28" (28 Prec. Ball Bearing) in part numbers (example: 16SV06228 or 16SV08228S-01)

	Wheel Diameter (Inches)	Tread Width (Inches)	Capacity (Lbs) (Based on manual operation)	Overall Height (Inches)	Swivel Lead (Inches)	Base Caster Number+
Aubin Industries Swivel-EAZ® Crown Tread (28 Prec. Ball Bearing)						
EY	4	2	675	5 5/8	1 3/16	170EY04228
	5	2	900	6 1/2	1 3/8	170EY05228
	6	2	1425	7 1/2	1 9/16	170EY06228
	8	2	1500	9 1/2	2 1/4	170EY08228S-01

Continue on next page >>

+ For swivel models add "S", for rigid model add "R" to end of base caster number.

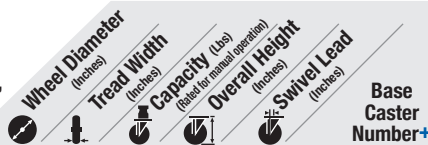

Aubin Industries Swivel-EAZ® Flat Tread (28 Prec. Ball Bearing)

Model	Wheel Diameter (Inches)	Tread Width (Inches)	Capacity (Lbs) (Based on nominal operation)	Overall Height (Inches)	Swivel Lead (Inches)	Base Caster Number+
EZ	4	2	900	5 5/8	1 3/16	170EZ04228
	5	2	1400	6 1/2	1 3/8	170EZ05228
	6	2	1500	7 1/2	1 9/16	170EZ06228
	8	2	1500	9 1/2	2 1/4	170EZ08228S-01

Polyurethane on Aluminum Round Tread (28 Precision Ball Bearing)

Model	Wheel Diameter (Inches)	Tread Width (Inches)	Capacity (Lbs) (Based on nominal operation)	Overall Height (Inches)	Swivel Lead (Inches)	Base Caster Number+
AX	4	2	700	5 5/8	1 3/16	170AX04228
	5	2	1000	6 1/2	1 3/8	170AX05228
	6	2	1250	7 1/2	1 9/16	170AX06228
	8	2	1500	9 1/2	2 1/4	170AX08228S-01

85 Shore A

Polyurethane on Aluminum Round Tread (28 Precision Ball Bearing)

Model	Wheel Diameter (Inches)	Tread Width (Inches)	Capacity (Lbs) (Based on nominal operation)	Overall Height (Inches)	Swivel Lead (Inches)	Base Caster Number+
PM	5	2	1000	6 1/2	1 3/8	170PM05228
	6	2	1250	7 1/2	1 9/16	170PM06228
	8	2	1500	9 1/2	2 1/4	170PM08228S-01

95 Shore A

Polyurethane on Aluminum Round Tread (28 Precision Ball Bearing)

Model	Wheel Diameter (Inches)	Tread Width (Inches)	Capacity (Lbs) (Based on nominal operation)	Overall Height (Inches)	Swivel Lead (Inches)	Base Caster Number+
PM 80A	5	2	1000	6 1/2	1 3/8	170PM0522880A
	6	2	1250	7 1/2	1 9/16	170PM0622880A
	8	2	1500	9 1/2	2 1/4	170PM0822880AS-01

80 Shore A To Specify Rigid or Swivel, insert "R" or "S" before "80A". Example: 170PM08228R80A.

Magnum Polyurethane on Aluminum Round Tread (28 Prec. Ball)

Model	Wheel Diameter (Inches)	Tread Width (Inches)	Capacity (Lbs) (Based on nominal operation)	Overall Height (Inches)	Swivel Lead (Inches)	Base Caster Number+
UA	4	2	700	5 5/8	1 3/16	170UA04228
	6	2	750	7 1/2	1 9/16	170UA06228
	8	2	900	9 1/2	2 1/4	170UA08228S-01

Blue Shore 95A Standard

UA Black Shore 70A
4"=400 capacity
6"=410 capacity
8"=500 capacity

UA Red Shore 80A
4"=500 capacity
6"=500 capacity
8"=800 capacity

UA Orange Shore 73D
4"=900 capacity
6"=1,000 capacity
8"=1,200 capacity

To order color/durometer enter durometer code at end of model. Red wheel example: 170UA08228S80A. To specify Rigid or Swivel, insert "R" or "S" before last 3 digit durometer code. Ex: 170UA08228R80A.

Polyurethane on Polypropylene (01 Roller Bearing)

Model	Wheel Diameter (Inches)	Tread Width (Inches)	Capacity (Lbs) (Based on nominal operation)	Overall Height (Inches)	Swivel Lead (Inches)	Base Caster Number+
XA	4	2	600	5 5/8	1 3/16	170XA04201
	5	2	750	6 1/2	1 3/8	170XA05201
	6	2	900	7 1/2	1 9/16	170XA06201
	8	2	1000	9 1/2	2 1/4	170XA08201S-01

Phenolic (01 Roller Bearing)

Model	Wheel Diameter (Inches)	Tread Width (Inches)	Capacity (Lbs) (Based on nominal operation)	Overall Height (Inches)	Swivel Lead (Inches)	Base Caster Number+
TM	4	2	800	5 5/8	1 3/16	170TM04201
	5	2	1000	6 1/2	1 3/8	170TM05201
	6	2	1200	7 1/2	1 9/16	170TM06201
	8	2	1400	9 1/2	2 1/4	170TM08201S-01

Polyurethane on Cast Iron (01 Roller Bearing)*

Model	Wheel Diameter (Inches)	Tread Width (Inches)	Capacity (Lbs) (Based on nominal operation)	Overall Height (Inches)	Swivel Lead (Inches)	Base Caster Number+
PY	4	2	750	5 5/8	1 3/16	170PY04201
	5	2	1050	6 1/2	1 3/8	170PY05201
	6	2	1200	7 1/2	1 9/16	170PY06201
	8	2	1500	9 1/2	2 1/4	170PY08201S-01

95 Shore A

*Available with Precision Ball (28) bearings (except 4" diameter models). Change 01 to other bearing code. Example: 170PY05228.

For grey tread specify "SV" wheel code (example 16SV05228).

+ For swivel models add "S", for rigid model add "R" to end of base caster number.

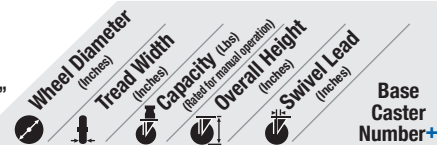

Polyurethane on Cast Iron (01 Roller Bearing)*

Model	Wheel Diameter (Inches)	Tread Width (Inches)	Capacity (Lbs) (Based on nominal operation)	Overall Height (Inches)	Swivel Lead (Inches)	Base Caster Number+
PY 80A	4	2	600	5 5/8	1 3/16	170PY0420180A
	5	2	840	6 1/2	1 3/8	170PY0520180A
	6	2	960	7 1/2	1 9/16	170PY0620180A
	8	2	1200	9 1/2	2 1/4	170PY0820180AS-01

*Available with Precision Ball (28) bearings (except 4" diameter models). Change 01 to other bearing code. To Specify Rigid or Swivel, insert "R" or "S" before "80A". Example: 170PY06228R80A.

Polyurethane on Heavy Duty Cast Iron (28 Precision Ball Bearing)

Model	Wheel Diameter (Inches)	Tread Width (Inches)	Capacity (Lbs) (Based on nominal operation)	Overall Height (Inches)	Swivel Lead (Inches)	Base Caster Number+
PF	6	2	1500	7 1/2	1 9/16	170PF06228
	8	2	1500	9 1/2	2 1/4	170PF08228S-01

95 Shore A

X-treme Plus Solid Polyurethane (01 Roller Bearing)*

Model	Wheel Diameter (Inches)	Tread Width (Inches)	Capacity (Lbs) (Based on nominal operation)	Overall Height (Inches)	Swivel Lead (Inches)	Base Caster Number+
XP	4	2	1400	5 5/8	1 3/16	170XP04201
	5	2	1200	6 1/2	1 3/8	170XP05201
	6	2	1400	7 1/2	1 9/16	170XP06201
	8	2	1200	9 1/2	2 1/4	170XP08201S-01

*All 170 bearings listed are available. Delrin example: 170XP05251.

Solid Elastomer (28 Precision Ball)*

Model	Wheel Diameter (Inches)	Tread Width (Inches)	Capacity (Lbs) (Based on nominal operation)	Overall Height (Inches)	Swivel Lead (Inches)	Base Caster Number+
SE	4	2	1000	5 5/8	1 3/16	170SE04228
	5	2	1000	6 1/2	1 3/8	170SE05228
	6	2	1200	7 1/2	1 9/16	170SE06228
	8	2	1200	9 1/2	2 1/4	170SE08228S-01

*Straight Roller (01) and Delrin (51) bearings available. Change "01" to other bearing code. Delrin example: 170SE06251.

Glass Filled Polypropylene (01 Roller Bearing)*

Model	Wheel Diameter (Inches)	Tread Width (Inches)	Capacity (Lbs) (Based on nominal operation)	Overall Height (Inches)	Swivel Lead (Inches)	Base Caster Number+
RT	4	2	800	5 5/8	1 3/16	170RT04201
	5	2	1000	6 1/2	1 3/8	170RT05201
	6	2	1200	7 1/2	1 9/16	170RT06201
	8	2	1400	9 1/2	2 1/4	170RT08201S-01

*Plain Bore (41), Precision ball (28) and Pedestal Precision Ball (29) bearings available. Change "01" to other bearing code. Plain Bore example: 170RT04241.

Heavy Duty Glass Filled Nylon (01 Roller Bearing)*

Model	Wheel Diameter (Inches)	Tread Width (Inches)	Capacity (Lbs) (Based on nominal operation)	Overall Height (Inches)	Swivel Lead (Inches)	Base Caster Number+
DT	4	2	1000	5 5/8	1 3/16	170DT04201
	5	2	1200	6 1/2	1 3/8	170DT05201
	6	2	1400	7 1/2	1 9/16	170DT06201
	8	2	1500	9 1/2	2 1/4	170DT08201S-01

*Plain Bore (41), Precision Ball (28) and Pedestal Precision Ball (29) bearings available. Change "01" to other bearing code. Precision Ball example: 170DT04228.

High Temp Glass Filled Nylon (01 Roller Bearing)*

Model	Wheel Diameter (Inches)	Tread Width (Inches)	Capacity (Lbs) (Based on nominal operation)	Overall Height (Inches)	Swivel Lead (Inches)	Base Caster Number+
HT	4	2	800	5 5/8	1 3/16	170HT04201
	5	2	1000	6 1/2	1 3/8	170HT05201
	6	2	1200	7 1/2	1 9/16	170HT06201
	8	2	1400	9 1/2	2 1/4	170HT08201S-01

*Plain Bore (41) available. Change "01" to other bearing code. Example: 110HT04241.

Cast Iron (01 Roller Bearing)

Model	Wheel Diameter (Inches)	Tread Width (Inches)	Capacity (Lbs) (Based on nominal operation)	Overall Height (Inches)	Swivel Lead (Inches)	Base Caster Number+
CA	4	2	1000	5 5/8	1 3/16	170CA04201
	5	2	1300	6 1/2	1 3/8	170CA05201
	6	2	1400	7 1/2	1 9/16	170CA06201
	8	2	1500	9 1/2	2 1/4	170CA08201S-01

Heavy Duty Cast Iron (01 Roller Bearing)

Model	Wheel Diameter (Inches)	Tread Width (Inches)	Capacity (Lbs) (Based on nominal operation)	Overall Height (Inches)	Swivel Lead (Inches)	Base Caster Number+
CH	5	2	1500	6 1/2	1 3/8	170CH05201
	6	2	1500	7 1/2	1 9/16	170CH06201
	8	2	1500	9 1/2	2 1/4	170CH08201S-01

170 SERIES • CAPACITY TO 1500

HEAVY DUTY KINGPINLESS

310

Made in the USA
Contender™
Kingpinless Casters
CAPACITY TO 4100



Constructed from high quality, heat treated AISI 1045 laser-cut steel. Precision machined raceway, fully welded legs (inside and outside), and kingpinless design delivers superior strength in rugged applications.

TYPICAL APPLICATIONS

- Conveyor-drawn tow-trucks
- Heavy duty bakery racks
- Production dollies
- Heavy duty dough troughs

SWIVEL CROSS SECTION

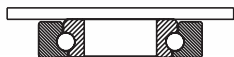

MOUNTING OPTIONS Standard Plate

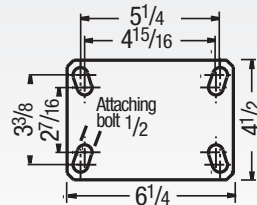

Special Order Plate

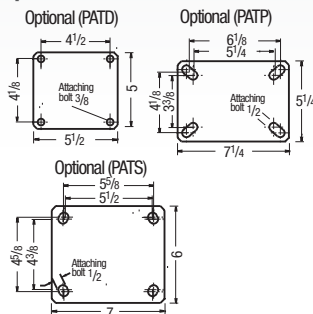

Premium Quality



Towing[^]



Environmentally Friendly

FEATURES

- **New laser cut steel construction**
- **3 Year warranty**
- **Top Plate:** 5/16" AISI 1045 heat treated steel welded inside and out for longer life
- **Swivel Section:** One row of 1/2" ball bearings mounted in a heat treated precision machined raceway. Zerk in swivel section
- **Yoke Base:** Notched AISI 1045 steel
- **Legs:** 3/8" thick welded inside and out
- **Axle:** 3/4" diameter
- **Finish:** RoHS Zinc plating, for greater corrosion resistance than paint
- Alternate or custom caster configurations available

RIG OPTIONS

- **Optional Towable Swivel Leads:**
 6" dia. 2-7/32"
 8" dia. 2-15/16"
 10" dia. 3-3/8"
 12" dia. 4-5/16"
 Consult factory for capacity changes. To order add **XL** to end of model. Example: 310MR06401**SXL**
- **Optional Spring Loaded:** Greater capacity and better shock protection. Noise levels are reduced through the dampening effect of these casters. See pages 94-95



BRAKE OPTIONS

To order, add brake code below to end of model. Example: 310PY08401**SP**

Poly Cam
specify **P**



PLB Integrated
specify **PLB**

Single Side specify **SSB310**
Double Sided specify **DSB310**



Face Contact
specify **FBB**

Hand Operated Swivel Lock
specify **L**



BEARING OPTIONS

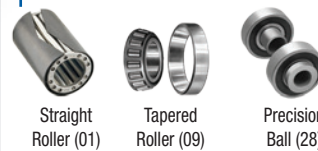

TOE GUARD



Specify **TOE** for caster integrated toe guard. Standard

model toe guards are 1/2" from the floor.

STAINLESS STEEL OPTION

See page 84



	Wheel Diameter (Inches)	Tread Width (Inches)	Capacity (Lbs) (Rate for manual operation)	Overall Height (Inches)	Swivel Lead (Inches)	Base Caster Number+
--	-------------------------	----------------------	--	-------------------------	----------------------	---------------------

Moldon Rubber on Cast Iron (01 Roller Bearing)*						
MR/MH	6	2 1/2	700	7 1/2	1 3/8	310MR06401
	6	3	750	7 1/2	1 3/8	310MR06501
	8	2 1/2	850	10 1/8	2 1/16	310MR08401
	8	3	900	10 1/8	2 1/16	310MR08501
	10	2 1/2	950	11 1/2	2 1/4	310MR10401
	10	2 1/2**	1500	11 1/2	2 1/4	310MH10401
	10	3	1000	11 1/2	2 1/4	310MR10501
	10	3**	1800	11 1/2	2 1/4	310MH10501
	12	2 1/2	950	13 1/2	2 11/16	310MR12401
	12	2 1/2**	1700	13 1/2	2 11/16	310MH12401
	12	3	1200	13 1/2	2 11/16	310MR12501

*MR available with Tapered Roller (09) bearings. Change "01" to "09". Example: 310MR10409.

**Heavy-duty MH version of wheel.

Polyurethane on Cast Iron (01 Roller Bearing)*

PY	6	2 1/2	1600	7 1/2	1 3/8	310PY06401
	6	3	2000	7 1/2	1 3/8	310PY06501
	8	2 1/2	2000	10 1/8	2 1/16	310PY08401
	8	3	2500	10 1/8	2 1/16	310PY08501
	10	2 1/2	2300	11 1/2	2 1/4	310PY10401
	10	3	3000	11 1/2	2 1/4	310PY10501
	12	2 1/2	2700	13 1/2	2 11/16	310PY12401
	12	3	3500	13 1/2	2 11/16	310PY12501

*Tapered Roller (09) bearings available. Change "01" to "09". Example: 310PY10409.

80A Durometer available, add "80A" to end of caster number. 80A capacity reduced by approximately 20%. Swivel example: 310PY06401**S80A**.

+ For swivel models add "S", for rigid model add "R" to end of base caster number.

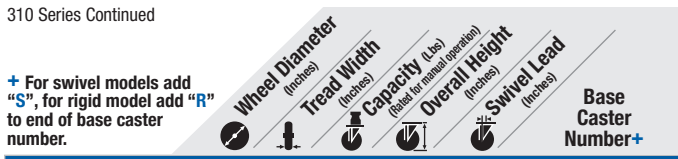

PD	Wheel Diameter (Inches)	Tread Width (Inches)	Capacity (Lbs) (Rated for manual operation)	Overall Height (Inches)	Swivel Lead (Inches)	Base Caster Number+
	8	2 1/2	2010	10 1/8	2 1/16	310PD08401
	8	3	2520	10 1/8	2 1/16	310PD08501
	10	2 1/2	2370	11 1/2	2 1/4	310PD10401
	10	3	3000	11 1/2	2 1/4	310PD10501

Standard durometer 95 Shore A. Other durometers available.
 *Tapered Roller (09) bearings available. Change "01" to "09". Example: 310PD10409.

PX	Wheel Diameter (Inches)	Tread Width (Inches)	Capacity (Lbs) (Rated for manual operation)	Overall Height (Inches)	Swivel Lead (Inches)	Base Caster Number+
	6	3	2250	7 1/2	1 3/8	310PX06501
	8	3	2780	10 1/8	2 1/16	310PX08501
	10	2 1/2	2600	11 1/2	2 1/4	310PX10401
	10	3	3300	11 1/2	2 1/4	310PX10501
	12	3	3760	13 1/2	2 11/16	310PX12501

Standard durometer 95 Shore A. Other durometers available.
 *Tapered Roller (09) bearings available. Change "01" to "09". Example: 310PX10409.

EY	Wheel Diameter (Inches)	Tread Width (Inches)	Capacity (Lbs) (Rated for manual operation)	Overall Height (Inches)	Swivel Lead (Inches)	Base Caster Number+
	6	3	2137	7 1/2	1 3/8	310EY06528
	8	3	3250	10 1/8	2 1/16	310EY08528
	10	3	3800	11 1/2	2 1/4	310EY10528
	12	3	4000	13 1/2	2 11/16	310EY12528

EZ	Wheel Diameter (Inches)	Tread Width (Inches)	Capacity (Lbs) (Rated for manual operation)	Overall Height (Inches)	Swivel Lead (Inches)	Base Caster Number+
	6	3	2850	7 1/2	1 3/8	310EZ06528
	8	3	4000	10 1/8	2 1/16	310EZ08528
	10	3	4100	11 1/2	2 1/4	310EZ10528
	12	3	4100	13 1/2	2 11/16	310EZ12528

PI	Wheel Diameter (Inches)	Tread Width (Inches)	Capacity (Lbs) (Rated for manual operation)	Overall Height (Inches)	Swivel Lead (Inches)	Base Caster Number+
	6	2 1/2	1600	7 1/2	1 3/8	310PI06401
	6	3	2000	7 1/2	1 3/8	310PI06501
	8	2 1/2	2000	10 1/8	2 1/16	310PI08401
	8	3	2500	10 1/8	2 1/16	310PI08501
	10	2 1/2	2200	11 1/2	2 1/4	310PI10401
	10	3	2800	11 1/2	2 1/4	310PI10501
	12	2 1/2	2500	13 1/2	2 11/16	310PI12401
	12	3	3000	13 1/2	2 11/16	310PI12501

PF	Wheel Diameter (Inches)	Tread Width (Inches)	Capacity (Lbs) (Rated for manual operation)	Overall Height (Inches)	Swivel Lead (Inches)	Base Caster Number+
	6	2 1/2	2900	7 1/2	1 3/8	310PF06428
	8	2 1/2	3100	10 1/8	2 1/16	310PF08428
	8	3	4000	10 1/8	2 1/16	310PF08528
	10	3	4100	11 1/2	2 1/4	310PF10528

95 Shore A
 *Tapered Roller (09) bearings available. Change "28" to "09". Example: 310PF10509.

PR	Wheel Diameter (Inches)	Tread Width (Inches)	Capacity (Lbs) (Rated for manual operation)	Overall Height (Inches)	Swivel Lead (Inches)	Base Caster Number+
	10	3	2400	11 1/2	2 1/4	310PR10528
	12	3	2800	13 1/2	2 11/16	310PR12528

80 Shore A
 *Tapered Roller (09) bearings available. Change "28" to "09". Example: 310PR10509.

VY	Wheel Diameter (Inches)	Tread Width (Inches)	Capacity (Lbs) (Rated for manual operation)	Overall Height (Inches)	Swivel Lead (Inches)	Base Caster Number+
	6	2 1/2	2350	7 1/2	1 3/8	310VY06401
	6	3	3000	7 1/2	1 3/8	310VY06501
	8	2 1/2	2900	10 1/8	2 1/16	310VY08401
	8	3	4000	10 1/8	2 1/16	310VY08501
	10	3	4100	11 1/2	2 1/4	310VY10501

*Tapered Roller (09) bearings available. Change "01" to "09". Example: 310VY10509.

VX	Wheel Diameter (Inches)	Tread Width (Inches)	Capacity (Lbs) (Rated for manual operation)	Overall Height (Inches)	Swivel Lead (Inches)	Base Caster Number+
	6	3	3000	7 1/2	1 3/8	310VX06501
	8	3	4000	10 1/8	2 1/16	310VX08501
	10	3	4100	11 1/2	2 1/4	310VX10501

*Tapered Roller (09) bearings available. Change "01" to "09". Example: 310VX10509.

+ For swivel models add "S", for rigid model add "R" to end of base caster number.

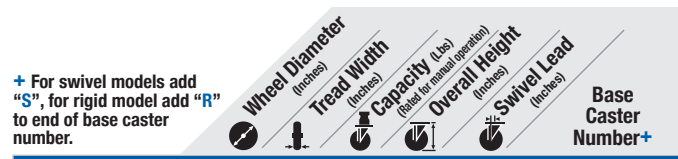

XP	Wheel Diameter (Inches)	Tread Width (Inches)	Capacity (Lbs) (Rated for manual operation)	Overall Height (Inches)	Swivel Lead (Inches)	Base Caster Number+
	8	2 1/2	2000	10 1/8	2 1/16	310XP08428
	8	3	2000	10 1/8	2 1/16	310XP08528
	10	2 1/2	2500	11 1/2	2 1/4	310XP10428
	10	3	2500	11 1/2	2 1/4	310XP10528

TM	Wheel Diameter (Inches)	Tread Width (Inches)	Capacity (Lbs) (Rated for manual operation)	Overall Height (Inches)	Swivel Lead (Inches)	Base Caster Number+
	6	2 1/2	1600	7 1/2	1 3/8	310TM06401
	6	3	2000	7 1/2	1 3/8	310TM06501
	8	2 1/2	2000	10 1/8	2 1/16	310TM08401
	8	3	2500	10 1/8	2 1/16	310TM08501
	10	2 1/2	2500	11 1/2	2 1/4	310TM10401
	10	3	2900	11 1/2	2 1/4	310TM10501
	12	2 1/2	3000	13 1/2	2 11/16	310TM12401
	12	3	3500	13 1/2	2 11/16	310TM12501

*Tapered Roller (09) bearings available. Change "01" to "09". Example: 310TM10409.

NX	Wheel Diameter (Inches)	Tread Width (Inches)	Capacity (Lbs) (Rated for manual operation)	Overall Height (Inches)	Swivel Lead (Inches)	Base Caster Number+
	6	2 1/2	4100	7 1/2	1 3/8	310NX06428
	6	3	4100	7 1/2	1 3/8	310NX06528
	8	2 1/2	4100	10 1/8	2 1/16	310NX08428
	8	3	4100	10 1/8	2 1/16	310NX08528
	10	2 1/2	4100	11 1/2	2 1/4	310NX10428
	10	3	4100	11 1/2	2 1/4	310NX10528

CA	Wheel Diameter (Inches)	Tread Width (Inches)	Capacity (Lbs) (Rated for manual operation)	Overall Height (Inches)	Swivel Lead (Inches)	Base Caster Number+
	6	2 1/2	2300	7 1/2	1 3/8	310CA06401
	6	3	2800	7 1/2	1 3/8	310CA06501
	8	2 1/2	2300	10 1/8	2 1/16	310CA08401
	8	3	2800	10 1/8	2 1/16	310CA08501
	10	2 1/2	2300	11 1/2	2 1/4	310CA10401
	10	3	2800	11 1/2	2 1/4	310CA10501
	12	3	2800	13 1/2	2 11/16	310CA12501

*Tapered Roller (09) bearings available. Change "01" to "09". Example: 310CA10409.

VG/VF	Wheel Diameter (Inches)	Tread Width (Inches)	Capacity (Lbs) (Rated for manual operation)	Overall Height (Inches)	Swivel Lead (Inches)	Base Caster Number+
	6	2 1/2	2500	7 1/2	1 3/8	310VG06401
	8	2 1/2	2500	10 1/8	2 1/16	310VG08401
	8	3	2500	10 1/8	2 1/16	310VG08501
	10	3	3500	11 1/2	2 1/4	310VG10501

V-Groove Drop Forged Steel (01 Roller Bearing)
 8 | 3 | 4100 | 10 1/8 | 2 1/16 | 310VF08501
 *Tapered Roller (09) bearings available. Change "01" to "09". Example: 310VF10409.

FS	Wheel Diameter (Inches)	Tread Width (Inches)	Capacity (Lbs) (Rated for manual operation)	Overall Height (Inches)	Swivel Lead (Inches)	Base Caster Number+
	6	2 1/2	4000	7 1/2	1 3/8	310FS06401
	8	2 1/2	4000	10 1/8	2 1/16	310FS08401
	8	3	4100	10 1/8	2 1/16	310FS08501
	10	3	4100	11 1/2	2 1/4	310FS10501

*Tapered Roller (09) bearings available. Change "01" to "09". Example: 310FS10509.

FR, FM, VM	Wheel Diameter (Inches)	Tread Width (Inches)	Capacity (Lbs) (Rated for manual operation)	Overall Height (Inches)	Swivel Lead (Inches)	Base Caster Number+
	6	2 1/2	3500	7 1/2	1 3/8	310FR06401
	6	3	4100	7 1/2	1 3/8	310FR06501
	8	3	4100	10 1/8	2 1/16	310FR08501
	10	3	4100	11 1/2	2 1/4	310FR10501

*Tapered Roller (09) bearings available. Change "01" to other bearing code. Example: 310FR08509.
 Ductile Iron Flat Tread (FM) and V-Groove (VM) models available. Change FR wheel code to FM or VM. Example: 310FM08501.

310 SERIES • CAPACITY TO 4100

HEAVY DUTY KINGPINLESS

410

Made in the USA
Contender™
Kingpinless Casters
CAPACITY TO 5400



Constructed from high quality, heat treated AISI 1045 laser-cut steel. Precision machined race-way, fully welded legs (inside and outside), and kingpinless design delivers superior strength in rugged applications.

TYPICAL APPLICATIONS

- Conveyor-drawn tow-trucks
- Heavy duty bakery racks
- Production dollies
- Heavy duty dough troughs

SWIVEL CROSS SECTION



MOUNTING OPTIONS Standard Plate

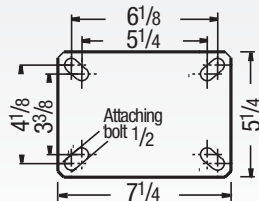

Special Order Plate

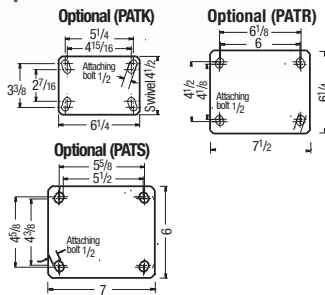

Premium Quality



Towing[^]



Environmentally Friendly

FEATURES

- New laser-cut steel construction
- 3 Year warranty
- Top Plate: 3/8" AISI 1045 heat treated steel welded inside and out for longer life
- Swivel Section: One row of 1/2" ball bearings mounted in a heat treated precision machined race-way. Zerk in swivel section
- Yoke Base: Notched AISI 1045 steel
- Legs: 3/8" thick welded inside and out
- Axle: 3/4" diameter
- Finish: RoHS Zinc plating, for greater corrosion resistance than paint
- Alternate or custom caster configurations available

RIG OPTIONS

- **Optional Spring Loaded:** Greater capacity and better shock protection. Noise levels are reduced through the dampening effect of these casters. See pages 96-97.



BRAKE OPTIONS

To order, add brake code below to end of model. Example: 410PY08401SP

Poly Cam
specify **P**



PLB Integrated
specify **PLB**



Single Side specify **SSB410**. **Double Sided** specify **DSB410**



Face Contact
specify **FBB**

Hand Operated Swivel Lock
specify **L**



BEARING OPTIONS

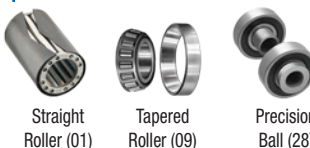

TOE GUARD



Specify **TOE** for caster integrated toe guard. Standard

model toe guards are 1/2" from the floor.

+ For swivel models add "S", for rigid model add "R" to end of base caster number.

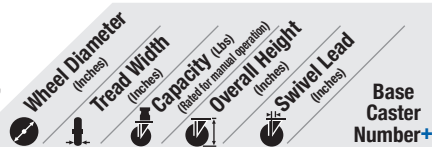

Polyurethane on Aluminum (01 Roller Bearing)*

PD	6	8	10	12	15	20
8	2 1/2	2010	10 1/2	2 15/16	410PD08401	
8	3	2520	10 1/2	2 15/16	410PD08501	
10	2 1/2	2370	12 1/2	3 3/8	410PD10401	
10	3	3000	12 1/2	3 3/8	410PD10501	

*Tapered Roller (09) bearings and Precision Bearing (28) available. Change "01" to other bearing code. Tapered example: 410PD08409.

Polyurethane on Cast Iron (01 Roller Bearing)*

PY	6	8	10	12	15	20
6	2 1/2	1600	8	27/32	410PY06401	
6	3	2000	8	27/32	410PY06501	
8	2 1/2	2000	10 1/2	2 15/16	410PY08401	
8	3	2500	10 1/2	2 15/16	410PY08501	
10	2 1/2	2300	12 1/2	3 3/8	410PY10401	
10	3	3000	12 1/2	3 3/8	410PY10501	
12	2 1/2	2700	15 1/2	4 5/16	410PY12401	
12	3	3500	15 1/2	4 5/16	410PY12501	

*Tapered Roller (09) bearings available. Change "01" to "09". Example: 410PY10509.

80A Durometer available, add "80A" to end of caster number. 80A capacity reduced by approximately 20%. Swivel example: 410PY08401S80A.

Aubin Industries Swivel-EAZ® Round Tread (28 Prec. Ball Bearing)

EY	6	8	10	12	15	20
6	3	2137	8	27/32	410EY06528	
8	3	3250	10 1/2	2 15/16	410EY08528	
10	3	3800	12 1/2	3 3/8	410EY10528	
12	3	4000	15 1/2	4 5/16	410EY12528	

+ For swivel models add "S", for rigid model add "R" to end of base caster number.

Molder Rubber on Cast Iron (01 Roller Bearing)*

MR/MH	6	8	10	12	15	20
6	2 1/2	700	8	27/32	410MR06401	
6	3	750	8	27/32	410MR06501	
8	2 1/2	850	10 1/2	2 15/16	410MR08401	
8	2 1/2**	1300	10 1/2	2 15/16	410MH08401	
8	3	900	10 1/2	2 15/16	410MR08501	
10	2 1/2	950	12 1/2	3 3/8	410MR10401	
10	2 1/2**	1500	12 1/2	3 3/8	410MH10401	
10	3	1000	12 1/2	3 3/8	410MR10501	
10	3**	1800	12 1/2	3 3/8	410MH10501	
12	2 1/2	950	15 1/2	4 5/16	410MR12401	
12	2 1/2**	1700	15 1/2	4 5/16	410MH12401	
12	3	1200	15 1/2	4 5/16	410MR12501	

*MR available with Tapered Roller (09) bearings. Change "01" to "09". Example: 410MR10409.

**Heavy-duty MH version of wheel.

+ For swivel models add "S", for rigid model add "R" to end of base caster number.

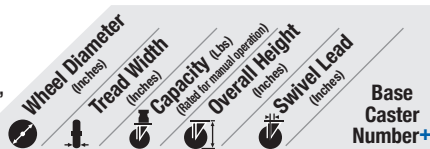

Aubin Industries Swivel-EAZ® Flat Tread (28 Prec. Ball Bearing)							
EZ		6	3	2850	8	27/32	410EZ06528
		8	3	4000	10 1/2	215/16	410EZ08528
		10	3	4800	12 1/2	3 3/8	410EZ10528
		12	3	5400	15 1/2	4 5/16	410EZ12528

Thick Tread Polyurethane (01 Roller Bearing)*							
PX		6	3	2250	8	27/32	410PX06501
		8	3	2780	10 1/2	215/16	410PX08501
		10	2 1/2	2600	12 1/2	3 3/8	410PX10401
		10	3	3300	12 1/2	3 3/8	410PX10501
		12	3	3760	15 1/2	4 5/16	410PX12501

*Tapered Roller (09) bearings available. Change "01" to "09". Example: 410PX10509.

Polyurethane on Cast Iron (01 Roller Bearing)							
PI		6	2 1/2	1600	8	27/32	410PI06401
		6	3	2000	8	27/32	410PI06501
		8	2 1/2	2000	10 1/2	215/16	410PI08401
		8	3	2500	10 1/2	215/16	410PI08501
		10	2 1/2	2200	12 1/2	3 3/8	410PI10401
		10	3	2800	12 1/2	3 3/8	410PI10501
		12	2 1/2	2500	15 1/2	4 5/16	410PI12401
		12	3	3000	15 1/2	4 5/16	410PI12501

Polyurethane on Heavy Duty Cast Iron (28 Precision Ball Bearing)*							
PF		6	2 1/2	2900	8	27/32	410PF06428
		8	2 1/2	3100	10 1/2	215/16	410PF08428
		8	3	4000	10 1/2	215/16	410PF08528
		10	3	4200	12 1/2	3 3/8	410PF10528
		95 Shore A					

*Tapered Roller (09) bearings available. Change "28" to "09". Example: 410PF10509.

Polyurethane Reactive on Iron (28 Precision Ball Bearing)*							
PR		10	3	2400	12 1/2	215/16	410PR10528
		12	3	2800	15 1/2	3 3/8	410PR12528
		80 Shore A					

*Tapered Roller (09) bearings available. Change "28" to "09". Example: 410PR10509.

Vulkollan on Cast Iron (01 Roller Bearing)*							
VY		6	2 1/2	2350	8	27/32	410VY06401
		6	3	3000	8	27/32	410VY06501
		8	2 1/2	2900	10 1/2	215/16	410VY08401
		8	3	4000	10 1/2	215/16	410VY08501
		10	3	5000	12 1/2	3 3/8	410VY10501

*Tapered Roller (09) bearings available. Change "01" to "09". Example: 410VY10509.

Vulkollan Thick Tread Polyurethane (01 Roller Bearing)*							
VX		6	3	3000	8	27/32	410VX06501
		8	3	4000	10 1/2	215/16	410VX08501
		10	3	5000	12 1/2	3 3/8	410VX10501

*Tapered Roller (09) bearings available. Change "01" to "09". Example: 410VX10509.

X-treme Plus Solid Polyurethane (28 Precision Ball Bearing)							
XP		8	2 1/2	2000	10 1/2	215/16	410XP08428
		8	3	2000	10 1/2	215/16	410XP08528
		10	2 1/2	2500	12 1/2	3 3/8	410XP10428
		10	3	2500	12 1/2	3 3/8	410XP10528

+ For swivel models add "S", for rigid model add "R" to end of base caster number.

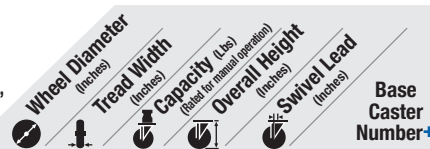

Phenolic (01 Roller Bearing)*							
TM		6	2 1/2	1600	8	27/32	410TM06401
		6	3	2000	8	27/32	410TM06501
		8	2 1/2	2000	10 1/2	215/16	410TM08401
		8	3	2500	10 1/2	215/16	410TM08501
		10	2 1/2	2500	12 1/2	3 3/8	410TM10401
		10	3	2900	12 1/2	3 3/8	410TM10501
		12	2 1/2	3000	15 1/2	4 5/16	410TM12401
		12	3	3500	15 1/2	4 5/16	410TM12501

*Tapered Roller (09) bearings available. Change "01" to "09". Example: 410TM10409.

Trionix™ High Impact Polymer (28 Precision Ball Bearing)							
NX		6	2 1/2	5400	8	27/32	410NX06428
		6	3	5400	8	27/32	410NX06528
		8	2 1/2	5400	10 1/2	215/16	410NX08428
		8	3	5400	10 1/2	215/16	410NX08528
		10	2 1/2	5400	12 1/2	3 3/8	410NX10428
		10	3	5400	12 1/2	3 3/8	410NX10528

Cast Iron (01 Roller Bearing)*							
CA		6	2 1/2	2300	8	27/32	410CA06401
		6	3	2800	8	27/32	410CA06501
		8	2 1/2	2300	10 1/2	215/16	410CA08401
		8	3	2800	10 1/2	215/16	410CA08501
		10	2 1/2	2300	12 1/2	3 3/8	410CA10401
		10	3	2800	12 1/2	3 3/8	410CA10501
		12	3	2800	15 1/2	4 5/16	410CA12501

*Tapered Roller (09) bearings available. Change "01" to "09". Example: 410CA10509.

V-Grooved Cast Iron (01 Roller Bearing)*							
VG		6	2 1/2	2500	8	27/32	410VG06401
		8	2 1/2	2500	10 1/2	215/16	410VG08401
		8	3	2500	10 1/2	215/16	410VG08501
		10	3	3500	12 1/2	3 3/8	410VG10501

*Tapered Roller (09) bearings available. Change "01" to "09". Example: 410VG10509.

Drop Forged V-Grooved Cast Iron (01 Roller Bearing)							
VF		8	3	5400	10 1/2	215/16	410VF08501

Drop Forged Steel (01 Roller Bearing)*							
FS		6	2 1/2	4000	8	27/32	410FS06401
		8	2 1/2	4000	10 1/2	215/16	410FS08401
		8	3	4500	10 1/2	215/16	410FS08501
		10	3	5400	12 1/2	3 3/8	410FS10501
		*Tapered Roller (09) bearings available. Change "01" to "09". Example: 410FS10509. 6x2-1/2 capacity increases to 5000, 8x3 capacity increases to 5400 and 10x3 capacity increases to 5400 with use of 09 bearing.					

Ductile Iron Crowned Tread (01 Roller Bearing)*							
FR		6	2 1/2	3500	8	27/32	410FR06401
		6	3	5400	8	27/32	410FR06501
		8	3	5400	10 1/2	215/16	410FR08501
		10	3	5400	12 1/2	3 3/8	410FR10501

*Tapered Roller (09) available. Change "01" to other bearing code. Example: 410FR06409. Ductile Iron Flat Tread (FM) and V-Groove (VM) models available. Change FR wheel code to FM or VM. Example: 410FM06401.

410 SERIES • CAPACITY TO 5400 HEAVY DUTY KINGPINLESS

610

Contender™ Kingpinless Casters CAPACITY TO 9500



Highly recommended for automotive and aerospace applications. This caster is built to take the punishment of constant swiveling or for service where shock or impact loads might damage less rugged casters.

TYPICAL APPLICATIONS

- Body dolly carts
- Engine dollies
- Material carts
- Chassis rack carts
- Paint line dollies
- Towed trash gondolas

SWIVEL CROSS SECTION

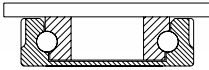

MOUNTING OPTION

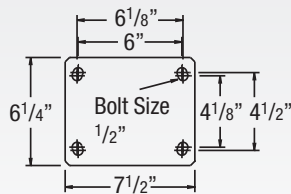

Premium Quality



Towing[^]



Environmentally Friendly

FEATURES

- **Top Plate:** 1/2" thick AISI 1045 steel precision machined and through-hardened for long life
- **Swivel Section:** 3/4" ball bearings mounted in a 4-3/8" precision machined raceway. Zerkl in swivel section
- **Legs:** 3/8" thick steel welded to yoke base using 100,000 psi weld filler
- **Axle:** 2-1/2" and 3" tread width wheels feature a 3/4" axle, 3-1/2" and 4" tread width wheels feature a 1" axle
- Alternate or custom caster configurations available

RIG OPTIONS

- Dual wheel models available, consult factory
- Shear disk mounting, consult factory
- **Optional Spring Loaded:** Greater capacity and better shock protection. Noise levels are reduced through the dampening effect of these casters. See pages 98-99.



BRAKE OPTIONS

To order, add brake code below to end of model. Example: 610PY08409SP

Poly Cam
specify **P**



PLB Integrated
specify **PLB**



Single Side specify **SSB610**. **Double Sided** specify **DSB610**



Hand Operated Swivel Lock
specify **L**

BEARING OPTIONS



Straight Roller (01)



Tapered Roller (09)



Precision Ball (28)

+ For swivel models add "S", for rigid model add "R" to end of base caster number.

Wheel Diameter (Inches)	Tread Width (Inches)	Capacity (Lbs) (Based on manual operation)	Overall Height (Inches)	Swivel Lead (Inches)	Base Caster Number+
-------------------------	----------------------	--	-------------------------	----------------------	---------------------

Moldon Rubber on Cast Iron (01 Roller Bearing)*

MR/MH	Wheel Diameter (Inches)	Tread Width (Inches)	Capacity (Lbs)	Overall Height (Inches)	Swivel Lead (Inches)	Base Caster Number
	6	2 1/2	540	8 1/2	1 3/4	610MR06401
	6	3	680	8 1/2	1 3/4	610MR06501
	8	2 1/2	670	10 1/2	2 1/4	610MR08401
	8	2 1/2**	1300	10 1/2	2 1/4	610MH08401
	8	3	840	10 1/2	2 1/4	610MR08501
	10	2 1/2**	1500	12 1/2	2 3/4	610MH10501
	10	3	1000	12 1/2	2 3/4	610MR10501
	10	3**	1800	12 1/2	2 3/4	610MH10501
	10	4	1400	12 1/2	2 3/4	610MR10701
	12	2 1/2**	1700	15 1/2	3 5/8	610MH12501
	12	3 1/2	1370	15 1/2	3 5/8	610MR12601
	12	4	1600	15 1/2	3 5/8	610MR12701
	14	3	1280	18	4 3/8	610MR14501

*MR available with Tapered Roller (01) bearings. Change "01" to "09". Example: 610MR10509.

**Heavy-duty MH version of wheel.

+ For swivel models add "S", for rigid model add "R" to end of base caster number.

Wheel Diameter (Inches)	Tread Width (Inches)	Capacity (Lbs) (Based on manual operation)	Overall Height (Inches)	Swivel Lead (Inches)	Base Caster Number+
-------------------------	----------------------	--	-------------------------	----------------------	---------------------

Polyurethane on Aluminum (01 Roller Bearing)

PD	Wheel Diameter (Inches)	Tread Width (Inches)	Capacity (Lbs)	Overall Height (Inches)	Swivel Lead (Inches)	Base Caster Number
	8	2 1/2	2010	10 1/2	2 1/4	610PD08401
	8	3	2520	10 1/2	2 1/4	610PD08501
	10	2 1/2	2370	12 1/2	2 3/4	610PD10401
	10	3	3000	12 1/2	2 3/4	610PD10501

Polyurethane on Cast Iron (09 Tapered Roller Bearing)

PY	Wheel Diameter (Inches)	Tread Width (Inches)	Capacity (Lbs)	Overall Height (Inches)	Swivel Lead (Inches)	Base Caster Number
	6	2 1/2	1600	8 1/2	1 3/4	610PY06409
	6	3	2000	8 1/2	1 3/4	610PY06509
	8	2 1/2	2000	10 1/2	2 1/4	610PY08409
	8	3	2500	10 1/2	2 1/4	610PY08509
	8	4	3800	10 1/2	2 1/4	610PY08709
	10	3	3000	12 1/2	2 3/4	610PY10509
	10	4	4200	12 1/2	2 3/4	610PY10709
	12	3 1/2	4110	15 1/2	3 5/8	610PY12609
	12	4	4800	15 1/2	3 5/8	610PY12709
	14	4	5000	18	4 3/8	610PY14709

*Roller (01) bearings available. Change "09" to "01". Example: 610PY10501.



80A Durometer available, add "80A" to end of caster number. 80A capacity reduced by approximately 20%. Swivel example: 610PY06409S80A.

Continue on next page >>

+ For swivel models add "S", for rigid model add "R" to end of base caster number.

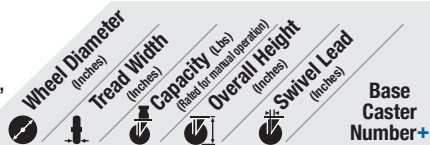

Aubin Industries Swivel-EAZ® Round Tread (28 Prec. Ball Bearing)							
EY		6	3	2137	8	27/32	610EY06528
		8	3	3250	10 1/2	2 15/16	610EY08528

Aubin Industries Swivel-EAZ® Flat Tread (28 Prec. Ball Bearing)							
EZ		6	3	2850	8	27/32	610EZ06528
		8	3	4000	10 1/2	2 15/16	610EZ08528
		10	3	4800	12 1/2	3 3/8	610EZ10528

Thick Tread Polyurethane (09 Tapered Roller Bearing)*							
PX		6	3	2250	8 1/2	1 3/4	610PX06509
		8	3	2780	10 1/2	1 3/4	610PX08509
		8	4	3850	10 1/2	2 1/4	610PX08709
		10	3	3300	12 1/2	2 3/4	610PX10509
		10	4	4620	12 1/2	2 3/4	610PX10709
		12	4	5280	15 1/2	3 5/8	610PX12709

*Roller (01) bearings available. Change "09" to "01". Example: 610PX10501.

Polyurethane on Heavy Duty Cast Iron (28 Precision Ball Bearing)*							
PF		6	2 1/2	2900	8 1/2	1 3/4	610PF06428
		8	2 1/2	3100	10 1/2	2 1/4	610PF08428
		8	3	4000	10 1/2	2 1/4	610PF08528
		10	3	4200	12 1/2	2 3/4	610PF10528

*Tapered Roller (09) bearings available. Change "01" to "09". Example: 610PF10509.

Vulkollan Thick Tread Polyurethane (09 Roller Bearing)*							
VX		6	3	3000	8 1/2	1 3/4	610VX06509
		8	3	4000	10 1/2	2 1/4	610VX08509
		10	3	5000	12 1/2	2 3/4	610VX10509

*Roller (01) bearings available. Change "09" to "01". Example: 610VX10501.

X-treme Plus Solid Polyurethane (28 Precision Ball Bearing)							
XP		8	2 1/2	2000	10 1/2	2 1/4	610XP08428
		8	3	2000	10 1/2	2 1/4	610XP08528
		10	3	2500	12 1/2	2 3/4	610XP10528

Phenolic (01 Roller Bearing)*							
TM		6	2 1/2	1600	8 1/2	1 3/4	610TM06401
		6	3	2000	8 1/2	1 3/4	610TM06501
		8	2 1/2	2000	10 1/2	2 1/4	610TM08401
		8	3	2500	10 1/2	2 1/4	610TM08501
		10	3	2900	12 1/2	2 3/4	610TM10501
		12	3 1/2	4000	15 1/2	3 5/8	610TM12601
		12	4	8000	15 1/2	3 5/8	610TM12701

*Tapered Roller (09) bearings available. Change "01" to "09". Example: 610TM10509.

+ For swivel models add "S", for rigid model add "R" to end of base caster number.

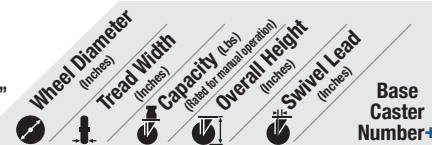

Trionix (28 Precision Ball Bearing)							
NX		6	2 1/2	7200	8 1/2	1 3/4	610NX06428
		6	3	7200	8 1/2	1 3/4	610NX06528
		8	2 1/2	7200	10 1/2	2 1/4	610NX08428
		8	3	7200	10 1/2	2 1/4	610NX08528
		10	3	7200	12 1/2	2 3/4	610NX10528

Cast Iron (01 Roller Bearing)*							
CA		6	3	2800	8 1/2	1 3/4	610CA06501
		8	2 1/2	2300	10 1/2	2 1/4	610CA08401
		8	3	2800	10 1/2	2 1/4	610CA08501
		8	4	4000	10 1/2	2 1/4	610CA08701
		10	3	2800	12 1/2	2 3/4	610CA10501
		10	4	4000	12 1/2	2 3/4	610CA10701

*Tapered Roller (09) bearings available. Change "01" to "09". Example: 610CA10509.

V-Grooved Cast Iron (01 Roller Bearing)*							
VG		6	2 1/2	2500	8 1/2	1 3/4	610VG06401
		8	2 1/2	2500	10 1/2	2 1/4	610VG08401
		8	3	2500	10 1/2	2 1/4	610VG08501

*Tapered Roller (09) bearings available. Change "01" to "09". Example: 610VG10509.

Drop Forged V-Grooved Cast Iron (01 Roller Bearing)*							
VF		6	3	6000	8 1/2	1 3/4	610VF06501
		8	4	6000	10 1/2	2 1/4	610VF08701
		10	4	8350	12 1/2	2 3/4	610VF10701

*Tapered Roller (09) bearings available. Change "01" to "09". Example: 610VF10509.
Note: Capacity increases to 9500 lbs. with use of 09 bearings.

Drop Forged Steel (01 Roller Bearing)*							
FS		6	2 1/2	4000	8 1/2	1 3/4	610FS06401
		8	2 1/2	4000	10 1/2	2 1/4	610FS08401
		8	3	5400	10 1/2	2 1/4	610FS08501
		10	3	5400	12 1/2	2 3/4	610FS10501
		10	4	8350	12 1/2	2 3/4	610FS10701

*Tapered Roller (09) bearings available. Change "01" to "09". Example: 610FS10509. 6x2-1/2 capacity increases to 5000, 8x3 capacity increases to 5500, 10x3 capacity increases to 6000 and 10x4 capacity increases to 9500 with use of 09 bearings.

Heavy Duty Drop Forged Steel (01 Roller Bearing)*							
FH		8	3	6000	10 1/2	2 1/4	610FH08501
		10	3	6000	12 1/2	2 3/4	610FH10501

*Tapered Roller (09) bearings available. Change "01" to "09". Example: 610FH10509. 10x3 capacity increases to 6500 with use of 09 bearings. All FH models include 1" axle.

Ductile Iron Crowned Tread (01 Roller Bearing)*							
FR, FM, VM		6	2 1/2	3500	8 1/2	1 3/4	610FR06401
		6	3	6000	8 1/2	1 3/4	610FR06501
		8	3	6000	10 1/2	2 1/4	610FR08501
		10	3	6000	12 1/2	2 3/4	610FR10501

*Tapered Roller (09) available. Change "01" to "09". Example: 610FR06409.
Ductile Iron Flat Tread (FM) and V-Groove (VM) models available. Change FR wheel code to FM or VM. Example: 610FM06401.

600

Shockmaster™ Kingpinless Casters

CAPACITY TO 10000

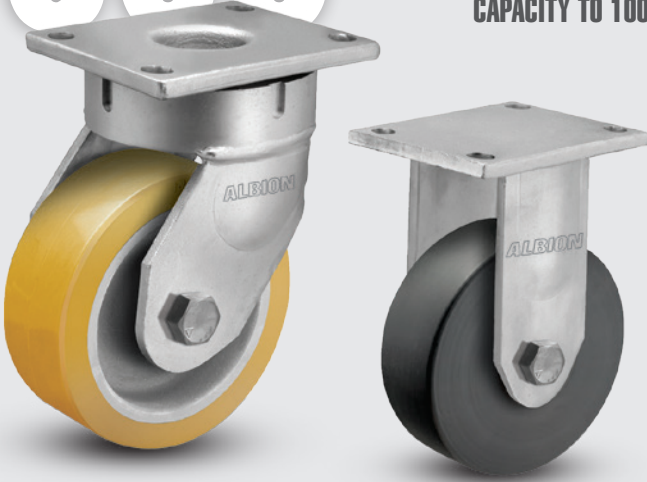

An added step up from the 610 (previous page), constructed of a one-piece forging for ultimate durability and strength. Highly recommended for automotive and aerospace applications. This caster is built to take the punishment of constant swiveling or for service where shock or impact loads would damage less rugged casters.

MOUNTING OPTIONS

Swivel Top Plate

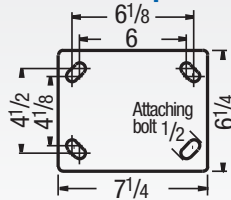

Rigid Top Plate

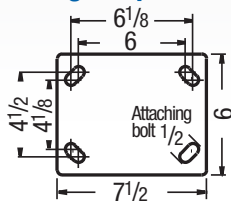

TYPICAL APPLICATIONS

- Body dolly carts
- Engine dollies
- Material carts
- Chassis rack carts
- Paint line dollies
- Towed trash gondolas

SWIVEL CROSS SECTION



+ For swivel models add "S", for rigid model add "R" to end of base caster number.

Moldon Rubber on Cast Iron (09 Tapered Roller Bearing)*

MR	Wheel Diameter (Inches)	Tread Width (Inches)	Capacity (Lbs) (Based on nominal operation)	Overall Height (Inches)	Swivel Lead (Inches)	Base Caster Number+
	6	2 1/2	700	8 1/2	2 1/2	600MR06409
	6	3	750	8 1/2	2 1/2	600MR06509
	8	2 1/2	850	10 1/2	2 1/2	600MR08409
	8	2 1/2**	850	10 1/2	2 1/2	600MH08409
	8	3	900	10 1/2	2 1/2	600MR08509
	10	3	1000	12 1/2	2 1/2	600MR10509
	10	3**	1000	12 1/2	2 1/2	600MH10509
	10	4	1400	12 1/2	2 1/2	600MR10709
	12	3 1/2	1500	15 1/2	2 1/2	600MR12609
	12	4	1600	15 1/2	2 1/2	600MR12709

*Roller (01) bearings available. Change "09" to "01". Example: 600MR10501.

**Heavy-duty MH version of wheel.



Premium Quality



Towing^



Environmentally Friendly

FEATURES

- **Top Plate:** 1/2" thick AISI 1045 steel one-piece forging precision machined and for long life
- **Swivel Section:** 3/4" ball bearings mounted in a 4-1/2" precision machined raceway. ZerK in swivel section
- **Legs:** 3/8" thick steel welded to yoke base using 100,000 psi weld filler
- **Axle:** 1" diameter
- Alternate or custom caster configurations available

RIG OPTIONS

- Spring-loaded, dual wheel models available, consult factory
- Notched yoke base for swivel locks specify **NY600**

BRAKE OPTIONS

To order, add brake code below to end of model. Example: 600PY08409SP

Poly Cam specify **P**



PLB Integrated specify **PLB**



Single Side specify **SSB610**. **Double Sided** specify **DSB610**



Face Contact specify **F**

Hand Operated Detachable Swivel Lock specify **L**.



BEARING OPTIONS



Straight Roller (01)



Tapered Roller (09)



Precision Ball (28)



Radial Ball (27)

+ For swivel models add "S", for rigid model add "R" to end of base caster number.

Wheel Diameter (Inches)	Tread Width (Inches)	Capacity (Lbs) (Based on nominal operation)	Overall Height (Inches)	Swivel Lead (Inches)	Base Caster Number+
-------------------------	----------------------	---	-------------------------	----------------------	---------------------

Polyurethane on Aluminum (01 Roller Bearing)*

PD	Wheel Diameter (Inches)	Tread Width (Inches)	Capacity (Lbs)	Overall Height (Inches)	Swivel Lead (Inches)	Base Caster Number+
	8	2 1/2	2010	10 1/2	2 1/2	600PD08401
	8	3	2520	10 1/2	2 1/2	600PD08501
	10	2 1/2	2370	12 1/2	2 1/2	600PD10401
	10	3	3000	12 1/2	2 1/2	600PD10501

*Tapered Roller (09) bearings available. Change "01" to "09". Example: 600PD08409.

Polyurethane on Cast Iron (09 Tapered Roller Bearing)*

PY	Wheel Diameter (Inches)	Tread Width (Inches)	Capacity (Lbs)	Overall Height (Inches)	Swivel Lead (Inches)	Base Caster Number+
	6	2 1/2	1600	8 1/2	2 1/2	600PY06409
	6	3	2000	8 1/2	2 1/2	600PY06509
	8	2 1/2	2000	10 1/2	2 1/2	600PY08409
	8	3	2500	10 1/2	2 1/2	600PY08509
	8	4	3800	10 1/2	2 1/2	600PY08709
	10	3	3000	12 1/2	2 1/2	600PY10509
	10	4	4200	12 1/2	2 1/2	600PY10709
	12	3 1/2	4110	15 1/2	2 1/2	600PY12609
	12	4	4800	15 1/2	2 1/2	600PY12709

*Roller (01) bearings available. Change "09" to "01". Example: 600PY06401.

Continue on next page >>

+ For swivel models add "S", for rigid model add "R" to end of base caster number.

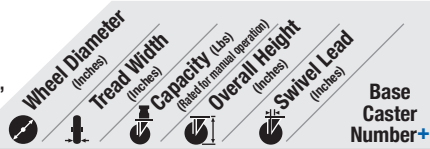

Thick Tread Polyurethane (09 Tapered Roller Bearing)*

PX	Wheel Diameter (inches)	Tread Width (inches)	Capacity (lbs) (Based on manual operation)	Overall Height (inches)	Swivel Lead (inches)	Base Caster Number+
	6	3	2250	8 1/2	2 1/2	600PX06509
	8	3	2780	10 1/2	2 1/2	600PX08509
	8	4	3850	10 1/2	2 1/2	600PX08709
	10	3	3300	12 1/2	2 1/2	600PX10509
	10	4	4620	12 1/2	2 1/2	600PX10709
	12	4	5280	15 1/2	2 1/2	600PX12709

*Roller (01) bearings available. Change "09" to "01".
Example: 600PX10501.

Vulkollan on Cast Iron (09 Tapered Roller Bearing)*

VY	Wheel Diameter (inches)	Tread Width (inches)	Capacity (lbs) (Based on manual operation)	Overall Height (inches)	Swivel Lead (inches)	Base Caster Number+
	6	2 1/2	2350	8 1/2	2 1/2	600VY06409
	6	3	3000	8 1/2	2 1/2	600VY06509
	8	2 1/2	2900	10 1/2	2 1/2	600VY08409
	8	3	4000	10 1/2	2 1/2	600VY08509
	10	2 1/2	3450	12 1/2	2 1/2	600VY10409
	10	3	5000	12 1/2	2 1/2	600VY10509

*Roller (01) bearings available. Change "09" to "01".
Example: 600VY10501.

Vulkollan Thick Tread Polyurethane (09 Tapered Roller Bearing)*

VX	Wheel Diameter (inches)	Tread Width (inches)	Capacity (lbs) (Based on manual operation)	Overall Height (inches)	Swivel Lead (inches)	Base Caster Number+
	6	2 1/2	2350	8 1/2	2 1/2	600VX06409
	6	3	3000	8 1/2	2 1/2	600VX06509
	8	2 1/2	2900	10 1/2	2 1/2	600VX08409
	8	3	4000	10 1/2	2 1/2	600VX08509
	10	2 1/2	3450	12 1/2	2 1/2	600VX10409
	10	3	5000	12 1/2	2 1/2	600VX10509

*Roller (01) bearings available. Change "09" to "01".
Example: 600VX10501.

X-treme Plus Solid Polyurethane (01 Roller Bearing)*

XP	Wheel Diameter (inches)	Tread Width (inches)	Capacity (lbs) (Based on manual operation)	Overall Height (inches)	Swivel Lead (inches)	Base Caster Number+
	8	2 1/2	2000	10 1/2	2 1/2	600XP08401
	8	3	2000	10 1/2	2 1/2	600XP08501
	10	3	2500	12 1/2	2 1/2	600XP10501

*Precision Ball (28) bearings available. Change "01" to "28".

Phenolic (01 Roller Bearing)*

TM	Wheel Diameter (inches)	Tread Width (inches)	Capacity (lbs) (Based on manual operation)	Overall Height (inches)	Swivel Lead (inches)	Base Caster Number+
	6	2 1/2	1600	8 1/2	2 1/2	600TM06401
	6	3	2000	8 1/2	2 1/2	600TM06501
	8	2 1/2	2000	10 1/2	2 1/2	600TM08401
	8	3	2500	10 1/2	2 1/2	600TM08501
	10	3	2900	12 1/2	2 1/2	600TM10501
	12	3 1/2	4000	15 1/2	2 1/2	600TM12601
	12	4	8000	15 1/2	2 1/2	600TM12701

*Tapered Roller (09) bearings available. Change "01" to "09".
Example: 600TM10509.

Trionix™ High Impact Polymer (28 Precision Ball Bearing)

NX	Wheel Diameter (inches)	Tread Width (inches)	Capacity (lbs) (Based on manual operation)	Overall Height (inches)	Swivel Lead (inches)	Base Caster Number+
	6	2 1/2	7200	8 1/2	2 1/2	600NX06428
	6	3	7200	8 1/2	2 1/2	600NX06528
	8	2 1/2	7200	10 1/2	2 1/2	600NX08428
	8	3	7200	10 1/2	2 1/2	600NX08528
	10	2 1/2	7200	12 1/2	2 1/2	600NX10428
	10	3	7200	12 1/2	2 1/2	600NX10528

+ For swivel models add "S", for rigid model add "R" to end of base caster number.

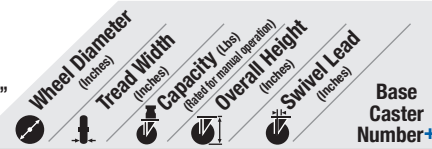

Cast Iron (01 Roller Bearing)*

CA	Wheel Diameter (inches)	Tread Width (inches)	Capacity (lbs) (Based on manual operation)	Overall Height (inches)	Swivel Lead (inches)	Base Caster Number+
	6	3	2800	8 1/2	2 1/2	600CA06501
	8	2 1/2	2300	10 1/2	2 1/2	600CA08401
	8	3	2800	10 1/2	2 1/2	600CA08501
	8	4	4000	10 1/2	2 1/2	600CA08701
	10	3	2800	12 1/2	2 1/2	600CA10501
	10	4	4000	12 1/2	2 1/2	600CA10701

*Tapered Roller (09) bearings available. Change "01" to "09".
Example: 600CA10509.

V-Grooved Cast Iron (01 Roller Bearing)*

VG	Wheel Diameter (inches)	Tread Width (inches)	Capacity (lbs) (Based on manual operation)	Overall Height (inches)	Swivel Lead (inches)	Base Caster Number+
	6	2 1/2	2500	8 1/2	2 1/2	600VG06401
	8	2 1/2	2500	10 1/2	2 1/2	600VG08401
	8	3	2500	10 1/2	2 1/2	600VG08501

*Tapered Roller (09) bearings available. Change "01" to "09".
Example: 600VG06409.

Drop Forged V-Grooved Cast Iron (01 Roller Bearing)*

VF	Wheel Diameter (inches)	Tread Width (inches)	Capacity (lbs) (Based on manual operation)	Overall Height (inches)	Swivel Lead (inches)	Base Caster Number+
	6	3	6000	8 1/2	2 1/2	600VF06501
	8	4	8350	10 1/2	2 1/2	600VF08701
	10	4	8350	12 1/2	2 1/2	600VF08701

*Tapered Roller (09) bearings available. Change "01" to "09".
Example: 600VF06509.
Note: Capacity increases to 10000 lbs. if specifying tapered roller bearing.

Drop Forged Steel (01 Roller Bearings)*

FS	Wheel Diameter (inches)	Tread Width (inches)	Capacity (lbs) (Based on manual operation)	Overall Height (inches)	Swivel Lead (inches)	Base Caster Number+
	6	2 1/2	4000	8 1/2	2 1/2	600FS06401
	8	2 1/2	4000	10 1/2	2 1/2	600FS08401
	8	3	4500	10 1/2	2 1/2	600FS08501
	10	3	5000	12 1/2	2 1/2	600FS10501
	10	4	8350	12 1/2	2 1/2	600FS10701

*Tapered Roller (09) bearings available. Change "01" to "09".
Example: 600FS10509. 6x2-1/2 capacity increases to 5000, 8x3 capacity increases to 5500, 10x3 capacity increases to 6000, 10x4 capacity increases to 10,000 with use of 09 bearing.

Heavy Duty Drop Forged Steel (01 Roller Bearings)*

FH	Wheel Diameter (inches)	Tread Width (inches)	Capacity (lbs) (Based on manual operation)	Overall Height (inches)	Swivel Lead (inches)	Base Caster Number+
	8	3	6500	10 1/2	2 1/2	600FH08501
	10	3	6000	12 1/2	2 1/2	600FH10501

*Tapered Roller (09) bearings available. Change "01" to "09".
Example: 600FH10509. 10x3 capacity increases to 6500 with use of 09 bearing.

Ductile Iron Crowned Tread (01 Roller Bearing)*

FR, FM, VM	Wheel Diameter (inches)	Tread Width (inches)	Capacity (lbs) (Based on manual operation)	Overall Height (inches)	Swivel Lead (inches)	Base Caster Number+
	6	2 1/2	3500	8 1/2	2 1/2	600FR06401
	6	3	6000	8 1/2	2 1/2	600FR06501
	8	3	6000	10 1/2	2 1/2	600FR08501
	10	3	6000	12 1/2	2 1/2	600FR10501

*Tapered Roller (09) available. Change "01" to "09". Example: 600FR08509.
Ductile Iron Flat Tread (FM) and V-Groove (VM) models available. Change FR wheel code to FM or VM. Example: 600FM08501.

600 SERIES • CAPACITY TO 10000

HEAVY DUTY KINGPINLESS

700

Shockmaster™ Kingpinless Casters

CAPACITY TO 20000



These super duty casters are built specifically for that potentially punishing application where reliability is essential. One-piece forging is precision machined and carefully constructed to deliver the utmost durability in handling shock and impact.

TYPICAL APPLICATIONS

- Aircraft engine stands
- Ground support equipment
- Aerospace A-frame skin dollies
- Portable jigs
- Tooling fixtures
- Die carts
- Large platform work

SWIVEL CROSS SECTION



+ For swivel models add "S", for rigid model add "R" to end of base caster number.

Wheel Diameter (Inches)	Tread Width (Inches)	Capacity (Lbs) (Roller for manual operation)	Overall Height (Inches)	Swivel Lead (Inches)	Base Caster Number+
-------------------------	----------------------	---	-------------------------	----------------------	---------------------

Moldon Rubber on Cast Iron (09 Tapered Roller Bearing)

MR	Wheel Diameter (Inches)	Tread Width (Inches)	Capacity (Lbs) (Roller for manual operation)	Overall Height (Inches)	Swivel Lead (Inches)	Base Caster Number+
	10	4	1400	13	2 1/2	700MR10709
	12	4	1600	15 1/2	3 1/4	700MR12709
	16	4	2000	19	4 1/2	700MR16709
	16	5	2570	19	4 1/2	700MR16809

Polyurethane on Aluminum (09 Tapered Roller Bearing)

PA	Wheel Diameter (Inches)	Tread Width (Inches)	Capacity (Lbs) (Roller for manual operation)	Overall Height (Inches)	Swivel Lead (Inches)	Base Caster Number+
	12	6	7500	15 1/2	3 1/4	700PA12909



Premium Quality



Towing[^]



Environmentally Friendly

FEATURES

- **Top Plate:** 1/2" thick AISI 1045 steel one-piece forging precision machined and for long life
- **Swivel Section:** 3/4" ball bearings mounted in a 7" diameter precision machined raceway. Zerk in swivel section
- **Legs:** 1/2" thick steel welded to yoke base using 100,000 psi weld filler
- **Axle:** 1-1/4" diameter
- Alternate or custom caster configurations available

RIG OPTIONS

- Notched yoke base for swivel locks specify **NY700**
- Spring-loaded, dual wheel models available, consult factory

BRAKE OPTIONS

To order, add brake code below to end of model. Example: 700PY08709SP

Poly Cam
specify **P**



PLB Integrated
specify **PLB**

Face Contact
specify **F**



Hand Operated
Detachable **Swivel Lock**
specify **L**

BEARING OPTIONS



Straight Roller (01)

Tapered Roller (09)

+ For swivel models add "S", for rigid model add "R" to end of base caster number.

Wheel Diameter (Inches)	Tread Width (Inches)	Capacity (Lbs) (Roller for manual operation)	Overall Height (Inches)	Swivel Lead (Inches)	Base Caster Number+
-------------------------	----------------------	---	-------------------------	----------------------	---------------------

Polyurethane on Cast Iron (09 Tapered Roller Bearing)

PY	Wheel Diameter (Inches)	Tread Width (Inches)	Capacity (Lbs) (Roller for manual operation)	Overall Height (Inches)	Swivel Lead (Inches)	Base Caster Number+
	8	4	3800	11	2 1/4	700PY08709
	10	4	4200	13	2 1/2	700PY10709
	10	5	5000	13	2 1/2	700PY10809
	12	4	4800	15 1/2	3 1/4	700PY12709
	12	5	6000	15 1/2	3 1/4	700PY12809
	16	4	5970	19	4 1/2	700PY16709
	16	5	7700	19	4 1/2	700PY16809

Thick Tread Polyurethane (09 Tapered Roller Bearing)

PX	Wheel Diameter (Inches)	Tread Width (Inches)	Capacity (Lbs) (Roller for manual operation)	Overall Height (Inches)	Swivel Lead (Inches)	Base Caster Number+
	8	4	3850	11	2 1/4	700PX08709
	10	4	4620	13	2 1/2	700PX10709
	10	5	5500	13	2 1/2	700PX10809
	12	4	5820	15 1/2	3 1/4	700PX12709
	12	5	6600	15 1/2	3 1/4	700PX12809
	16	4	6570	19	4 1/2	700PX16709
	16	5	8470	19	4 1/2	700PX16809

Continue on next page >>

+ For swivel models add "S", for rigid model add "R" to end of base caster number.

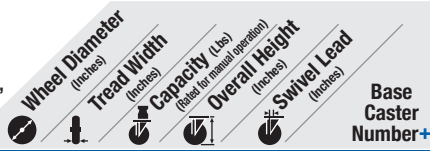

Phenolic (09 Tapered Roller Bearing)							
TM		12	4	8000	15 1/2	4 1/4	700TM12709

Cast Iron (09 Tapered Roller Bearing)							
CA		8	4	4000	11	2 1/4	700CA08709
		10	4	4000	13	2 1/2	700CA10709

V-Grooved Drop Forged (01 Roller Bearing/09 Tapered Roller Bearing)							
VF		8	4	10000	11	2 1/4	700VF08709
		10	4	8350	13	2 1/2	700VF10701

+ For swivel models add "S", for rigid model add "R" to end of base caster number.

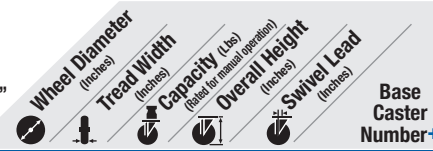

V-Grooved HD Drop Forged (09 Tapered Roller Bearing)							
VH		8	4	15000	11	2 1/4	700VH08709
		10	4	15000	13	2 1/2	700VH10709

Drop Forged Steel (09 Tapered Roller Bearing)							
FS		8	4	10000	11	2 1/4	700FS08709
		10	4	10000	13	2 1/2	700FS10709

Heavy Duty Drop Forged Steel (09 Tapered Roller Bearing)							
FH		8	4	20000	11	2 1/4	700FH08709
		10	4	20000	13	2 1/2	700FH10709

In addition to the Super Duty 700 Series . . . Albion has all your aviation needs covered

Air Cargo Section: see pages 118-121

Spring Loaded Section: see pages 87-99

Dual Wheel Section: see pages 100-112

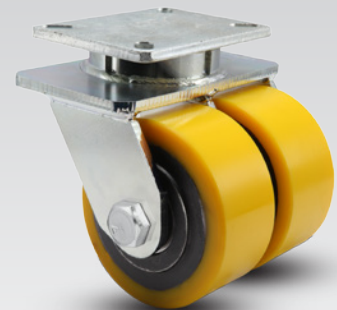
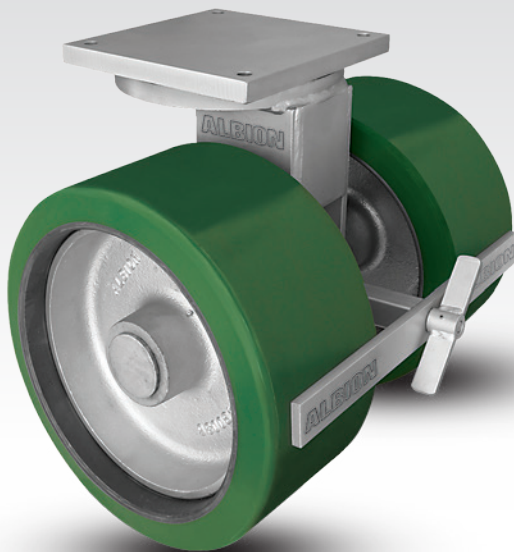

A LEADER IN USA MADE CASTERS & ENGINEERED SOLUTIONS.

USA designed, manufactured, and tested to provide the highest quality and value for your caster needs. All featuring Albion's industry leading 3 year warranty.



Designed and Made in the USA.



Medium Heavy Duty
16 SERIES with XR WHEEL – Page 24

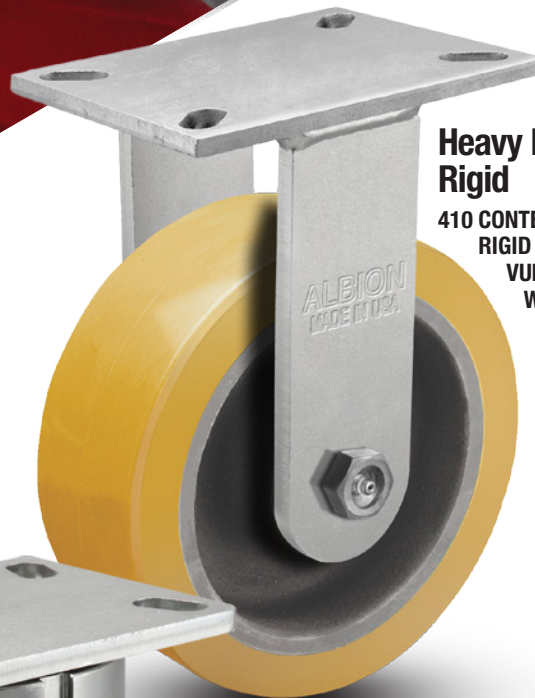

Heavy Duty Rigid
410 CONTENDER RIGID with VULKOLLAN WHEEL – PAGE 50



Heavy Duty Kingpinless
310 CONTENDER PLB BRAKE with THICK TREAD PX WHEEL – Page 48

Just look for this USA badge!



HEAVY DUTY KINGPIN CASTERS

CAPACITY RANGE 700-17000 LBS



95 Series
Heavy Duty Casters

Common Applications:

- Production Racks
- Utility Trucks
- Conveyor-drawn Tow-trucks
- Production Dollies
- Heavy Duty Bakery Racks
- Heavy Duty Trash Dumpsters
- Trailer Frames



81 Series Heavy Duty Casters
Capacity to 2000 **60-61**



94 BBL Series Super Duty Casters (Ball Load Swivel)
Capacity to 5000 **68-69**



90 Series Heavy Duty Casters
Capacity to 3500 **62-63**
Popular Series



94 TRL Series Super Duty Casters (Thrust Swivel Section)
Capacity to 10000 **70-71**



92 Series Heavy Duty Casters
Capacity to 4800 **64-65**



95 BBL Series Super Duty Casters (Ball Load Swivel)
Capacity to 8000 **72**
Popular Series



93 Series Heavy Duty Casters
Capacity to 7500 **66**



95 TRL Series Super Duty Casters (Thrust Swivel Section)
Capacity to 17000 **73-74**
Popular Series

Premium and Specialty Heavy Duty Casters That May Interest You ...

KINGPINLESS CASTERS



Need more protection from Shock or Impact? See the **Heavy Duty Kingpinless Section** (pages 41-58).

SPRING LOADED CASTERS



Want more shock absorption and a quieter ride? See the **Spring Loaded Section** (pages 87-89).

81

81 Heavy Duty Casters

CAPACITY TO 2000



Premium Quality



Environmentally Friendly



The 81 Series is drop forged and recommended for heavy manual moved loads or for medium duty power drawn equipment. Consult factory for all power drawn applications.

TYPICAL APPLICATIONS

- Conveyor-drawn tow-trucks
- Heavy duty bakery racks
- Production dollies
- Heavy duty dough troughs

SWIVEL CROSS SECTION

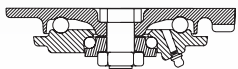

MOUNTING OPTIONS

Standard Plate

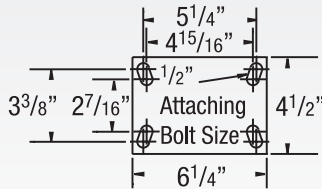

Special Order Plates

Optional W Plate

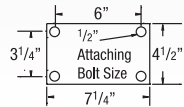

Optional D Plate

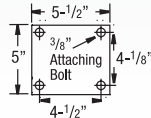

FEATURES

- **Top Plate:** Rugged AISI 1045 Drop forged steel for maximum strength
- **Swivel Section:** Double ball bearing coined "deep-groove" load and machined component thrust raceways
- **Legs:** 3/8" steel, engineered to increase strength and welded construction
- **King Bolt:** 3/4" diameter heat treated bolt and nut for enhanced load capacity
- **Axle:** 3/4" diameter, hollow, with lock nut
- **Lubrication:** Zerk fitting in swivel section and in recessed head of hollow axle
- Alternate or custom caster configurations available

RIG OPTIONS

- Neoprene **Sealed swivel** section specify **NS81**
- **Tapered thrust bearing** option available for special order. Consult factory

BRAKE OPTIONS

To order, add brake code below to end of model. Example: 81PY06401SP

Poly Cam specify **P**



Single Side specify **SSB81**. **Double Sided** specify **DSB81**

BEARING OPTIONS

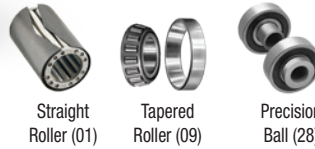

Straight Roller (01)

Tapered Roller (09)

Precision Ball (28)

Face Contact specify **F**



Wrap Around specify **WB81**

TOE GUARD



Specify **TOE** for caster integrated toe guard. Standard model toe guards are 1/2" from the floor. Consult factory for field installable options.

Face specify **FBB**



Welded Swivel Lock specify **L**



Hand Operated Detachable Swivel Lock order **SL81000** separately

+ For swivel models add "S", for rigid model add "R" to end of base caster number.

	Wheel Diameter (Inches)	Tread Width (Inches)	Capacity (Lbs) (Based on manual operation)	Overall Height (Inches)	Swivel Lead (Inches)	Approx. Wt. (Lbs)	Base Caster Number+
MR	6	2 1/2	700	7 5/8	3	20 1/2	81MR06401
	6	3	750	7 5/8	3	21 3/4	81MR06501
	8	2 1/2	850	10 1/8	3	20 1/4	81MR08401
	8	3	900	10 1/8	3	22 1/4	81MR08501
	10	2 1/2	950	11 1/2	3 1/2	24 1/2	81MR10401
	10	3	1000	11 1/2	3 1/2	25 1/4	81MR10501
	12	3	1200	13 1/2	3	30 3/4	81MR12501

Polyurethane on Aluminum (01 Roller Bearing)

	Wheel Diameter (Inches)	Tread Width (Inches)	Capacity (Lbs) (Based on manual operation)	Overall Height (Inches)	Swivel Lead (Inches)	Approx. Wt. (Lbs)	Base Caster Number+
PA/PD	4	3 1/4	1200	5 1/2	2	15	81PA04501
	8	2 1/2	2000	10 1/8	2 1/4	20 1/4	81PD08401
	8	3	2000	10 1/8	2 1/4	20 1/4	81PD08501
	10	2 1/2	2000	11 1/2	2 1/2	24 1/2	81PD10401
	10	3	2000	11 1/2	2 1/2	24 1/2	81PD10501
	12	3	2000	13 1/2	3		81PD12501

+ For swivel models add "S", for rigid model add "R" to end of base caster number.

	Wheel Diameter (Inches)	Tread Width (Inches)	Capacity (Lbs) (Based on manual operation)	Overall Height (Inches)	Swivel Lead (Inches)	Approx. Wt. (Lbs)	Base Caster Number+
PY	3 1/4	3 1/4	850	5 1/8	2	12	81PY03501
	5	2 1/2	1300	6 1/2	2 1/4	15	81PY05401
	6	2 1/2	1600	7 5/8	1 1/2	20 1/2	81PY06401
	6	3	2000	7 5/8	1 1/2	26	81PY06501
	8	2 1/2	2000	10 1/8	2 1/4	22 1/2	81PY08401
	8	3	2000	10 1/8	2 1/4	22 1/4	81PY08501
	10	3	2000	11 1/2	2 1/2	31	81PY10501
	12	2 1/2	2000	13 1/2	3	31 1/2	81PY12401
	12	3	2000	13 1/2	3	40	81PY12501

Continue on next page >>

+ For swivel models add "S", for rigid model add "R" to end of base caster number.

Wheel Diameter (Inches)	Tread Width (Inches)	Capacity (Lbs) (Rigid or normal operation)	Overall Height (Inches)	Swivel Lead (Inches)	Approx. Wk. (Lbs)	Base Caster Number+

Polyurethane on Cast Iron (01 Roller Bearing)								
	PY 80A	3 1/4	3 1/4	680	5 1/8	2	12	81PY0350180A
		5	2 1/2	1050	6 1/2	2 1/4	15	81PY0540180A
		6	2 1/2	1300	7 5/8	1 1/2	20 1/2	81PY0640180A
		6	3	1600	7 5/8	1 1/2	26	81PY0650180A
		8	2 1/2	1600	10 1/8	2 1/4	22 1/2	81PY0840180A
		8	3	2000	10 1/8	2 1/4	22 1/4	81PY0850180A
		10	3	2000	11 1/2	2 1/2	31	81PY1050180A
		12	2 1/2	2000	13 1/2	3	31 1/2	81PY1240180A
		12	3	2000	13 1/2	3	40	81PY1250180A

To Specify Rigid or Swivel, insert "R" or "S" before "80A".
Example: 81PY08228R80A.

Polyurethane on Iron (01 Roller Bearing)								
	PI	6	2 1/2	1600	7 5/8	1 1/2	20 1/2	81PI06401
		6	3	2000	7 5/8	1 1/2	26	81PI06501
		8	2 1/2	2000	10 1/8	2 1/4	22 1/2	81PI08401
		8	3	2000	10 1/8	2 1/4	22 1/4	81PI08501
		10	3	2000	11 1/2	2 1/2	31	81PI10501
		12	2 1/2	2000	13 1/2	3	31 1/2	81PI12401
	12	3	2000	13 1/2	3	40	81PI12501	

Thick Tread Polyurethane (01 Roller Bearing)								
	PX	6	3	2000	7 5/8	1 1/2	26	81PX06501
		8	3	2000	10 1/8	2 1/4	22 1/4	81PX08501
		10	3	2000	11 1/2	2 1/2	31	81PX10501
		12	3	2000	13 1/2	3	40	81PX12501

Vulkollan on Cast Iron (09 Tapered Roller Bearing)*								
	VY	6	2 1/2	2000	7 5/8	1 1/2	20 1/2	81VY06409
		6	3	2000	7 5/8	1 1/2	26	81VY06509
		8	2 1/2	2000	10 1/8	2 1/4	22 1/2	81VY08409
		8	3	2000	10 1/8	2 1/4	22 1/4	81VY08509
		10	3	2000	11 1/2	2 1/2	31	81VY10509

*Roller (01) and Precision Ball (28) Bearings available.
Change "09" to other bearing code. Roller example: 81VY06501.

Vulkollan Thick Tread Polyurethane (09 Tapered Roller Bearing)*								
	VX	6	3	2000	7 5/8	1 1/2	26	81VX06509
		8	3	2000	10 1/8	2 1/4	22 1/4	81VX08509
		10	3	2000	11 1/2	2 1/2	31	81VX10509

*Roller (01) and Precision Ball (28) Bearings available.
Change "09" to other bearing code. Roller example: 81VX06501.

X-treme Plus Solid Polyurethane (01 Roller Bearing)*								
	XP	8	2 1/2	2000	10 1/8	2 1/4	22 1/2	81XP08401
		8	3	2000	10 1/8	2 1/4	22 1/4	81XP08501
		10	2 1/2	2000	11 1/2	2 1/2	24 1/2	81XP10401
		10	3	2000	11 1/2	2 1/2	31	81XP10501

*Precision Ball (28) Bearings available.
Change "01" to other bearing code. Example: 81XP08428.

Phenolic (01 Roller Bearing)								
	TM	6	2 1/2	1600	7 5/8	1 1/2	14 1/4	81TM06401
		6	3	2000	7 5/8	1 1/2	14 3/4	81TM06501
		8	2 1/2	2000	10 1/8	2 1/4	16 3/4	81TM08401
		8	3	2000	10 1/8	2 1/4	17 3/4	81TM08501
		10	3	2000	11 1/2	2 1/2	20 1/2	81TM10501
		12	3	2000	13 1/2	3	22 1/2	81TM12501

+ For swivel models add "S", for rigid model add "R" to end of base caster number.

Wheel Diameter (Inches)	Tread Width (Inches)	Capacity (Lbs) (Rigid or normal operation)	Overall Height (Inches)	Swivel Lead (Inches)	Approx. Wk. (Lbs)	Base Caster Number+

Trionix™ High Impact Polymer (28 Precision Ball Bearing)								
	NX	6	2 1/2	2000	7 5/8	1 1/2	15	81NX06428
		6	3	2000	7 5/8	1 1/2	16	81NX06528
		8	2 1/2	2000	10 1/8	2 1/4	17	81NX08428
		8	3	2000	10 1/8	2 1/4	18	81NX08528
		10	2 1/2	2000	11 1/2	3 1/2	19 3/4	81NX10428
		10	3	2000	11 1/2	2 1/2	21	81NX10528

Cast Iron (01 Roller Bearing)								
	CA	4	3	2000	5 1/2	2	17 3/4	81CA04501
		5	2 1/2	2000	6 1/2	2 1/4	19 1/2	81CA05401
		6	2 1/2	2000	7 5/8	1 1/2	20 1/4	81CA06401
		8	3	2000	10 1/8	2 1/4	26 1/2	81CA08501
		10	3	2000	11 1/2	2 1/2	27 1/2	81CA10501

Drop Forged Steel (01 Roller Bearing)								
	FS	6	2 1/2	2000	7 5/8	1 1/2	21 3/4	81FS06401
		8	3	2000	10 1/8	2 1/4	26 1/2	81FS08501

V-Grooved Cast Iron (01 Roller Bearing)								
	VG	6	2 1/2	2000	7 5/8	1 1/2	20 1/4	81VG06401
		8	3	2000	10 1/8	2 1/4	26 1/2	81VG08501
		10	3	2000	11 1/2	2 1/2	27 1/2	81VG10501

Ductile Iron Crowned Tread (01 Roller Bearing)*								
	FR, FM	6	2 1/2	2000	7 5/8	1 1/2	20 1/4	81FR06401
		8	3	2000	10 1/8	2 1/4	26 1/2	81FR08501
		10	3	2000	11 1/2	2 1/2	27 1/2	81FR10501

*Tapered Roller (09) and Precision Ball (28) bearings available.
Tapered Roller example: 81FR06409.
Ductile Iron Flat Tread (FM) and V-Groove (VM) models available.
Change FR wheel code to FM or VM. Example: 81FM06401.

90

90 Heavy Duty Casters

CAPACITY TO 3500



Our popular 90 Series is made from AISI 1045 drop forged steel and is highly recommended for rugged heavy duty applications.

TYPICAL APPLICATIONS

- Heavy duty power drawn equipment
- High capacity die tables
- Portable work benches
- Machinery dollies
- Heavy production fixtures or jigs
- Corrugated steel box trucks
- Heavy portable storage racks

SWIVEL CROSS SECTION

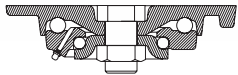

MOUNTING OPTIONS Standard Plate

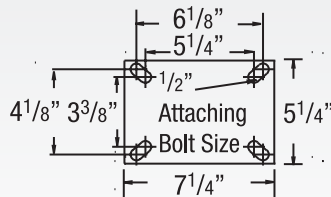

Special Order Plate Optional W Plate

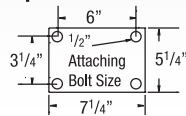

FEATURES

- **Swivel Top Plate:** AISI 1045 drop forged steel, for strength and reliability
- **Yoke Base:** AISI 1045 drop forged steel with machined raceway for extended service life
- **Swivel Load Bearing:** 4" diameter deep-grooved load raceway with 1/2" steel balls for better load distribution. The thrust race is 2-5/8" diameter using 3/8" diameter steel balls for increased capacity
- **Legs:** 3/8" steel plate welded inside and out for added strength
- **King Bolt:** 1" diameter bolt heat treated for extended service
- **Axle:** 3/4" and 1" hollow axles are used for wheel bearing lubrication
- **Lubrication:** Zerk fitting in yoke base and in wheel hub or recessed in head of hollow axle
- Alternate or custom caster configurations available

BEARING OPTIONS

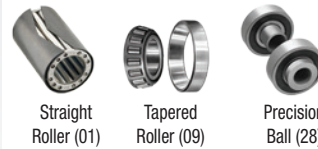

TOE GUARD



Specify **TOE** for caster integrated toe guard. Standard model toe guards are 1/2" from the floor. Consult factory for field installable options.

RIG OPTIONS

- **Sealed swivel** section specify **NS90**
- **Heat treated raceway** specify **HT03**
- **Tapered thrust bearing** option available for special order. Consult factory

BRAKE OPTIONS

To order, add brake code below to end of model. Example: 90PY06401SP

Poly Cam specify **P**



Single Side specify **SSB90**. **Double Sided** specify **DSB90**

Face Contact specify **F**



Wrap Around specify **WB90**

PLB Integrated specify **PLB**



Face specify **FBB** (3" tread width only)

Welded Swivel Lock specify **L**



Hand operated field Installable Swivel Lock order **SL900000** separately

	Wheel Diameter (Inches)	Tread Width (Inches)	Capacity (Lbs) (Rated for normal operation)	Overall Height (Inches)	Swivel Lead (Inches)	Approx. Wt. (Lbs)	Base Caster Number+
--	-------------------------	----------------------	---	-------------------------	----------------------	-------------------	---------------------

Moldon Rubber on Cast Iron (01 Roller Bearing)*

MR	Wheel Diameter (Inches)	Tread Width (Inches)	Capacity (Lbs) (Rated for normal operation)	Overall Height (Inches)	Swivel Lead (Inches)	Approx. Wt. (Lbs)	Base Caster Number+
6	2 1/2	700	8	2 1/4	22	90MR06401	
6	3	750	8	2 1/4	23 3/4	90MR06501	
8	2 1/2	850	10 1/2	2 1/2	27 1/4	90MR08401	
8	3	900	10 1/2	2 1/2	27 1/4	90MR08501	
10	2 1/2	950	12 1/2	2 1/2	29 1/2	90MR10401	
10	3	1000	12 1/2	2 1/2	30 1/2	90MR10501	
10	3 1/2	1800	12 1/2	2 1/2	30 1/2	90MH10501	
10	4 2	1400	12 1/2	2 1/2	44 1/2	90MR10701	
12	2 1/2	2500	15 1/2	2 1/2	35	90MR12401	
12	3	1200	15 1/2	2 1/2	36 1/4	90MR12501	

* (09) Tapered Roller Bearings available. Change "01" to other bearing code. Tapered Roller example: 90MR06509. ¹Heavy-duty MH version of 10x3 wheel. ²10 x 4 model has solid axle; all others hollow axle.

+ For swivel models add "S", for rigid model add "R" to end of base caster number.

Polyurethane on Aluminum (01 Roller Bearing)

PA/PD	Wheel Diameter (Inches)	Tread Width (Inches)	Capacity (Lbs) (Rated for normal operation)	Overall Height (Inches)	Swivel Lead (Inches)	Approx. Wt. (Lbs)	Base Caster Number+
4	3 1/4	1200	6	2	17 1/4	90PA04501	
4	4	1600	6	2	20 1/2	90PA04701*	
8	2 1/2	2010	10 1/2	2 1/2	21 1/2	90PD08401	
8	3	2520	10 1/2	2 1/2	22 1/2	90PD08501	
10	2 1/2	2370	12 1/2	2 1/2	24	90PD10401	
10	3	3000	12 1/2	2 1/2	25	90PD10501	

*1" solid axle.

Continue on next page >>

+ For swivel models add "S", for rigid model add "R" to end of base caster number.

Wheel Diameter (Inches)
Tread Width (Inches)
Capacity (Lbs) (Based on manual operation)
Overall Height (Inches)
Swivel Lead (Inches)
Approx. Wt. (Lbs)
Base Caster Number+

Polyurethane on Cast Iron (09 Tapered Roller Bearing)*

Model	Wheel Diameter	Tread Width	Capacity	Overall Height	Swivel Lead	Approx. Wt.	Base Caster Number
PI	6	2 1/2	1600	8	2 1/4	20	90PI06409
	6	3	2000	8	2 1/4	21	90PI06509
	8	2 1/2	2000	10 1/2	2 1/2	22	90PI08409
	8	3	2500	10 1/2	2 1/2	24 1/4	90PI08509
	10	2 1/2	2200	12 1/2	2 1/2	25 1/2	90PI10409
	10	3	3000	12 1/2	2 1/2	28	90PI10509
	12	2 1/2	2500	15 1/2	2 1/2	35	90PI12409
	12	3	3500	15 1/2	2 1/2	38	90PI12509

*Roller (01) bearings available. Change "01" to other bearing code. Example: 90PI06501.

Polyurethane* on Cast Iron (01 Roller Bearing, 09 Tapered Roller Bearing)

Model	Wheel Diameter	Tread Width	Capacity	Overall Height	Swivel Lead	Approx. Wt.	Base Caster Number
PY	3 1/4	4 1/4	1100	5 5/8	2	17 1/2	90PY03709
	5	3	1500	7	2 1/2	23	90PY05501
	6	2 1/2	1600	8	2 1/4	25	90PY06401
	6	3	2000	8	2 1/4	26 3/4	90PY06501
	8	2 1/2	2000	10 1/2	2 1/2	27 3/4	90PY08401
	8	3	2500	10 1/2	2 1/2	31	90PY08501
	10	3	3000	12 1/2	2 1/2	35 3/4	90PY10501
	12	3	3500	15 1/2	2 1/2	44 1/4	90PY12501

Polyurethane on Cast Iron (01 Roller Bearing, 09 Tapered Roller Bearing)

Model	Wheel Diameter	Tread Width	Capacity	Overall Height	Swivel Lead	Approx. Wt.	Base Caster Number
PY 80A	3 1/4	4 1/4	880	5 5/8	2	17 1/2	90PY0370980A
	5	3	1220	7	2 1/2	23	90PY0550180A
	6	2 1/2	1300	8	2 1/4	25	90PY0640180A
	6	3	1600	8	2 1/4	26 3/4	90PY0650180A
	8	2 1/2	1600	10 1/2	2 1/2	27 3/4	90PY0840180A
	8	3	2000	10 1/2	2 1/2	31	90PY0850180A
	10	3	2400	12 1/2	2 1/2	35 3/4	90PY1050180A
	12	3	3500	15 1/2	2 1/2	44 1/4	90PY1250180A

To Specify Rigid or Swivel, insert "R" or "S" before "80A." Example: 90PY08401R80A.

Thick Tread Polyurethane* (09 Tapered Roller Bearing)

Model	Wheel Diameter	Tread Width	Capacity	Overall Height	Swivel Lead	Approx. Wt.	Base Caster Number
PX	6	3	2250	8	2 1/4	27	90PX06509
	8	2 1/2	2200	10 1/2	2 1/2	27	90PX08409
	8	3	2780	10 1/2	2 1/2	31 1/2	90PX08509
	10	3	3300	12 1/2	2 1/2	36	90PX10509
	12	3	3500	15 1/2	2 1/2	44 1/2	90PX12509

Vulkollan on Cast Iron (09 Tapered Roller Bearing)*

Model	Wheel Diameter	Tread Width	Capacity	Overall Height	Swivel Lead	Approx. Wt.	Base Caster Number
VY	6	2 1/2	2350	8	2 1/4	25	90VY06409
	6	3	3000	8	2 1/4	26 3/4	90VY06509
	8	2 1/2	2900	10 1/2	2 1/2	27 3/4	90VY08409
	8	3	3500	10 1/2	2 1/2	31	90VY08509
	10	3	3500	12 1/2	2 1/2	35 3/4	90VY10509

*Roller (01) and Precision Ball (28) bearings available. Change "01" to other bearing code. Precision example: 90VY06528.

Thick Tread Vulkollan (09 Tapered Roller Bearing)*

Model	Wheel Diameter	Tread Width	Capacity	Overall Height	Swivel Lead	Approx. Wt.	Base Caster Number
VX	6	3	3000	8	2 1/4	27	90VX06509
	8	2 1/2	2900	10 1/2	2 1/2	27	90VX08409
	8	3	3500	10 1/2	2 1/2	31 1/2	90VX08509
	10	3	3500	12 1/2	2 1/2	36	90VX10509

*Roller (01) and Precision Ball (28) bearings available. Change "01" to other bearing code. Precision example: 90VX06528.

X-treme Plus Solid Polyurethane (28 Precision Ball Bearing)

Model	Wheel Diameter	Tread Width	Capacity	Overall Height	Swivel Lead	Approx. Wt.	Base Caster Number
XP	8	2 1/2	2000	10 1/2	2 1/2	22 1/2	90XP08428
	8	3	2000	10 1/2	2 1/2	22 1/4	90XP08528
	10	2 1/2	2500	12 1/2	2 1/2	24 1/2	90XP10428
	10	3	2500	12 1/2	2 1/2	31	90XP10528

*Durometers available on Polyurethane wheels can be 80A, 95A, 60D and 70D. Consult factory.

+ For swivel models add "S", for rigid model add "R" to end of base caster number.

Wheel Diameter (Inches)
Tread Width (Inches)
Capacity (Lbs) (Based on manual operation)
Overall Height (Inches)
Swivel Lead (Inches)
Approx. Wt. (Lbs)
Base Caster Number+

Phenolic (01 Roller Bearing)

Model	Wheel Diameter	Tread Width	Capacity	Overall Height	Swivel Lead	Approx. Wt.	Base Caster Number
TM	6	2 1/2	1600	8	2 1/4	18 3/4	90TM06401
	6	3	2000	8	2 1/4	19 1/4	90TM06501
	8	2 1/2	2000	10 1/2	2 1/2	21 1/4	90TM08401
	8	3	2500	10 1/2	2 1/2	22 1/4	90TM08501
	10	3	2900	12 1/2	2 1/2	25 1/4	90TM10501
	12	3	3500	15 1/2	2 1/2	29 1/4	90TM12501

Trionix™ High Impact Polymer (28 Precision Ball Bearing)

Model	Wheel Diameter	Tread Width	Capacity	Overall Height	Swivel Lead	Approx. Wt.	Base Caster Number
NX	6	2 1/2	3500	8	2 1/4	20 1/2	90NX06428
	6	3	3500	8	2 1/4	21 1/2	90NX06528
	8	2 1/2	3500	10 1/2	2 1/2	23 3/4	90NX08428
	8	3	3500	10 1/2	2 1/2	24 1/2	90NX08528
	10	2 1/2	3500	12 1/2	2 1/2	26 1/2	90NX10428
	10	3	3500	12 1/2	2 1/2	28	90NX10528

Cast Iron (01 Roller Bearing, 09 Tapered Roller Bearing)

Model	Wheel Diameter	Tread Width	Capacity	Overall Height	Swivel Lead	Approx. Wt.	Base Caster Number
CA	3 1/4	4	2000	5 5/8	2	21	90CA03709
	4	3	2000	6	2	21 3/4	90CA04501
	4	4	3500	6	2	27 1/4	90CA04701
	5	2 1/2	2000	7	2 1/2	24	90CA05401
	6	3	2800	8	2 1/4	26	90CA06501
	8	3	2800	10 1/2	2 1/2	26 3/4	90CA08501
	10	3	2800	12 1/2	2 1/2	32 1/2	90CA10501
	12	3	2800	15 1/2	2 1/2	38 1/2	90CA12501

Forged Steel (01 Roller Bearing)

Model	Wheel Diameter	Tread Width	Capacity	Overall Height	Swivel Lead	Approx. Wt.	Base Caster Number
FS	6	2 1/2	3500	8	2 1/4	26	90FS06401
	8	2 1/2	3500	10 1/2	2 1/2	21 3/4	90FS08401
	8	3	3500	10 1/2	2 1/2	33 1/4	90FS08501
	10	3	3500	12 1/2	2 1/2	43 1/4	90FS10501

V-Groove Cast Iron (01 Roller Bearing)

Model	Wheel Diameter	Tread Width	Capacity	Overall Height	Swivel Lead	Approx. Wt.	Base Caster Number
VG	6	2 1/2	2500	8	2 1/4	26 1/4	90VG06401
	8	3	2500	10 1/2	2 1/2	31 1/4	90VG08501
	10	3	3000	12 1/2	2 1/2	42 1/2	90VG10501

Ductile Iron Crowned Tread (01 Roller Bearing)*

Model	Wheel Diameter	Tread Width	Capacity	Overall Height	Swivel Lead	Approx. Wt.	Base Caster Number
FR	6	2 1/2	3500	8	2 1/4	26	90FR06401
	6	3	3500	8	2 1/4	26	90FR06501
	8	3	3500	10 1/2	2 1/2	26 3/4	90FR08501
	10	3	3500	12 1/2	2 1/2	32 1/2	90FR10501

*Tapered Roller (09) and Precision Ball (28) bearings available. Change "01" to other bearing code. Tapered Roller example: 90FR08409.

Ductile Iron Flat Tread (01 Roller Bearing)*

Model	Wheel Diameter	Tread Width	Capacity	Overall Height	Swivel Lead	Approx. Wt.	Base Caster Number
FM	6	2 1/2	3500	8	2 1/4	26	90FM06401
	6	3	3500	8	2 1/4	26	90FM06501
	8	3	3500	10 1/2	2 1/2	26 3/4	90FM08501
	10	3	3500	12 1/2	2 1/2	32 1/2	90FM10501

*Tapered Roller (09) and Precision Ball (28) bearings available. Change "01" to other bearing code. Tapered Roller example: 90FM08509.

Ductile Iron V-Groove Tread (01 Roller Bearing)*

Model	Wheel Diameter	Tread Width	Capacity	Overall Height	Swivel Lead	Approx. Wt.	Base Caster Number
VM	6	2 1/2	3500	8	2 1/4	26	90VM06401
	6	3	3500	8	2 1/4	26 1/8	90VM06501
	8	3	3500	10 1/2	2 1/2	26 3/4	90VM08501
	10	3	3500	12 1/2	2 1/2	32 1/2	90VM10501

*Tapered Roller (09) and Precision Ball (28) bearings available. Change "01" to other bearing code. Tapered Roller example: 90VM08509.

90 SERIES • CAPACITY TO 3500

HEAVY DUTY KINGPIN

92

92 Heavy Duty Casters

CAPACITY TO 4800



92 Series Casters are designed specifically for power drawn trailers. These casters allow for ease of operation even on poor floor or surface conditions.

MOUNTING OPTION

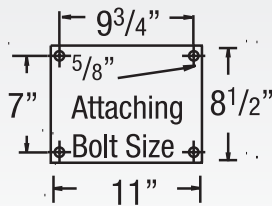

TYPICAL APPLICATIONS

- Heavy duty trash dumpsters
- Trailer frames
- Automotive plants

SWIVEL CROSS SECTION

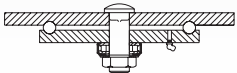

Premium Quality



Towing[^]



Environmentally Friendly

FEATURES

- **Top Plate and Yoke Base:** 5/8" thick 1045 AISI steel plate for superior strength
- **Swivel Raceways:** 7" diameter precision machined load raceway with 5/8" steel and tapered roller thrust bearing for easy swiveling
- **King Bolt:** 1" diameter bolt and nut heat treated for added strength
- **Legs:** 3/8" x 4" formed steel plate welded inside and out for maximum load capacity
- **Lubrication:** Zerk fitting in swivel section and wheel hub for ease of lubrication
- **Axle:** 3/4" hollow axle with recessed zerk for lubrication
- Alternate or custom caster configurations available

RIG OPTIONS

- **Flush King Bolt** specify **KB03**

BRAKE OPTIONS

To order, add brake code below to end of model. Example: 92PY08501SP

Poly Cam
specify **P**



Single Side specify **SSB92**. **Double Sided** specify **DSB92**

Face Contact
specify **F**



BEARING OPTIONS



Straight Roller (01)



Tapered Roller (09)



Precision Ball (28)



Wrap Around
specify **WB92**

Welded Swivel Lock
specify **L**



Hand operated field installable **Swivel Lock** order **SL920000** separately (Yokes must be notched)

	Wheel Diameter (Inches)	Tread Width (Inches)	Capacity (Lbs) (Based on manual operation)	Overall Height (Inches)	Swivel Lead (Inches)	Approx. Wt. (Lbs)	Base Caster Number+
Moldon Rubber on Cast Iron (01 Roller Bearing)							
MR	8	3	900	11	3	48	92MR08501
	10	3	1000	12 ^{7/8}	3	50 ^{1/2}	92MR10501
	10	4*	1400	12 ^{7/8}	3 ^{1/2}	63 ^{3/4}	92MR10701
	12	3	1200	14 ^{7/8}	3 ^{1/2}	56 ^{1/4}	92MR12501
	12	3 ^{1/2} *	1500	14 ^{7/8}	4	63	92MR12601
	12	4*	1600	14 ^{7/8}	4	68 ^{1/2}	92MR12701

*3-1/2" and 4" tread width model has solid axle, all others hollow axle.

	Wheel Diameter (Inches)	Tread Width (Inches)	Capacity (Lbs)	Overall Height (Inches)	Swivel Lead (Inches)	Approx. Wt. (Lbs)	Base Caster Number+
Polyurethane on Cast Iron (01 Roller Bearing)							
PY	8	3	2500	11	3	52 ^{1/2}	92PY08501
	10	3	3000	12 ^{7/8}	3	56 ^{1/2}	92PY10501
	10	4*	4200	12 ^{7/8}	3 ^{1/2}	67 ^{3/4}	92PY10701
	12	3	3500	14 ^{7/8}	3 ^{1/2}	65	92PY12501
	12	3 ^{1/2} *	4110	14 ^{7/8}	3 ^{1/2}	68 ^{3/4}	92PY12601
	12	4*	4800	14 ^{7/8}	3 ^{1/2}	71 ^{1/2}	92PY12701

*3-1/2" and 4" tread width model has solid axle, all others hollow axle.

	Wheel Diameter (Inches)	Tread Width (Inches)	Capacity (Lbs) (Based on manual operation)	Overall Height (Inches)	Swivel Lead (Inches)	Approx. Wt. (Lbs)	Base Caster Number+
Polyurethane on Cast Iron (01 Roller Bearing)							
PY 80A	8	3	2000	11	3	52 ^{1/2}	92PY0850180A
	10	3	2400	12 ^{7/8}	3	56 ^{1/2}	92PY1050180A
	10	4*	3350	12 ^{7/8}	3 ^{1/2}	67 ^{3/4}	92PY1070180A
	12	3	2800	14 ^{7/8}	3 ^{1/2}	65	92PY1250180A
	12	3 ^{1/2} *	3280	14 ^{7/8}	3 ^{1/2}	68 ^{3/4}	92PY1260180A
	12	4*	3840	14 ^{7/8}	3 ^{1/2}	71 ^{1/2}	92PY1270180A

To Specify Rigid or Swivel, insert "R" or "S" before "80A". Example: 92PY08501R80A.

*3-1/2" and 4" tread width model has solid axle, all others hollow axle.

	Wheel Diameter (Inches)	Tread Width (Inches)	Capacity (Lbs)	Overall Height (Inches)	Swivel Lead (Inches)	Approx. Wt. (Lbs)	Base Caster Number+
Vulkollan on Cast Iron (09 Tapered Roller Bearing)*							
VY	8	3	4000	11	3	52 ^{1/2}	92VY08509
	10	3	4800	12 ^{7/8}	3	56 ^{1/2}	92VY10509
	12	3	4800	14 ^{7/8}	3 ^{1/2}	65	92VY12509

* Roller (01) and Precision Ball (28) bearings available. Change "09" to other bearing code. Roller example: 92VY08501

Continue on next page >>

+ For swivel models add "S", for rigid model add "R" to end of base caster number.

Wheel Diameter (Inches)	Tread Width (Inches)	Capacity (Lbs) (Based on manual operation)	Overall Height (Inches)	Swivel Lead (Inches)	Approx. Wt. (Lbs)	Base Caster Number+
-------------------------	----------------------	--	-------------------------	----------------------	-------------------	---------------------

X-treme Plus Solid Polyurethane (28 Precision Ball Bearing)							
XP	8	3	2000	11	3	45	92XP08528
	10	3	2500	12 ⁷ / ₈	3	48	92XP10528



Polyurethane on Cast Iron (09 Tapered Roller Bearing)*							
PI	8	3	2500	11	2 ¹ / ₂	43 ³ / ₄	92PI08509
	10	3	3000	12 ⁷ / ₈	2 ¹ / ₂	49 ¹ / ₂	92PI10509
	12	3	3500	14 ⁷ / ₈	2 ¹ / ₂	60 ¹ / ₂	92PI12509

*Roller (01) bearings available. Change "01" to other bearing code. Example: 92PI06501.



Phenolic (01 Roller Bearing)							
TM	8	3	2500	11	3	43 ¹ / ₄	92TM08501
	10	3	2900	12 ⁷ / ₈	3	46 ¹ / ₄	92TM10501
	12	3	3500	14 ⁷ / ₈	3 ¹ / ₂	49 ³ / ₄	92TM12501
	12	3 ¹ / ₂ *	4000	14 ⁷ / ₈	3 ¹ / ₂	62	92TM12601

*3-1/2" and 4" tread width model has solid axle, all others hollow axle.



Trionix™ High Impact Polymer (28 Precision Ball Bearing)							
NX	8	3	4800	11	3	43 ¹ / ₄	92NX08528
	10	3	4800	12 ⁷ / ₈	3	46	92NX10528



Cast Iron (01 Roller Bearing)*							
CA	8	3	2800	11	3	48 ¹ / ₄	92CA08501
	10	3	2800	12 ⁷ / ₈	3	53 ¹ / ₄	92CA10501
	12	3	2800	14 ⁷ / ₈	3 ¹ / ₂	59	92CA12501
	12	3 ¹ / ₂ **	4000	14 ⁷ / ₈	3 ¹ / ₂	74	92CA12601

*Tapered Roller (09) bearings available. Change "01" to other bearing code. Example: 92CA08509.
**3-1/2" and 4" tread width model has solid axle, all others hollow axle.



+ For swivel models add "S", for rigid model add "R" to end of base caster number.

Wheel Diameter (Inches)	Tread Width (Inches)	Capacity (Lbs) (Based on manual operation)	Overall Height (Inches)	Swivel Lead (Inches)	Approx. Wt. (Lbs)	Base Caster Number+
-------------------------	----------------------	--	-------------------------	----------------------	-------------------	---------------------

Drop Forged Steel (01 Roller Bearing)*							
FS	8	3	4000	11	3	54 ³ / ₄	92FS08501
	10	3	4800	12 ⁷ / ₈	3	64 ¹ / ₄	92FS10501

* (09) Tapered Roller Bearings available. Change "01" to other bearing code. Example: 92FS08509.



V-grooved Cast Iron (01 Roller Bearing)							
VG	8	3	2500	11	3	53	92VG08501
	10	3	3000	12 ⁷ / ₈	3	64	92VG10501



Ductile Iron Crowned Tread (01 Roller Bearing)*							
FR	8	3	3500	11	3	49	92FR08501
	10	3	3500	12 ⁷ / ₈	3	55	92FR10501

*Tapered Roller (09) bearing available. Change "01" to other bearing code. Example: 92FR08509.



Ductile Iron Flat Tread (01 Roller Bearing)*							
FM	8	3	3500	11	3	49	92FM08501
	10	3	3500	12 ⁷ / ₈	3	55	92FM10501

*Tapered Roller (09) bearing available. Change "01" to other bearing code. Example: 92FM08509.



Ductile Iron V-Groove Tread (01 Roller Bearing)*							
VM	8	3	3500	11	3	49	92VM08501
	10	3	3500	12 ⁷ / ₈	3	55	92VM10501

*Tapered Roller (09) bearing available. Change "01" to other bearing code. Example: 92VM08509.



CUSTOM FABRICATION

This is not a one-size-fits-all business. In fact, many of our orders require custom fabrication.

If you can't find the right caster for your special application, put the Albion engineering team to work. We will create the perfect solution for your moving problem.



See pages 16-17

93

93 Heavy Duty Casters

CAPACITY TO 7500



This caster is constructed from 5/8" thick AISI 1045 steel for those rugged applications. Design accommodates wider wheels for ease of use.

TYPICAL APPLICATIONS

- Die carts
- Towed trailers
- Workstation
- Aircraft assembly

SWIVEL CROSS SECTION

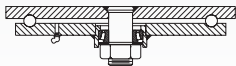

MOUNTING OPTION

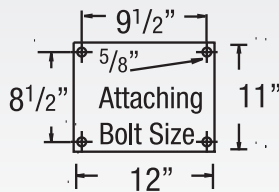

Premium Quality



Towing[^]



Environmentally Friendly

FEATURES

- **Top Plate and Yoke Base:** 5/8" thick 1045 AISI steel plate for superior strength
- **Swivel Raceways:** 7" diameter precision machined load raceway with 5/8" steel balls and a tapered roller thrust bearing for easy swiveling
- **King Bolt:** 1-1/4" diameter bolt and nut heat treated for added strength
- **Legs:** 1/2" formed steel plate welded inside and out for maximum load capacity
- **Lubrication:** Zerk fitting in swivel section and wheel hub for ease of lubrication
- **Axle:** 1-1/4" solid axle
- Alternate or custom caster configurations available

BRAKE OPTIONS

To order, add brake code below to end of model. Example: 93PY12609SP

Poly Cam
specify **P**



Face Contact
specify **F**

Welded Swivel Lock
specify **L**



BEARING OPTIONS



Straight
Roller (01)



Tapered
Roller (09)

+ For swivel models add "S", for rigid model add "R" to end of base caster number.

Wheel Diameter (Inches)	Tread Width (Inches)	Capacity (Lbs) (Roller or manual operation)	Overall Height (Inches)	Swivel Lead (Inches)	Approx. Wt. (Lbs)	Base Caster Number+
-------------------------	----------------------	---	-------------------------	----------------------	-------------------	---------------------

Vulkollan on Cast Iron (09 Tapered Roller Bearing)

Model	Wheel Diameter	Tread Width	Capacity	Overall Height	Swivel Lead	Approx. Wt.	Base Caster Number
VY	12	3 1/2	5300	15 3/4	4 1/2	93 1/2	93VY12609
	12	4	6925	15 3/4	4 1/2	96	93VY12709



Phenolic (09 Tapered Roller Bearing)

Model	Wheel Diameter	Tread Width	Capacity	Overall Height	Swivel Lead	Approx. Wt.	Base Caster Number
TM	12	3 1/2	4000	15 3/4	4 1/2	79 1/2	93TM12609
	16	3	4000	19	4 1/2	89	93TM16509
	16	4	7500	19	4 1/2	100	93TM16709



Laminated Phenolic (09 Tapered Roller Bearing)

Model	Wheel Diameter	Tread Width	Capacity	Overall Height	Swivel Lead	Approx. Wt.	Base Caster Number
TL	12	3 1/2	4000	15 3/4	4 1/2	86 1/2	93TL12609
	16	3	4000	19	4 1/2	88 3/4	93TL16509
	16	4	7500	19	4 1/2	99 1/2	93TL16709



Cast Iron (09 Tapered Roller Bearing)

Model	Wheel Diameter	Tread Width	Capacity	Overall Height	Swivel Lead	Approx. Wt.	Base Caster Number
CA	12	3 1/2	4000	15 3/4	4 1/2	98 1/2	93CA12609
	16	4	5300	19	4 1/2	129 3/4	93CA16709



Ductile Iron (01 Roller Bearing)

Model	Wheel Diameter	Tread Width	Capacity	Overall Height	Swivel Lead	Approx. Wt.	Base Caster Number
FM	12	3 1/2	6000	15 3/4	4 1/2	103 1/2	93FM12601



+ For swivel models add "S", for rigid model add "R" to end of base caster number.

Model	Wheel Diameter	Tread Width	Capacity	Overall Height	Swivel Lead	Approx. Wt.	Base Caster Number
-------	----------------	-------------	----------	----------------	-------------	-------------	--------------------

Moldon Rubber on Cast Iron (09 Tapered Roller Bearing)

Model	Wheel Diameter	Tread Width	Capacity	Overall Height	Swivel Lead	Approx. Wt.	Base Caster Number
MR	12	4	1600	15 3/4	4 1/2	92 1/2	93MR12709
	16	4	2000	19	4 1/2	111 3/4	93MR16709
	16	5	2570	19	4 1/2	125	93MR16809
	18	5	2800	21	4 1/2	149	93MR18809



Polyurethane on Cast Iron (09 Tapered Roller Bearing)

Model	Wheel Diameter	Tread Width	Capacity	Overall Height	Swivel Lead	Approx. Wt.	Base Caster Number
PY	12	3 1/2	4110	15 3/4	4 1/2	93 1/2	93PY12609
	12	4	4800	15 3/4	4 1/2	96	93PY12709
	16	3	4260	19	4 1/2	116 3/4	93PY16509
	16	4	5970	19	4 1/2	131 1/4	93PY16709
	16	5	7500	19	4 1/2	145 3/4	93PY16809
	18	5	7500	21	4 1/2	152	93PY18809



Thick Tread Polyurethane (09 Tapered Roller Bearing)

Model	Wheel Diameter	Tread Width	Capacity	Overall Height	Swivel Lead	Approx. Wt.	Base Caster Number
PX	12	4	5280	15 3/4	4 1/2	100	93PX12709
	16	3	4680	19	4 1/2	119	93PX16509
	16	4	6570	19	4 1/2	134	93PX16709
	16	5	7500	19	4 1/2	149	93PX16809



Looking for a **Heavy Duty Wheel**

that also **PROTECTS
YOUR FLOOR?**



NX
UP TO 7200 LB CAPACITY

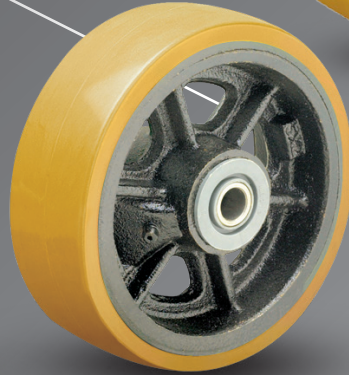

VY VULKOLLAN®
UP TO 6925 LB CAPACITY

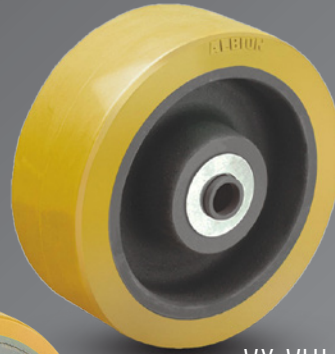

VX VULKOLLAN®
UP TO 5000 LB CAPACITY

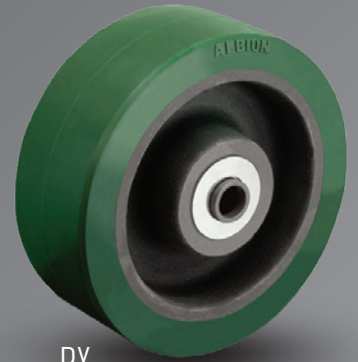

PX
UP TO 7700 LB CAPACITY

HEAVY DUTY WHEELS BY ALBION®

VY/VX VULKOLLAN®

UP TO 6925 LB CAPACITY



Highest quality polyurethane in the world. Vulkollan® wheels offer superior tear resistance, rebound resilience, dynamic load capacity, reliability, wear resistance, and structural strength. Wheels may last 40% longer than most polyurethane wheels, especially in extreme conditions.

Features:

- Hardness: 95 Shore A
- Wheel Face: Flat tread
- Finish: Orange/brown tread on cast iron core with clear coat
- Temperature Range: -40°F to +180°F

NX

UP TO 7200 LB CAPACITY



Reinforced polymer, straight sided, and higher capacity. Wheels are machined, not injection molded.

Features:

- Hardness: 78-82 Shore D
- Wheel Face: Slight radius
- Finish: Black
- Temperature Range: -30°F to +200°F

PX

UP TO 7700 LB CAPACITY



Polyurethane tread is chemically bonded to a cast iron core. High capacity polyurethane protects floors, is non-marking, and delivers quieter operations than standard metal wheels.

Features:

- Hardness: 95 Shore A
- Wheel Face: Flat or crown tread
- Finish: Green tread on black core
- Temperature Range: -40°F up to +180°F

94

94 BBL Super Duty Casters (Ball Load Swivel)

CAPACITY TO 5000



This caster has a ball load swivel (ball load swivel = "BBL") and is precision machined and heat treated to provide long life with greater capacity for that very rugged application. Made from AISI 1045 forged steel.

MOUNTING OPTIONS Standard Plate

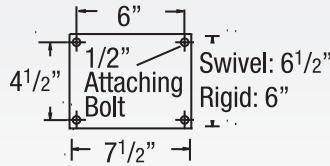

Special Order Plate Optional C Plate

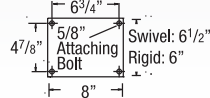

TYPICAL APPLICATIONS

- Die carts
- Towed trailers
- Automotive plants
- Aerospace industry
- Work stations
- Steel mills
- Aircraft maintenance

SWIVEL CROSS SECTION

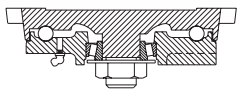

Premium Quality



Towing[^]



Environmentally Friendly

FEATURES

- **Top Plate and Yoke Base:** 1/2" thick AISI 1045 drop forged steel
- **Swivel Load:** 5" diameter ball load race with 1/2" steel balls hardened for greater resistance to wear and brinelling. Protected by a forged labyrinth skirt
- **Thrust Race:** 1-1/4" tapered roller bearing
- **Legs:** 3/8" formed steel plate welded inside and out to yoke base and rigid top
- **King Bolt:** 1-1/4" diameter integrally forged with top plate for maximum strength
- **Axle:** 1" solid axle with lock nut
- **Lubrication:** Zerk fitting in yoke base and wheel hubs for easy lubrication
- Alternate or custom caster configurations available

RIG OPTIONS

- **Sealed swivel** section specify **NS94**

BRAKE OPTIONS

To order, add brake code below to end of model. Example: 94PY06409SBBLP

Poly Cam
specify **P**



Single Side specify **SSB94**. **Double Sided** specify **DSB94**

Face Contact
specify **F**



Wrap Around
specify **WB94**

Welded Swivel Lock
specify **L**



Hand operated field installable **Swivel Lock** order **SL940000** separately (Yokes must be notched)

BEARING OPTIONS

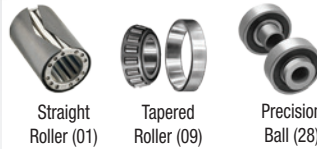

Straight Roller (01)

Tapered Roller (09)

Precision Ball (28)

+ For Rigid models change "SBBL" to "RBBL" to end of base caster number.

Wheel Diameter (Inches)	Tread Width (Inches)	Capacity (Lbs) (Rigid or manual operation)	Overall Height (Inches)	Swivel Lead (Inches)	Approx. Wt. (Lbs)	Caster Number+
-------------------------	----------------------	--	-------------------------	----------------------	-------------------	----------------

Polyurethane on Cast Iron (09 Tapered Roller Bearing)

PY	6	2 1/2	1600	8 1/2	2 1/2	36	94PY06409SBBL
	6	3	2000	8 1/2	2 1/2	37 1/4	94PY06509SBBL
	8	3	2500	10 1/2	2 1/2	41	94PY08509SBBL
	8	4	3800	10 1/2	2 1/2	48	94PY08709SBBL
	10	3	3000	12 1/2	2 1/2	45 1/2	94PY10509SBBL
	10	4	4200	12 1/2	2 1/2	55	94PY10709SBBL
	12	3 1/2	4110	15 1/2	2 1/2	57 1/2	94PY12609SBBL
	12	4	4800	15 1/2	2 1/2	60	94PY12709SBBL

Polyurethane 80A on Cast Iron (09 Tapered Roller Bearing)

PY 80A	6	2 1/2	1300	8 1/2	2 1/2	36	94PY06409SBBL80A
	6	3	1600	8 1/2	2 1/2	37 1/4	94PY06509SBBL80A
	8	3	2000	10 1/2	2 1/2	41	94PY08509SBBL80A
	8	4	3000	10 1/2	2 1/2	48	94PY08709SBBL80A
	10	3	2400	12 1/2	2 1/2	45 1/2	94PY10509SBBL80A
	10	4	3350	12 1/2	2 1/2	55	94PY10709SBBL80A
	12	3 1/2	3280	15 1/2	2 1/2	57 1/2	94PY12609SBBL80A
	12	4	3840	15 1/2	2 1/2	60	94PY12709SBBL80A

To Specify Rigid, insert "R" before "80A".

Ex: 94PY06409SBBLR80A.

+ For Rigid models change "SBBL" to "RBBL" to end of base caster number.

Moldon Rubber on Cast Iron (09 Tapered Roller Bearing)

MR	8	3	900	10 1/2	2 1/2	36 3/4	94MR08509SBBL
	10 <td>3 <td>1000 <td>12 1/2 <td>2 1/2 <td>39 3/4 <th>94MR10509SBBL</th> </td></td></td></td></td>	3 <td>1000 <td>12 1/2 <td>2 1/2 <td>39 3/4 <th>94MR10509SBBL</th> </td></td></td></td>	1000 <td>12 1/2 <td>2 1/2 <td>39 3/4 <th>94MR10509SBBL</th> </td></td></td>	12 1/2 <td>2 1/2 <td>39 3/4 <th>94MR10509SBBL</th> </td></td>	2 1/2 <td>39 3/4 <th>94MR10509SBBL</th> </td>	39 3/4 <th>94MR10509SBBL</th>	94MR10509SBBL
	10 <td>3* <td>1800 <td>12 1/2 <td>2 1/2 <td>39 3/4 <th>94MR10509SBBL</th> </td></td></td></td></td>	3* <td>1800 <td>12 1/2 <td>2 1/2 <td>39 3/4 <th>94MR10509SBBL</th> </td></td></td></td>	1800 <td>12 1/2 <td>2 1/2 <td>39 3/4 <th>94MR10509SBBL</th> </td></td></td>	12 1/2 <td>2 1/2 <td>39 3/4 <th>94MR10509SBBL</th> </td></td>	2 1/2 <td>39 3/4 <th>94MR10509SBBL</th> </td>	39 3/4 <th>94MR10509SBBL</th>	94MR10509SBBL
	10 <td>4 <td>1400 <td>12 1/2 <td>2 1/2 <td>50 3/4 <th>94MR10709SBBL</th> </td></td></td></td></td>	4 <td>1400 <td>12 1/2 <td>2 1/2 <td>50 3/4 <th>94MR10709SBBL</th> </td></td></td></td>	1400 <td>12 1/2 <td>2 1/2 <td>50 3/4 <th>94MR10709SBBL</th> </td></td></td>	12 1/2 <td>2 1/2 <td>50 3/4 <th>94MR10709SBBL</th> </td></td>	2 1/2 <td>50 3/4 <th>94MR10709SBBL</th> </td>	50 3/4 <th>94MR10709SBBL</th>	94MR10709SBBL
	12 <td>3 1/2 <td>1500 <td>15 1/2 <td>2 1/2 <td>55 3/4 <th>94MR12609SBBL</th> </td></td></td></td></td>	3 1/2 <td>1500 <td>15 1/2 <td>2 1/2 <td>55 3/4 <th>94MR12609SBBL</th> </td></td></td></td>	1500 <td>15 1/2 <td>2 1/2 <td>55 3/4 <th>94MR12609SBBL</th> </td></td></td>	15 1/2 <td>2 1/2 <td>55 3/4 <th>94MR12609SBBL</th> </td></td>	2 1/2 <td>55 3/4 <th>94MR12609SBBL</th> </td>	55 3/4 <th>94MR12609SBBL</th>	94MR12609SBBL
	12 <td>4 <td>1600 <td>15 1/2 <td>2 1/2 <td>63 1/4 <th>94MR12709SBBL</th> </td></td></td></td></td>	4 <td>1600 <td>15 1/2 <td>2 1/2 <td>63 1/4 <th>94MR12709SBBL</th> </td></td></td></td>	1600 <td>15 1/2 <td>2 1/2 <td>63 1/4 <th>94MR12709SBBL</th> </td></td></td>	15 1/2 <td>2 1/2 <td>63 1/4 <th>94MR12709SBBL</th> </td></td>	2 1/2 <td>63 1/4 <th>94MR12709SBBL</th> </td>	63 1/4 <th>94MR12709SBBL</th>	94MR12709SBBL

*Heavy-duty MH version of 10x3 wheel.

Continue on next page >>

+ For Rigid models change "SBBL" to "RBBL" to end of base caster number.

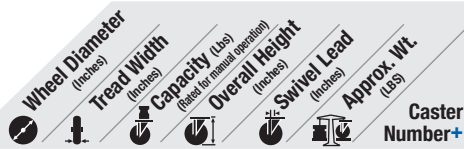

Polyurethane on Cast Iron (09 Tapered Roller Bearing)*							
PI	Wheel Diameter (Inches)	Tread Width (Inches)	Capacity (Lbs) (Rated for manual operation)	Overall Height (Inches)	Swivel Lead (Inches)	Approx. Wt. (Lbs)	Caster Number+
	6	2 1/2	1600	8 1/2	2 1/2	34	94PI06409SBBL
	6	3	2000	8 1/2	2 1/2	35 1/2	94PI06509SBBL
	8	2 1/2	2000	10 1/2	2 1/2	34 1/2	94PI08409SBBL
	8	3	2500	10 1/2	2 1/2	35 1/2	94PI08509SBBL
	10	2 1/2	2200	12 1/2	2 1/2	41	94PI10409SBBL
	10	3	3000	12 1/2	2 1/2	42 1/2	94PI10509SBBL
	12	2 1/2	2500	15 1/2	2 1/2	51 1/2	94PI12409SBBL
	12	3	3500	15 1/2	2 1/2	53	94PI12509SBBL

*Roller (01) bearings available. Change "01" to other bearing code.
Example: 94PI06401SBBL.

Polyurethane on Aluminum (09 Tapered Roller Bearing)*							
PD	Wheel Diameter (Inches)	Tread Width (Inches)	Capacity (Lbs) (Rated for manual operation)	Overall Height (Inches)	Swivel Lead (Inches)	Approx. Wt. (Lbs)	Caster Number+
	8	3	2520	10 1/2	2 1/2	37	94PD08509SBBL
	10	3	3000	12 1/2	2 1/2	39 1/2	94PD10509SBBL

*Roller (01) bearings available. Change "09" to other bearing code.
Roller example: 92PD08501SBBL.

Thick Tread Polyurethane (09 Tapered Roller Bearing)							
PX	Wheel Diameter (Inches)	Tread Width (Inches)	Capacity (Lbs) (Rated for manual operation)	Overall Height (Inches)	Swivel Lead (Inches)	Approx. Wt. (Lbs)	Caster Number+
	6	3	2250	8 1/2	2 1/2	37 1/4	94PX06509SBBL
	8	3	2780	10 1/2	2 1/2	41 1/2	94PX08509SBBL
	8	4	3850	10 1/2	2 1/2	48	94PX08709SBBL
	10	3	3300	12 1/2	2 1/2	46	94PX10509SBBL
	10	4	4620	12 1/2	2 1/2	55	94PX10709SBBL
	12	4	5000	15 1/2	2 1/2	60	94PX12709SBBL

Vulkollan on Cast Iron (09 Tapered Bearing)*							
VY	Wheel Diameter (Inches)	Tread Width (Inches)	Capacity (Lbs) (Rated for manual operation)	Overall Height (Inches)	Swivel Lead (Inches)	Approx. Wt. (Lbs)	Caster Number+
	6	2 1/2	2350	8 1/2	2 1/2	36	94VY06409SBBL
	6	3	3000	8 1/2	2 1/2	37 1/4	94VY06509SBBL
	8	3	4000	10 1/2	2 1/2	41	94VY08509SBBL
	10	3	5000	12 1/2	2 1/2	45 1/2	94VY10509SBBL

*Roller (01) and Precision Ball (28) bearings available. Change "09" to other bearing code. Precision Ball example: 94VY06428SBBL.

Thick Tread Vulkollan (09 Roller Bearing)*							
VX	Wheel Diameter (Inches)	Tread Width (Inches)	Capacity (Lbs) (Rated for manual operation)	Overall Height (Inches)	Swivel Lead (Inches)	Approx. Wt. (Lbs)	Caster Number+
	6	3	3000	8 1/2	2 1/2	37 1/4	94VX06509SBBL
	8	3	4000	10 1/2	2 1/2	41 1/2	94VX08509SBBL
	10	3	5000	12 1/2	2 1/2	46	94VX10509SBBL

*Roller (01) and Precision Ball (28) bearings available. Change "09" to other bearing code. Precision Ball example: 94VX06428SBBL.

Trionix™ High Impact Polymer (28 Precision Ball Bearing)							
NX	Wheel Diameter (Inches)	Tread Width (Inches)	Capacity (Lbs) (Rated for manual operation)	Overall Height (Inches)	Swivel Lead (Inches)	Approx. Wt. (Lbs)	Caster Number+
	6	2 1/2	5000	8 1/2	2 1/2	36	94NX06428SBBL
	6	3	5000	8 1/2	2 1/2	37 1/4	94NX06528SBBL
	8	3	5000	10 1/2	2 1/2	41	94NX08528SBBL
	10	3	5000	12 1/2	2 1/2	45 1/2	94NX10528SBBL

Phenolic (09 Tapered Roller Bearing)							
TM	Wheel Diameter (Inches)	Tread Width (Inches)	Capacity (Lbs) (Rated for manual operation)	Overall Height (Inches)	Swivel Lead (Inches)	Approx. Wt. (Lbs)	Caster Number+
	6	2 1/2	1620	8 1/2	2 1/2	32 1/4	94TM06409SBBL
	8	3	2500	10 1/2	2 1/2	38	94TM08509SBBL
	10	2 1/2	2500	12 1/2	2 1/2	46	94TM10409SBBL
	10	3	2900	12 1/2	2 1/2	49	94TM10509SBBL
	12	3 1/2	4000	15 1/2	2 1/2	52 3/4	94TM12609SBBL
	12	4	5000	15 1/2	2 1/2		94TM12709SBBL

+ For Rigid models change "SBBL" to "RBBL" to end of base caster number.

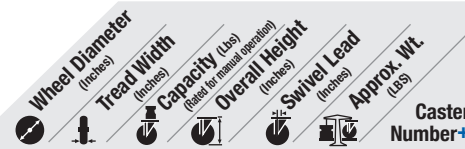

Laminated Phenolic (09 Tapered Roller Bearing)							
TL	Wheel Diameter (Inches)	Tread Width (Inches)	Capacity (Lbs) (Rated for manual operation)	Overall Height (Inches)	Swivel Lead (Inches)	Approx. Wt. (Lbs)	Caster Number+
	6	3	2000	8 1/2	2 1/2	29 1/2	94TL06509SBBL
	8	3	2500	10 1/2	2 1/2	32 1/4	94TL08509SBBL
	10	3	3000	12 1/2	2 1/2	46	94TL10509SBBL
	12	3 1/2	4000	15 1/2	2 1/2	49 3/4	94TL12609SBBL

Cast Iron (09 Tapered Roller Bearing)							
CA	Wheel Diameter (Inches)	Tread Width (Inches)	Capacity (Lbs) (Rated for manual operation)	Overall Height (Inches)	Swivel Lead (Inches)	Approx. Wt. (Lbs)	Caster Number+
	6	3	2800	8 1/2	2 1/2	38 1/2	94CA06509SBBL
	8	3	2800	10 1/2	2 1/2	38 1/2	94CA08509SBBL
	8	4	4000	10 1/2	2 1/2	52 1/2	94CA08709SBBL
	10	3	2800	12 1/2	2 1/2	43 1/2	94CA10509SBBL
	12	3	2800	15 1/2	2 1/2	49 1/2	94CA12509SBBL
	12	3 1/2	4000	15 1/2	2 1/2	63	94CA12609SBBL

Drop Forged Steel (09 Tapered Roller Bearing)							
FS	Wheel Diameter (Inches)	Tread Width (Inches)	Capacity (Lbs) (Rated for manual operation)	Overall Height (Inches)	Swivel Lead (Inches)	Approx. Wt. (Lbs)	Caster Number+
	6	2 1/2	4000	8 1/2	2 1/2	37	94FS06409SBBL
	6	3	5000	8 1/2	2 1/2	45	94FS06509SBBL
	8	3	4500	10 1/2	2 1/2	44	94FS08509SBBL
	8	4	5000	10 1/2	2 1/2	47	94FS08709SBBL
	10	3	5000	12 1/2	2 1/2	53 3/4	94FS10509SBBL
	10	4	5000	12 1/2	2 1/2	73 1/2	94FS10709SBBL

Ductile Iron Crowned Tread (09 Tapered Roller Bearing)*							
FR	Wheel Diameter (Inches)	Tread Width (Inches)	Capacity (Lbs) (Rated for manual operation)	Overall Height (Inches)	Swivel Lead (Inches)	Approx. Wt. (Lbs)	Caster Number+
	6	2 1/2	3500	8 1/2	2 1/2	34	94FR06409SBBL
	6	3	5000	8 1/2	2 1/2	35	94FR06509SBBL
	8	3	5000	10 1/2	2 1/2	41	94FR08509SBBL
	10	3	5000	12 1/2	2 1/2	46	94FR10509SBBL

*Roller (01) and Precision Ball (28) bearings available. Change "09" to other bearing code. Roller example: 94FR08501SBBL.

Ductile Iron Flat Tread (09 Tapered Roller Bearing)*							
FM	Wheel Diameter (Inches)	Tread Width (Inches)	Capacity (Lbs) (Rated for manual operation)	Overall Height (Inches)	Swivel Lead (Inches)	Approx. Wt. (Lbs)	Caster Number+
	6	2 1/2	3500	8 1/2	2 1/2	34	94FM06409SBBL
	6	3	5000	8 1/2	2 1/2	35	94FM06509SBBL
	8	3	5000	10 1/2	2 1/2	41	94FM08509SBBL
	10	3	5000	12 1/2	2 1/2	46	94FM10509SBBL
	12	3 1/2	5000	15 1/2	2 1/2	67 1/2	94FM12609SBBL

*Roller (01) and Precision Ball (28) available. Change "09" to other bearing code. Straight Roller example: 94FM08501BBL.

Ductile Iron V-Groove Tread (09 Tapered Roller Bearing)*							
VM	Wheel Diameter (Inches)	Tread Width (Inches)	Capacity (Lbs) (Rated for manual operation)	Overall Height (Inches)	Swivel Lead (Inches)	Approx. Wt. (Lbs)	Caster Number+
	6	2 1/2	3500	8 1/2	2 1/2	34	94VM06409SBBL
	6	3	5000	8 1/2	2 1/2	35	94VM06509SBBL
	8	3	5000	10 1/2	2 1/2	41	94VM08509SBBL
	10	3	5000	12 1/2	2 1/2	46	94VM10509SBBL

*Roller (01) and Precision Ball (28) bearings available. Change "09" to other bearing code. Roller example: 94VM08501SBBL.

94

94 TRL Super Duty Casters (Tapered Thrust Swivel Section)

CAPACITY TO 10000



This caster has a precision roller bearing load and thrust swivel section (thrust swivel section = "TRL") and is precision machined to provide long life with greater capacity for that very rugged application. Made from AISI 1045 drop forged steel.

MOUNTING OPTIONS Standard Plate

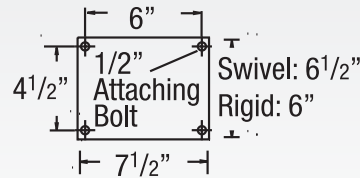

Special Order Plate Optional C Plate

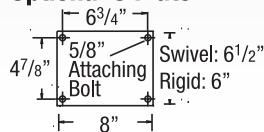

TYPICAL APPLICATIONS

- Die carts
- Towed trailers
- Automotive plants
- Aerospace industry
- Work stations
- Steel mills
- Aircraft maintenance
- Gantries

SWIVEL CROSS SECTION

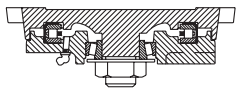

Premium Quality



Towing[^]



Environmentally Friendly

FEATURES

- **Top Plate and Yoke Base:** 1/2" thick AISI 1045 drop forged steel
- **Swivel Load Race:** Precision tapered roller bearing which has 5" outside diameter for increased capacity
- **Thrust Bearing:** 1-1/4" tapered roller bearing
- **Legs:** 3/8" formed steel plate welded inside and outside for additional strength
- **King Bolt:** 1-1/4" diameter integrally forged with top plate for maximum strength
- **Axle:** 1" solid axle with lock nut
- **Lubrication:** Zerk fitting in yoke base and wheel hubs for ease of lubrication
- Alternate or custom caster configurations available

RIG OPTIONS

- Spring-loaded, dual wheel models available, consult factory
- **Sealed swivel section** specify **NS94**

BRAKE OPTIONS

To order, add brake code below to end of model. Example: 94PY06509STRLP

Poly Cam specify **P**



Single Side specify **SSB94**. **Double Sided** specify **DSB94**

Face Contact specify **F**



BEARING OPTIONS

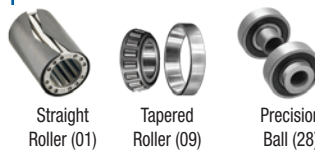

Wrap Around specify **WB94**

Hand operated field installable **Swivel Lock** order **SL940000** separately (Yokes must be notched)



Welded Swivel Lock specify **L**

	Wheel Diameter (Inches)	Tread Width (Inches)	Capacity (Lbs) (Rigid or manual operation)	Overall Height (Inches)	Swivel Lead (Inches)	Approx. Wt. (Lbs)	Caster Number+
--	-------------------------	----------------------	--	-------------------------	----------------------	-------------------	----------------

Moldon Rubber on Cast Iron (09 Tapered Roller Bearing)							
MR	8	3	900	10 1/2	2 1/2	36 3/4	94MR08509STR
	10	3	1000	12 1/2	2 1/2	39 3/4	94MR10509STR
	10	4	1400	12 1/2	2 1/2	50 3/4	94MR10709STR
	12	3 1/2	1500	15 1/2	2 1/2	55 3/4	94MR12609STR
	12	4	1600	15 1/2	2 1/2	63 1/4	94MR12709STR

Heavy Duty Moldon Rubber on Cast Iron (09 Tapered Bearing)							
MH	10	3	1800	12 1/2	2 1/2	39 3/4	94MH10509STR

+ For Rigid models change "STRL" to "RTRL" to end of base caster number.

Polyurethane on Cast Iron (09 Tapered Roller Bearing)							
PY	6	3	2000	8 1/2	2 1/2	37 1/4	94PY06509STR
	8	3	2500	10 1/2	2 1/2	41	94PY08509STR
	8	4	3800	10 1/2	2 1/2	48	94PY08709STR
	10	3	3000	12 1/2	2 1/2	45 1/2	94PY10509STR
	10	4	4200	12 1/2	2 1/2	55	94PY10709STR
	12	3 1/2	4110	15 1/2	2 1/2	57 1/2	94PY12609STR
	12	4	4800	15 1/2	2 1/2	60	94PY12709STR

Polyurethane on Cast Iron (09 Tapered Roller Bearing)							
PY 80A	6	3	1600	8 1/2	2 1/2	37 1/4	94PY06509STR80A
	8	3	2000	10 1/2	2 1/2	41	94PY08509STR80A
	8	4	3000	10 1/2	2 1/2	48	94PY08709STR80A
	10	3	2400	12 1/2	2 1/2	45 1/2	94PY10509STR80A
	10	4	3550	12 1/2	2 1/2	55	94PY10709STR80A
	12	3 1/2	2160	15 1/2	2 1/2	57 1/2	94PY12609STR80A
	12	4	3840	15 1/2	2 1/2	60	94PY12709STR80A

To Specify Rigid or Swivel, insert "R" or "S" before "80A".
Ex: 94PY06509STR^R80A.

Continue on next page >>

+ For Rigid models change "STRL" to "RTRL" to end of base caster number.

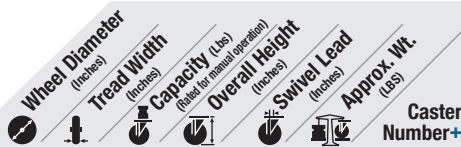

Polyurethane on Cast Iron (09 Tapered Roller Bearing)*

PI	Wheel Diameter (inches)	Tread Width (inches)	Capacity (lbs) (rated for manual operation)	Overall Height (inches)	Swivel Lead (inches)	Approx. Wt. (lbs)	Caster Number+
	6	2 1/2	1600	8 1/2	2 1/2	34	94PI06409STRL
	6	3	2000	8 1/2	2 1/2	35 1/2	94PI06509STRL
	8	2 1/2	2000	10 1/2	2 1/2	34 1/2	94PI08409STRL
	8	3	2500	10 1/2	2 1/2	35 1/2	94PI08509STRL
	10	2 1/2	2200	12 1/2	2 1/2	41	94PI10409STRL
	10	3	3000	12 1/2	2 1/2	42 1/2	94PI10509STRL
	12	2 1/2	2500	15 1/2	2 1/2	51 1/2	94PI12409STRL
	12	3	3500	15 1/2	2 1/2	53	94PI12509STRL

*Roller (01) bearings available. Change "01" to other bearing code. Example: 94PI06401STRL.

Polyurethane on Aluminum (09 Tapered Roller Bearing)*

PD	Wheel Diameter (inches)	Tread Width (inches)	Capacity (lbs) (rated for manual operation)	Overall Height (inches)	Swivel Lead (inches)	Approx. Wt. (lbs)	Caster Number+
	8	3	2520	10 1/2	2 1/2	41	94PD08509STRL
	10	3	3000	12 1/2	2 1/2	45 1/2	94PD10509STRL

*Roller (01) bearings available. Change "09" to other bearing code. Roller example: 94PD08501STRL.

Thick Tread Polyurethane (09 Tapered Roller Bearing)

PX	Wheel Diameter (inches)	Tread Width (inches)	Capacity (lbs) (rated for manual operation)	Overall Height (inches)	Swivel Lead (inches)	Approx. Wt. (lbs)	Caster Number+
	6	3	2250	8 1/2	2 1/2	37 1/4	94PX06509STRL
	8	3	2780	10 1/2	2 1/2	41 1/2	94PX08509STRL
	8	4	3850	10 1/2	2 1/2	48	94PX08709STRL
	10	3	3300	12 1/2	2 1/2	46	94PX10509STRL
	10	4	4620	12 1/2	2 1/2	55	94PX10709STRL
	12	4	5280	15 1/2	2 1/2	60	94PX12709STRL

Vulkollan on Cast Iron (09 Tapered Roller Bearing)*

VY	Wheel Diameter (inches)	Tread Width (inches)	Capacity (lbs) (rated for manual operation)	Overall Height (inches)	Swivel Lead (inches)	Approx. Wt. (lbs)	Caster Number+
	6	3	3000	8 1/2	2 1/2	37 1/4	94VY06509STRL
	8	3	4000	10 1/2	2 1/2	41	94VY08509STRL
	10	3	5000	12 1/2	2 1/2	45 1/2	94VY10509STRL

*Roller (01) and Precision Ball (28) bearings available. Change "01" to other bearing code. Precision example: 94VY06528STRL.

Thick Tread Vulkollan (09 Tapered Roller Bearing)*

VX	Wheel Diameter (inches)	Tread Width (inches)	Capacity (lbs) (rated for manual operation)	Overall Height (inches)	Swivel Lead (inches)	Approx. Wt. (lbs)	Caster Number+
	6	3	3000	8 1/2	2 1/2	37 1/4	94VX06509STRL
	8	3	4000	10 1/2	2 1/2	41 1/2	94VX08509STRL
	10	3	5000	12 1/2	2 1/2	46	94VX10509STRL

*Roller (01) and Precision Ball (28) bearings available. Change "09" to other bearing code. Precision Ball bearing example: 94VX06528STRL.

Trionix™ High Impact Polymer (28 Precision Ball Bearing)

NX	Wheel Diameter (inches)	Tread Width (inches)	Capacity (lbs) (rated for manual operation)	Overall Height (inches)	Swivel Lead (inches)	Approx. Wt. (lbs)	Caster Number+
	6	2 1/2	7100	8 1/2	2 1/2	36	94NX06428STRL
	6	3	7100	8 1/2	2 1/2	37 1/4	94NX06528STRL
	8	3	7100	10 1/2	2 1/2	41	94NX08528STRL
	10	3	7100	12 1/2	2 1/2	45 1/2	94NX10528STRL

Phenolic (09 Tapered Roller Bearing)

TM	Wheel Diameter (inches)	Tread Width (inches)	Capacity (lbs) (rated for manual operation)	Overall Height (inches)	Swivel Lead (inches)	Approx. Wt. (lbs)	Caster Number+
	6	2 1/2	2000	8 1/2	2 1/2	32 1/4	94TM06409STRL
	8	3	2500	10 1/2	2 1/2	38	94TM08509STRL
	10	3	2900	12 1/2	2 1/2	49	94TM10509STRL
	12	3 1/2	4000	15 1/2	2 1/2	49 3/4	94TM12609STRL
	12	4	8000	15 1/2	2 1/2	52 1/4	94TM12709STRL

Laminated Phenolic (09 Tapered Roller Bearing)

TL	Wheel Diameter (inches)	Tread Width (inches)	Capacity (lbs) (rated for manual operation)	Overall Height (inches)	Swivel Lead (inches)	Approx. Wt. (lbs)	Caster Number+
	6	3	2000	8 1/2	2 1/2	29 1/2	94TL06509STRL
	8	3	2500	10 1/2	2 1/2	32 1/4	94TL08509STRL
	10	3	3000	12 1/2	2 1/2	46	94TL10509STRL
	12	3 1/2	4000	15 1/2	2 1/2	49 3/4	94TL12609STRL

+ For Rigid models change "STRL" to "RTRL" to end of base caster number.

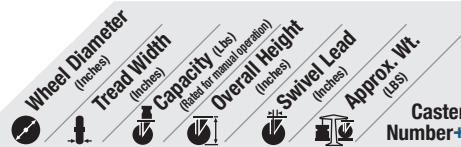

Cast Iron (09 Tapered Roller Bearing)

CA	Wheel Diameter (inches)	Tread Width (inches)	Capacity (lbs) (rated for manual operation)	Overall Height (inches)	Swivel Lead (inches)	Approx. Wt. (lbs)	Caster Number+
	6	3	2800	8 1/2	2 1/2	38 1/2	94CA06509STRL
	8	3	2800	10 1/2	2 1/2	38 1/2	94CA08509STRL
	8	4	6000	10 1/2	2 1/2	52 1/2	94CA08709STRL
	10	3	2800	12 1/2	2 1/2	43 1/2	94CA10509STRL
	12	3	2800	15 1/2	2 1/2	49 1/2	94CA12509STRL

Drop Forged Steel (01 Roller or 09 Tapered Roller Bearing)

FS	Wheel Diameter (inches)	Tread Width (inches)	Capacity (lbs) (rated for manual operation)	Overall Height (inches)	Swivel Lead (inches)	Approx. Wt. (lbs)	Caster Number+
	6	2 1/2	4000	8 1/2	2 1/2	37	94FS06401STRL
	6	2 1/2	5000	8 1/2	2 1/2	37	94FS06409STRL
	6	3	6000	8 1/2	2 1/2	45	94FS06501STRL
	6	3	10000	8 1/2	2 1/2	45	94FS06509STRL
	8	3	4500	10 1/2	2 1/2	44	94FS08501STRL
	8	3	5500	10 1/2	2 1/2	44	94FS08509STRL
	8	4	8350	10 1/2	2 1/2	47	94FS08701STRL
	8	4	10000	10 1/2	2 1/2	47	94FS08709STRL
	10	3	5000	12 1/2	2 1/2	53 3/4	94FS10501STRL
	10	3	6000	12 1/2	2 1/2	53 3/4	94FS10509STRL
	10	4	8350	12 1/2	2 1/2	73 1/2	94FS10701STRL
	10	4	10000	12 1/2	2 1/2	73 1/2	94FS10709STRL

V-Grooved Cast Iron (09 Tapered Roller Bearing)

VL	Wheel Diameter (inches)	Tread Width (inches)	Capacity (lbs) (rated for manual operation)	Overall Height (inches)	Swivel Lead (inches)	Approx. Wt. (lbs)	Caster Number+
	8	3	4000	10 1/2	2 1/2	42 3/4	94VL08509STRL
	10	3	4000	12 1/2	2 1/2	35 3/4	94VL10509STRL

V-Grooved Drop Forged Steel (01 Roller or 09 Tapered Roller)

VF	Wheel Diameter (inches)	Tread Width (inches)	Capacity (lbs) (rated for manual operation)	Overall Height (inches)	Swivel Lead (inches)	Approx. Wt. (lbs)	Caster Number+
	6	3	6000	8 1/2	2 1/2	45	94VF06501STRL
	6	3	6500	8 1/2	2 1/2	45	94VF06509STRL
	8	3	6000	10 1/2	2 1/2	44	94VF08501STRL
	8	4	8350	10 1/2	2 1/2	47	94VF08701STRL
	8	4	10000	10 1/2	2 1/2	47	94VF08709STRL
	10	4	8350	12 1/2	2 1/2	73 1/2	94VF10701STRL
	10	4	10000	12 1/2	2 1/2	73 1/2	94VF10709STRL

Ductile Iron Crowned Tread (01 Roller Bearing)*

FR	Wheel Diameter (inches)	Tread Width (inches)	Capacity (lbs) (rated for manual operation)	Overall Height (inches)	Swivel Lead (inches)	Approx. Wt. (lbs)	Caster Number+
	6	2 1/2	3500	8 1/2	2 1/2	34	94FR06409STRL
	6	3	6000	8 1/2	2 1/2	35	94FR06509STRL
	8	3	6000	10 1/2	2 1/2	41	94FR08509STRL
	10	3	6000	12 1/2	2 1/2	46	94FR10509STRL

*Roller (01) and Precision Ball (28) bearings available. Change "09" to other bearing code. Roller example: 94FR08501STRL.

Ductile Iron Flat Tread (09 Tapered Roller Bearing)*

FM	Wheel Diameter (inches)	Tread Width (inches)	Capacity (lbs) (rated for manual operation)	Overall Height (inches)	Swivel Lead (inches)	Approx. Wt. (lbs)	Caster Number+
	6	2 1/2	3500	8 1/2	2 1/2	34	94FM06409STRL
	6	3	6000	8 1/2	2 1/2	35	94FM06509STRL
	8	3	6000	10 1/2	2 1/2	41	94FM08509STRL
	10	3	6000	12 1/2	2 1/2	46	94FM10509STRL
	12	3 1/2	6000	15 1/2	2 1/2	67 1/2	94FM12609STRL

*Roller (01) and Precision Ball (28) bearings available. Change "09" to other bearing code. Roller example: 94FM08501STRL.

Ductile Iron V-Groove Tread (09 Tapered Roller Bearing)

VM	Wheel Diameter (inches)	Tread Width (inches)	Capacity (lbs) (rated for manual operation)	Overall Height (inches)	Swivel Lead (inches)	Approx. Wt. (lbs)	Caster Number+
	6	2 1/2	3500	8 1/2	2 1/2	34	94VM06409STRL
	6	3	6000	8 1/2	2 1/2	35	94VM06509STRL
	8	3	6000	10 1/2	2 1/2	41	94VM08509STRL
	10	3	6000	12 1/2	2 1/2	46	94VM10509STRL

*Roller (01) and Precision Ball (28) bearings available. Change "09" to other bearing code. Roller example: 94VM08501STRL.

95

95 BBL Super Duty Casters (Ball Load Swivel)

CAPACITY TO 8000



This popular caster series has a ball load swivel (ball load swivel = "BBL") and is precision machined and heat treated to provide long life with greater capacity for that very rugged application. Made from AISI 1045 forged steel.

TYPICAL APPLICATIONS

- Die carts
- Towed trailers
- Automotive plants
- Aerospace industry
- Work stations
- Steel mills
- Aircraft maintenance

SWIVEL CROSS SECTION

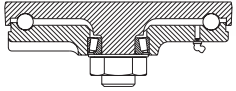

+ For Rigid models change "SBBL" to "RBBL" to end of base caster number.

MOUNTING OPTIONS Standard Plate

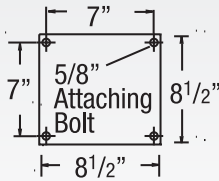

Special Order Plate Optional T Plate

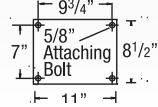

Wheel Diameter (Inches)	Tread Width (Inches)	Capacity (Lbs) (Rate for manual operation)	Overall Height (Inches)	Swivel Lead (Inches)	Approx. Wt. (Lbs)	Caster Number+
-------------------------	----------------------	--	-------------------------	----------------------	-------------------	----------------

Moldon Rubber on Cast Iron (01 Roller Bearing)

MR	Wheel Diameter	Tread Width	Capacity	Overall Height	Swivel Lead	Approx. Wt.	Caster Number
	10	4	1400	13	2 1/2	64 3/4	95MR10701SBBL
	12	4	1600	15 1/2	2 1/2	55 3/4	95MR12701SBBL
	16	5	2570	19	3	105 1/4	95MR16801SBBL

Polyurethane on Cast Iron (09 Tapered Roller Bearing)*

PY	Wheel Diameter	Tread Width	Capacity	Overall Height	Swivel Lead	Approx. Wt.	Caster Number
	10	4	4200	13	2 1/2	71	95PY10709SBBL
	10	5	5000	13	2 1/2	82	95PY10809SBBL
	12	3 1/2	4110	15 1/2	2 1/2	73 1/2	95PY12609SBBL
	12	4	4800	15 1/2	2 1/2	76 1/4	95PY12709SBBL
	12	5	6000	15 1/2	2 1/2	90	95PY12809SBBL
	16	4	5970	19	3	111 1/2	95PY16709SBBL
	16	5	7700	19	3	126 1/4	95PY16809SBBL

*Roller Bearings (01) available. To order change bearing code. Example 95PY08701SBBL.

Trionix™ High Impact Polymer (28 Precision Ball Bearing)

NX	Wheel Diameter	Tread Width	Capacity	Overall Height	Swivel Lead	Approx. Wt.	Caster Number
	6	2 1/2	7200	9	2 1/4	36	95NX06428SBBL
	6	3	7200	9	2 1/4	37 1/4	95NX06528SBBL
	8	2 1/2	7200	11	2 1/4	41	95NX08428SBBL
	8	3	7200	11	2 1/4	41	95NX08528SBBL
	10	2 1/2	7200	13	2 1/2	45 1/2	95NX10428SBBL
	10	3	7200	13	2 1/2	45 1/2	95NX10528SBBL

FEATURES

- **Top Plate and Yoke Base:** 5/8" thick 1045 AISI drop-forged steel for extended use
- **Swivel Load Bearings:** 7" diameter machined and hardened raceway for smooth movement and extended wear
- **Component Thrust Bearing:** 1-1/4" tapered roller bearing
- **Legs:** 1/2" formed steel plate welded inside and out to yoke base
- **King Bolt:** Integrally forged with top plate
- **Axle:** 1-1/4" solid axle with locking nut
- Alternate or custom caster configurations available

RIG OPTIONS

- **Sealed swivel** section specify **NS95**

BRAKE OPTIONS

To order, add brake code below to end of model. Example: 95PY10709SBBLP

Poly Cam specify **P**



Face Contact specify **F**



Welded Swivel Lock specify **L**



BEARING OPTIONS

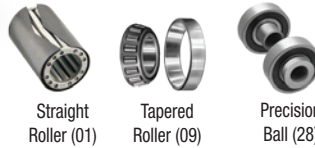

Hand operated field installable **Swivel Lock** order **SL954600** separately (Yokes must be notched)

+ For Rigid models change "SBBL" to "RBBL" to end of base caster number.

Wheel Diameter (Inches)	Tread Width (Inches)	Capacity (Lbs) (Rate for manual operation)	Overall Height (Inches)	Swivel Lead (Inches)	Approx. Wt. (Lbs)	Caster Number+
-------------------------	----------------------	--	-------------------------	----------------------	-------------------	----------------

Thick Tread Polyurethane (09 Tapered Roller Bearing)*

PX	Wheel Diameter	Tread Width	Capacity	Overall Height	Swivel Lead	Approx. Wt.	Caster Number
	8	4	3850	11	2 1/4	63	95PX08709SBBL
	10	4	4620	13	2 1/2	71	95PX10709SBBL
	12	4	5280	15 1/2	2 1/2	76 1/4	95PX12709SBBL
	12	5	6600	15 1/2	2 1/2	90	95PX12809SBBL
	16	4	6570	19	3	111 1/2	95PX16709SBBL
	16	5	8470	19	3	126 1/4	95PX16809SBBL

*Roller Bearings (01) available. To order change bearing code. Example 95PX08701SBBL.

Phenolic (09 Tapered Roller Bearing)

TM	Wheel Diameter	Tread Width	Capacity	Overall Height	Swivel Lead	Approx. Wt.	Caster Number
	8	6*	5000	11	2 1/2	54 1/2	95TM08909SBBL
	10	3	2900	13	2 1/2	27	95TM10509SBBL
	10	6*	5800	13	2 1/2	54	95TM10909SBBL
	12	4	8000	15 1/2	2 1/2	67 1/2	95TM12709SBBL

*2 wheels bolted together.

Laminated Phenolic (01 Roller Bearing/09 Tapered Roller Bearing)*

TL	Wheel Diameter	Tread Width	Capacity	Overall Height	Swivel Lead	Approx. Wt.	Caster Number
	6	5	8000	9	2 1/4	46	95TL06809SBBL
	8	6**	5000	11	2 1/2	54	95TL08909SBBL
	10	6**	5800	13	2 1/2	61 1/4	95TL10909SBBL
	12	3 1/2	4000	15 1/2	2 1/2	58 3/4	95TL12601SBBL
	16	4	8000	19	3	79 3/4	95TL16701SBBL

*Tapered Roller Bearings (09) available. To order change bearing code. Example 95TL08709SBBL. **2 wheels bolted together.

Drop Forged Steel (01 Roller or 09 Tapered Roller Bearing)

FS	Wheel Diameter	Tread Width	Capacity	Overall Height	Swivel Lead	Approx. Wt.	Caster Number
	6	3	6000	9	2 1/4	60 1/4	95FS06501SBBL
	6	3	8000	9	2 1/4	59 1/2	95FS06509SBBL
	8	4	8000	11	2 1/4	61 1/2	95FS08701SBBL
	8	4	8000	11	2 1/4	72 1/2	95FS08709SBBL
	10	3	5000	13	2 1/2	78 1/2	95FS10501SBBL
	10	4	8000	13	2 1/2	86 1/4	95FS10701SBBL
	10	4	8000	13	2 1/2	86 1/2	95FS10709SBBL

Ductile Iron (09 Tapered Roller Bearing)*

FM	Wheel Diameter	Tread Width	Capacity	Overall Height	Swivel Lead	Approx. Wt.	Caster Number
	12	3 1/2	6000	15 1/2	2 1/2	83 1/2	95FM12609SBBL

*Roller Bearings (01) available. To order change "09" to other bearing code. Example: 95FM12601SBBL.

95

95 TRL Super Duty Casters (Tapered Thrust Swivel Section)

CAPACITY TO 17000



This popular caster series has a precision roller bearing load and thrust swivel section (thrust swivel section = "TRL"). Rigs are precision machined to provide long life with greater capacity for that very rugged application. Made from AISI 1045 drop forged steel.

TYPICAL APPLICATIONS

- Die carts
- Towed trailers
- Automotive plants

SWIVEL CROSS SECTION

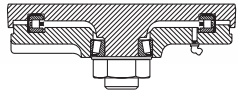

MOUNTING OPTIONS

Standard Plate

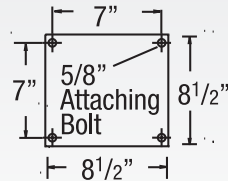

Special Order Plate

Optional T Plate

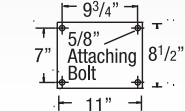

+ For Rigid models change "STRL" to "RTRL" to end of base caster number.

Moldon Rubber on Cast Iron (01 Roller)

MR	Wheel Diameter (inches)	Tread Width (inches)	Capacity (Lbs) (Rated for manual operation)	Overall Height (inches)	Swivel Lead (inches)	Approx. Wt. (Lbs)	Caster Number+
	10	4	1400	13	2 1/2	64 3/4	95MR10701STRL
	12	4	1600	15 1/2	2 1/2	55 3/4	95MR12701STRL
	16	5	2570	19	3	105 1/4	95MR16801STRL

Polyurethane on Cast Iron (09 Tapered Roller Bearing)*

PY	Wheel Diameter (inches)	Tread Width (inches)	Capacity (Lbs) (Rated for manual operation)	Overall Height (inches)	Swivel Lead (inches)	Approx. Wt. (Lbs)	Caster Number+
	8	4	3800	11	2 1/4	63	95PY08709STRL
	10	4	4200	13	2 1/2	71	95PY10709STRL
	10	5	5000	13	2 1/2	82	95PY10809STRL
	12	3 1/2	4110	15 1/2	2 1/2	73 1/2	95PY12609STRL
	12	4	4800	15 1/2	2 1/2	76 1/4	95PY12709STRL
	12	5	6000	15 1/2	2 1/2	90	95PY12809STRL
	16	4	5970	19	3	111 1/2	95PY16709STRL
	16	5	7700	19	3	126 1/4	95PY16809STRL

*Roller (01) bearings available. To order change "09" to other bearing code. Example: 95PY08701STRL.



Premium Quality



Towing^



Environmentally Friendly

FEATURES

- **Top Plate and Yoke Base:** 5/8" thick AISI 1045 drop-forged steel precision machined for bearings
- **Swivel Load Bearings:** 7" diameter machined raceway with a precision tapered roller bearing which is protected by a forged labyrinth skirt
- **Component Thrust Bearing:** 1-1/4" tapered roller bearing
- **Legs:** 1/2" steel plate formed for greater strength and welded to yoke base both inside and outside
- **King Bolt:** 1-1/4" integrally forged with top plate machined and threaded
- **Axle:** 1-1/4" solid axle and lock nut
- Alternate or custom caster configurations available

RIG OPTIONS

- **Sealed swivel** section specify **NS95**

BRAKE OPTIONS

To order, add brake code below to end of model. Example: 95PY08709STRLP

Poly Cam specify **P**



Face Contact specify **F**

Welded Swivel Lock specify **L**



BEARING OPTIONS

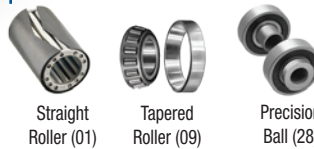

Straight Roller (01)

Tapered Roller (09)

Precision Ball (28)



Hand operated field installable **Swivel Lock** order **SL954600** separately (Yokes must be notched)

+ For Rigid models change "STRL" to "RTRL" to end of base caster number.

Wheel Diameter (inches)	Tread Width (inches)	Capacity (Lbs) (Rated for manual operation)	Overall Height (inches)	Swivel Lead (inches)	Approx. Wt. (Lbs)	Caster Number+
-------------------------	----------------------	---	-------------------------	----------------------	-------------------	----------------

Thick Tread Polyurethane (09 Tapered Roller Bearing)*

PX	Wheel Diameter (inches)	Tread Width (inches)	Capacity (Lbs) (Rated for manual operation)	Overall Height (inches)	Swivel Lead (inches)	Approx. Wt. (Lbs)	Caster Number+
	8	4	3850	11	2 1/4	63	95PX08709STRL
	10	4	4620	13	2 1/2	71	95PX10709STRL
	12	4	5280	15 1/2	2 1/2	76 1/4	95PX12709STRL
	12	5	6600	15 1/2	2 1/2	90	95PX12809STRL
	16	4	6570	19	3	111 1/2	95PX16709STRL
	16	5	8470	19	3	126 1/4	95PX16809STRL

*Roller (01) bearings available. To order change "09" to other bearing code. Example: 95PX08701STRL.

Continue on next page >>

+ For Rigid models change "STRL" to "RTRL" to end of base caster number.

	Wheel Diameter (Inches)		Tread Width (Inches)		Capacity (Lbs) (Based on manual operation)		Overall Height (Inches)		Swivel Lead (Inches)		Approx. Wt. (Lbs)		Caster Number +
--	-----------------------------------	--	--------------------------------	--	--	--	-----------------------------------	--	--------------------------------	--	-----------------------------	--	------------------------

Phenolic (09 Tapered Roller Bearing)

TM 	8	6*	5000	11	2 1/2	54 1/2	95TM08909STRL
	10	6*	5800	13	2 1/2	54	95TM10909STRL
	12	4	8000	15 1/2	2 1/2	67 1/2	95TM12709STRL

*2 wheels bolted together.

Laminated Phenolic (01 Roller Bearing/09 Tapered Roller Bearing)**

TL 	6	5	8000	9	2 1/4	46	95TL06809STRL
	8	6*	5000	11	2 1/2	54	95TL08909STRL
	10	6*	5800	13	2 1/2	61 1/4	95TL10909STRL
	12	3 1/2	4000	15 1/2	2 1/2	58 3/4	95TL12601STRL
	16	4	8000	19	3	79 3/4	95TL16701STRL

*2 wheels bolted together.

**Tapered Roller Bearings (09) available.

To order change "01" to other bearing code.

Example: 95TL06801STRL.

Drop Forged Steel (01 Roller or 09 Tapered Roller Bearing)

FS 	6	3	6000	9	2 1/4	60 1/4	95FS06501STRL
	6	3	10000	9	2 1/4	59 1/2	95FS06509STRL
	8	4	8000	11	2 1/4	61 1/2	95FS08701STRL
	8	4	10000	11	2 1/4	72 1/2	95FS08709STRL
	10	3	6500	13	2 1/2	78 1/2	95FS10509STRL
	10	4	8350	13	2 1/2	86 1/4	95FS10701STRL
10	4	10000	13	2 1/2	86 1/2	95FS10709STRL	

+ For Rigid models change "STRL" to "RTRL" to end of base caster number.

	Wheel Diameter (Inches)		Tread Width (Inches)		Capacity (Lbs) (Based on manual operation)		Overall Height (Inches)		Swivel Lead (Inches)		Approx. Wt. (Lbs)		Caster Number +
--	-----------------------------------	--	--------------------------------	--	--	--	-----------------------------------	--	--------------------------------	--	-----------------------------	--	------------------------

Large Bore Drop Forged Steel (09 Tapered Roller Bearing)

FH 	6	3	17000	9	2 1/4	59 1/2	95FH06509STRL
	8	4	17000	11	2 1/4	72 1/2	95FH08709STRL
	10	3	6000	13	2 1/2	78 1/2	95FH10509STRL
	10	4	17000	13	2 1/2	86 1/2	95FH10709STRL

V-Groove Drop Forged Steel (01 Roller Bearing/09 Tapered Roller Bearing)

VF 	6	3	6000	9	2 1/4	59 1/2	95VF06501STRL
	6	3	6500	9	2 1/4	45	95VF06509STRL
	8	4	8350	11	2 1/4	61 1/2	95VF08701STRL
	10	3	6000	13	2 1/2	67 3/4	95VF10501STRL
	10	3	6000	13	2 1/2	67 3/4	95VF10509STRL
	10	4	8350	13	2 1/2	89 1/2	95VF10701STRL

Large Bore V-Groove Drop Forged Steel (09 Tapered Roller Bearing)

VH 	6	3	10000	9	2 1/4	45	95VH06509STRL
	8	4	15000	11	2 1/4	61 1/2	95VH08709STRL
	10	4	15000	13	2 1/2	86 1/4	95VH10709STRL

Ductile Iron (01 Roller Bearing)

FM 	12	3 1/2	6000	15 1/2	2 1/2	83 1/2	95FM12601STRL
---------------	----	-------	------	--------	-------	--------	---------------

Sometimes Even HEAVY DUTY CASTERS Need Protection from the Elements.

- Prevent corrosion and increase your caster life
- Maintain clean and safe operations
- Keep rolling in the toughest environments



05 SERIES

Pages 78 – 79



330 KINGPINLESS

Page 84



E5 ECONOMY SERIES

Pages 85 – 86



04 SERIES

Page 77



120 KINGPINLESS

Pages 80 – 81

ALBION
the caster experts

STAINLESS STEEL CASTERS

CAPACITY RANGE 200-3000 LBS



330 Series

Kingpinless Polished Stainless Steel Casters

120 Series



Stainless Steel

Common Applications:

- Food Processing/ Manufacturing
- Food Service
- Pharmaceuticals
- Laboratory
- Clean Room
- Hospital
- Bakery Dough Troughs
- Marine

Stainless Steel Kingpin Casters



04 Series Light Duty

Capacity to 350 77



05 Series Medium Heavy Duty

Capacity to 1200 78-79

Stainless Steel Kingpinless Casters



120 Series Kingpinless

Capacity to 1200 80-81



330 Kingpinless

Capacity to 3000 84

Economy Stainless Steel Kingpin Casters



E5 Economy Series

Capacity to 900 85-86

- Why Prevenz™ Wheels?
See pages 82-83

Albion offers the leading lineup of Stainless Kingpinless casters... handling even your toughest jobs.



KINGPINLESS STAINLESS STEEL CASTERS

- Premium 304 type stainless steel plates and legs
- Premium 316 type stainless swivel section/yoke base for even greater strength and corrosion protection
- Kingpinless design is a proven workhorse for the most abusive applications
- See pages 80-84

Sometimes Even **HEAVY DUTY CASTERS** Need Protection from the Elements.

- Prevent corrosion and increase your caster life
- Maintain clean and safe operations
- Keep rolling in the toughest environments



04 SERIES
Page 77



E5 ECONOMY SERIES
Pages 85 – 86



05 SERIES
Pages 78 – 79



120 KINGPINLESS
Pages 80 – 81



330 KINGPINLESS
Page 84



NW Wheel
Economical, Strong, Clean.



PREVENZ™
The antimicrobial compound used in Prevenz™ wheels is designed to suppress the growth of a variety of destructive and odor causing microbes.

See pages 82 – 83 for more details.

Just look for this
Stainless Steel badge!



**Stainless
Steel**

ALBION®
the caster experts

04

Light Duty Stainless Steel Casters

CAPACITY TO 350



These polished stainless steel casters are designed for light-duty applications where frequent washdowns are necessary. Ideally suited for applications exposed to cleaning agents, steam, caustic solutions, or other corrosive agents which could cause rust or corrosion.

TYPICAL APPLICATIONS

- Food Service
- Pharmaceuticals
- Laboratories
- Hospitals

SWIVEL CROSS SECTION

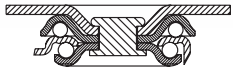

MOUNTING OPTION

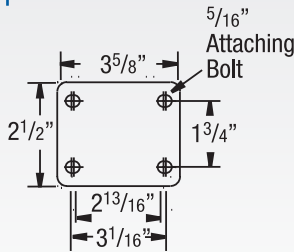

FEATURES

- **Top Plate & Yoke:** Heavily embossed, Type 304 formed stainless steel to extend caster life under rugged conditions
- **Swivel Section:** Double stainless steel ball bearing raceways to resist wear and improve maneuverability
- **Finish:** "Polished" stainless steel finish maintains appearance in severe conditions
- **Kingpin:** 1/2" hydraulically formed stainless steel rivet
- **Axle:** 3/8" diameter Type 304 stainless steel solid axle with lock nut
- **Component Parts:** Bushing, axle and nut are all stainless steel
- **NSF:** Listed for food service industry
- Alternate or custom caster configurations available

RIG OPTIONS

- Sealed swivel specify **SS01**

BRAKE OPTIONS

To order, add brake code below to end of model. Example: 04XS05051SGL

Grip Lock specify **GL**



Face Contact specify **F**

BEARING OPTIONS

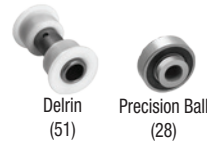

+ For swivel models add "S", for rigid model add "R" to end of base caster number.

Wheel Diameter (Inches)	Tread Width (Inches)	Capacity (Lbs) (Rating for normal operation)	Overall Height (Inches)	Swivel Lead (Inches)	Approx. Wt. (Lbs)	Base Caster Number+
-------------------------	----------------------	--	-------------------------	----------------------	-------------------	---------------------

Polypropylene (51 Delrin Bearing)

PB	3	1 1/4	250	4 1/4	1 5/16	1.50	04PB03051
	4	1 1/4	350	5 1/8	1 1/4	2.13	04PB04051
	5	1 1/4	350	6 3/16	1 1/2	2.63	04PB05051

Polyurethane on Polypropylene (51 Delrin Bearing)

XA	3	1 1/4	300	4 1/4	1 5/16	1.50	04XA03051
	3 1/2	1 1/4	350	4 11/16	1 1/4	1.75	04XA03X51
	4	1 1/4	350	5 1/8	1 1/4	2.50	04XA04051
	5	1 1/4	350	6 3/16	1 1/2	2.75	04XA05051

Prevenz™ antimicrobial models available. Add PREV to end of caster number.

Hi-Temp Phenolic (41 Plain Bore)

TR	4	1 1/4	300	5 1/8	1 1/4	2.50	04TR04041
	5	1 1/4	325	6 3/16	1 1/2	2.75	04TR05041

Phenolic (41 Plain Bore)

TM	3	1 1/4	350	4 1/4	1 5/16	1.50	04TM03041
	3 1/2	1 1/4	350	4 11/16	1 1/4	2.00	04TM03X41
	4	1 1/4	350	5 1/8	1 1/4	2.50	04TM04041
	5	1 1/4	350	6 3/16	1 1/2	2.75	04TM05041

	Wheel Diameter (Inches)	Tread Width (Inches)	Capacity (Lbs) (Rating for normal operation)	Overall Height (Inches)	Swivel Lead (Inches)	Approx. Wt. (Lbs)	Base Caster Number+
--	-------------------------	----------------------	--	-------------------------	----------------------	-------------------	---------------------

X-tra Soft Rubber Flat Tread (51 Delrin Bearing)*

XS	3	1 1/4	200	4 1/4	1 5/16	1.50	04XS03051
	3 1/2	1 1/4	250	4 11/16	1 1/4	1.75	04XS03X51
	4	1 1/4	300	5 1/8	1 1/4	2.50	04XS04051
	5	1 1/4	325	6 3/16	1 1/2	2.63	04XS05051

*Plain bore (41) bearing available. To order change "51" to other bearing code. Example: 04XS03041.

Prevenz™ antimicrobial models available. Add PREV to end of caster number.

Precision X-tra Soft Round Tread (28 Precision Ball Bearing)

XR	3	1 1/4	200	4 1/4	1 5/16	1.50	04XR03028
	3 1/2	1 1/4	250	4 11/16	1 1/4	1.75	04XR03X28
	4	1 1/4	300	5 1/8	1 1/4	2.25	04XR04028
	5	1 1/4	325	6 3/16	1 1/2	2.63	04XR05028

05

Medium Heavy Duty Stainless Steel Casters

CAPACITY TO 1200



This caster is the ideal solution for applications where frequent washdowns are necessary. The stainless steel caster is also well suited for applications exposed to cleaning agents, steam, caustic solutions, or other corrosive agents which could cause rust.

MOUNTING OPTION

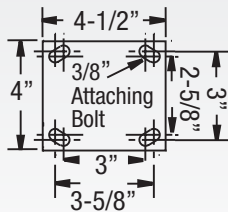

SWIVEL CROSS SECTION

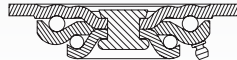

TYPICAL APPLICATIONS

- Food Processing/Service
- Bakery Dough Troughs
- Stainless Carts
- Pharmaceuticals
- Laboratory
- Clean Room
- Hospital Waste Management
- Marine
- Dollies



Stainless Steel



Premium Quality



Environmentally Friendly

FEATURES

- **Top Plate & Yoke:** Formed from superior 1/4" Type 304 stainless steel plate
- **Finish:** Highly polished stainless steel
- **Swivel Section:** Double stainless steel ball bearing raceways formed smooth for ease of swiveling
- **King Pin:** Stainless steel rivet
- **Axle:** 1/2" diameter, stainless steel hollow with roller bearing. Solid axle with Delrin and precision ball bearings
- **Legs:** 1/4" stainless steel formed for added strength welded to the yoke base
- **Spanner Bushing:** Type 304 Stainless Steel
- **Zerk Fitting:** Type 304 Stainless Steel
- **NSF** Consult factory
- Alternate or custom caster configurations available

RIG OPTIONS

- **Neoprene sealed swivel** section specify **NS05**
- **Notched seal kit** specify **SD016001**

BRAKE OPTIONS

To order, add brake code below to end of model. Example: 05XS06201SCB

Stainless Steel Cam specify **CB**. Specify 1 Piece Delrin Bearing (52)



Face
Specify **FBD**

Face
Specify **FBG**



Swivel Lock
(welded)
specify **L**

BEARING OPTIONS



Note: Wheel capacities can change with each bearing type. Consult factory.

+ For swivel models add "S", for rigid model add "R" to end of base caster number.

X-tra Soft (Flat Tread) (01 Stainless Steel Roller Bearing)*

Model	Wheel Diameter (inches)	Tread Width (inches)	Capacity (lbs)	Overall Height (inches)	Swivel Lead (inches)	Approx. Wk. (lbs)	Base Caster Number+
XS	4	2	400	5 ⁵ / ₈	17/16	5 ¹ / ₄	05XS04201
	5	2	500	6 ¹ / ₂	1 ⁵ / ₈	5 ¹ / ₄	05XS05201
	6	2	600	7 ¹ / ₂	17/8	5 ³ / ₄	05XS06201
	8	2	675	9 ¹ / ₂	2 ³ / ₈	6	05XS08201

Prevenz™ antimicrobial models available. Add PREV to end of caster number. *Delrin (51) Bearings available. To order change "01" to other bearing code. Delrin example: 05XS04251.

X-tra Soft Round Tread (01 Stainless Steel Roller Bearing)*

Model	Wheel Diameter (inches)	Tread Width (inches)	Capacity (lbs)	Overall Height (inches)	Swivel Lead (inches)	Approx. Wk. (lbs)	Base Caster Number+
XR	6	2	450	7 ¹ / ₂	17/8	5 ³ / ₄	05XR06201
	8	2	600	9 ¹ / ₂	2 ³ / ₈	6	05XR08201

Prevenz™ antimicrobial models available. Add PREV to end of caster number. *Delrin (51) Bearings available. To order change "01" to other bearing code. Delrin example: 05XR06251.

Moldon on Rubber on Aluminum (01 Stainless Steel Roller Bearing)

Model	Wheel Diameter (inches)	Tread Width (inches)	Capacity (lbs)	Overall Height (inches)	Swivel Lead (inches)	Approx. Wk. (lbs)	Base Caster Number+
MD	4	1 ¹ / ₂	250	5 ⁵ / ₈	17/16	4 ³ / ₄	05MD04101
	5	1 ¹ / ₂	300	6 ¹ / ₂	1 ⁵ / ₈	5	05MD05101
	6	2	550	7 ¹ / ₂	17/8	6	05MD06201
	8	2	600	9 ¹ / ₂	2 ³ / ₈	6 ¹ / ₂	05MD08201

+ For swivel models add "S", for rigid model add "R" to end of base caster number.

Polypropylene (01 Stainless Steel Roller Bearing)*

Model	Wheel Diameter (inches)	Tread Width (inches)	Capacity (lbs)	Overall Height (inches)	Swivel Lead (inches)	Approx. Wk. (lbs)	Base Caster Number+
PB	4	2	450	5 ⁵ / ₈	17/16	3 ³ / ₄	05PB04201
	5	2	550	6 ¹ / ₂	1 ⁵ / ₈	4 ¹ / ₂	05PB05201
	6	2	650	7 ¹ / ₂	17/8	4 ³ / ₄	05PB06201
	8	2	850	9 ¹ / ₂	2 ³ / ₈	6 ¹ / ₄	05PB08201

*Delrin (51) Bearings available. To order change "01" to other bearing code. Delrin example: 05PB06251.

RETORT High Temp Polypropylene (41 Plain Bore)

Model	Wheel Diameter (inches)	Tread Width (inches)	Capacity (lbs)	Overall Height (inches)	Swivel Lead (inches)	Approx. Wk. (lbs)	Base Caster Number+
RW	4	2	500	5 ⁵ / ₈	17/16	3 ³ / ₄	05RW04241
	5	2	650	6 ¹ / ₂	1 ⁵ / ₈	5 ¹ / ₄	05RW05241
	6	2	700	7 ¹ / ₂	17/8	5 ¹ / ₂	05RW06241
	8	2	900	9 ¹ / ₂	2 ³ / ₈	6 ¹ / ₄	05RW08241

Polyurethane on Alum. Round Tread (28 Stainless Precision Ball Bearing)

Model	Wheel Diameter (inches)	Tread Width (inches)	Capacity (lbs)	Overall Height (inches)	Swivel Lead (inches)	Approx. Wk. (lbs)	Base Caster Number+
PM	5	2	1000	6 ¹ / ₂	1 ⁵ / ₈	6	05PM05228
	6	2	1200	7 ¹ / ₂	17/8	7	05PM06228
	8	2	1200	9 ¹ / ₂	2 ³ / ₈	9	05PM08228

Continue on next page >>

+ For swivel models add "S", for rigid model add "R" to end of base caster number.

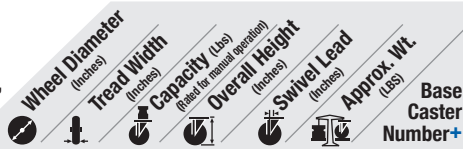

Eagle Polyurethane on Polypropylene (01 Stainless Roller Bearing)*							
EG 	4	2	600	5 ⁵ / ₈	1 ⁷ / ₁₆	5	05EG04201
	5	2	900	6 ¹ / ₂	1 ⁵ / ₈	5 ¹ / ₄	05EG05201
	6	2	1100	7 ¹ / ₂	1 ⁷ / ₈	5 ³ / ₄	05EG06201
	8	2	1200	9 ¹ / ₂	2 ³ / ₈	7	05EG08201

*Delrin (51) Bearings available. To order change "01" to other bearing code. Delrin Example: 05EG04251.

Polyurethane on Polypropylene (01 Stainless Steel Roller Bearing)*							
XA 	4	2	600	5 ⁵ / ₈	1 ⁷ / ₁₆	5	05XA04201
	5	2	750	6 ¹ / ₂	1 ⁵ / ₈	5 ¹ / ₄	05XA05201
	6	2	900	7 ¹ / ₂	1 ⁷ / ₈	5 ³ / ₄	05XA06201
	8	2	1000	9 ¹ / ₂	2 ³ / ₈	7	05XA08201

Prevenz™ antimicrobial models available. Add PREV to end of caster number.
*Delrin (51) Bearings available. Change "01" to other bearing code. Delrin Example: 05XA04251.

X-Treme™ Plus Solid Polyurethane (01 Stainless Steel Roller Bearing)							
XP 	4	2	1200	5 ⁵ / ₈	1 ⁷ / ₁₆	4 ¹ / ₄	05XP04201
	5	2	1200	6 ¹ / ₂	1 ⁵ / ₈	5	05XP05201
	6	2	1200	7 ¹ / ₂	1 ⁷ / ₈	5 ¹ / ₂	05XP06201
	8	2	1200	9 ¹ / ₂	2 ³ / ₈	6 ¹ / ₂	05XP08201

*Bronze (22), Stainless Pedestal Precision (29), Annular Ball (31) and Delrin (51) bearings available. To order change "01" to other bearing code. Stainless Pedestal Precision example: 05XP04229.

X-Treme™ Solid Polyurethane (01 Stainless Steel Roller Bearing)*							
XI 	4	2	1000	5 ⁵ / ₈	1 ⁷ / ₁₆	4 ¹ / ₄	05XI04201
	5	2	1000	6 ¹ / ₂	1 ⁵ / ₈	5	05XI05201
	6	2	1000	7 ¹ / ₂	1 ⁷ / ₈	5 ¹ / ₂	05XI06201
	8	2	1000	9 ¹ / ₂	2 ³ / ₈	6 ¹ / ₂	05XI08201

*Bronze (22), Stainless Pedestal Precision (29), Annular Ball (31) and Delrin (51) bearings available. To order change "01" to other bearing code. Stainless Pedestal Precision example: 05XI04229.

Solid Elastomer (01 Stainless Steel Roller Bearing)*							
SE 	4	2	1000	5 ⁵ / ₈	1 ⁷ / ₁₆	4 ¹ / ₄	05SE04201
	5	2	1000	6 ¹ / ₂	1 ⁵ / ₈	5	05SE05201
	6	2	1100	7 ¹ / ₂	1 ⁷ / ₈	5 ¹ / ₂	05SE06201
	8	2	1200	9 ¹ / ₂	2 ³ / ₈	6 ¹ / ₂	05SE08201

*Bronze (22) and Stainless Pedestal Precision (29) bearings available. To order change "01" to other bearing code. Pedestal Precision example: 05SE04229.

Phenolic (01 Stainless Steel Roller Bearing)*							
TM 	4	2	800	5 ⁵ / ₈	1 ⁷ / ₁₆	5	05TM04201
	5	2	1000	6 ¹ / ₂	1 ⁵ / ₈	5 ¹ / ₄	05TM05201
	6	2	1200	7 ¹ / ₂	1 ⁷ / ₈	6 ¹ / ₄	05TM06201
	8	2	1200	9 ¹ / ₂	2 ³ / ₈	8	05TM08201

*Delrin (51) Bearings available. To order change "01" to other bearing code. Delrin example: 05TM06251.

Straight Sided Phenolic (01 Stainless Steel Roller Bearing)*							
TH 	4	2	800	5 ⁵ / ₈	1 ⁷ / ₁₆	5	05TH04201
	5	2	1000	6 ¹ / ₂	1 ⁵ / ₈	5 ¹ / ₂	05TH05201
	6	2	1200	7 ¹ / ₂	1 ⁷ / ₈	6 ¹ / ₄	05TH06201

*Delrin (51) Bearings available. To order change "01" to other bearing code. Delrin example: 05TH06251.

+ For swivel models add "S", for rigid model add "R" to end of base caster number.

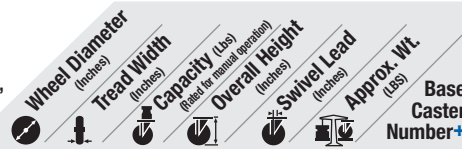



Maxim® (01 Stainless Steel Roller Bearing)*							
NG 	4	2	800	5 ⁵ / ₈	1 ⁷ / ₁₆	5	05NG04201
	5	2	1000	6 ¹ / ₂	1 ⁵ / ₈	5 ¹ / ₄	05NG05201
	6	2	1200	7 ¹ / ₂	1 ⁷ / ₈	5 ³ / ₄	05NG06201
	8	2	1200	9 ¹ / ₂	2 ³ / ₈	7	05NG08201

Prevenz™ antimicrobial models available. Add PREV to end of caster number.
*Bronze (22), Stainless Pedestal Precision (29), Annular Ball (31) and Delrin (51) bearings available. To order change "01" to other bearing code. Stainless Pedestal Precision example: 05NG04229.

White Nylon (01 Stainless Steel Roller Bearing)*							
NW 	5	2	600	6 ¹ / ₂	1 ⁵ / ₈	5 ¹ / ₄	05NW05201
	6	2	900	7 ¹ / ₂	1 ⁷ / ₈	5 ³ / ₄	05NW06201
	8	2	1100	9 ¹ / ₂	2 ³ / ₈	6 ¹ / ₂	05NW08201

*Delrin (51) Bearings available. To order change "01" to other bearing code. Delrin example: 05NW06251.

Glass Filled Polypropylene (01 Stainless Steel Roller Bearing)							
RT 	4	2	800	5 ⁵ / ₈	1 ⁷ / ₁₆		05RT04201
	5	2	1000	6 ¹ / ₂	1 ⁵ / ₈		05RT05201
	6	2	1200	7 ¹ / ₂	1 ⁷ / ₈		05RT06201
	8	2	1200	9 ¹ / ₂	2 ³ / ₈		05RT08201

High Temp Glass Filled Nylon (01 Stainless Steel Roller Bearing)							
HT 	4	2	800	5 ⁵ / ₈	1 ⁷ / ₁₆		05HT04201
	5	2	1000	6 ¹ / ₂	1 ⁵ / ₈		05HT05201
	6	2	1200	7 ¹ / ₂	1 ⁷ / ₈		05HT06201
	8	2	1200	9 ¹ / ₂	2 ³ / ₈		05HT08201

Prevenz™ Antimicrobial Wheels
The EPA registered and FDA compliant antimicrobial additive used in Prevenz™ wheels is designed to suppress the growth of a variety of destructive and odor causing microbes including bacteria, molds, mildew and fungi. To order add "PREV" to end of caster number.



XS Prevenz™ XR Prevenz™ XA Prevenz™ NG Prevenz™

05 SERIES • CAPACITY TO 1200

STAINLESS STEEL

120

Contender™ Kingpinless Stainless Steel CAPACITY TO 1200



The 120 Series is constructed from 304 stainless steel and features a precision machined swivel section that is welded inside and outside to legs for maximum durability. The stainless construction is highly polished and ideal for applications exposed to cleaning agents, washdowns, caustic solutions, steam, marine environments or any other corrosive agents that could cause rust.

TYPICAL APPLICATIONS

- Food Processing
- Bakery Dough Troughs
- Stainless Carts
- Pharmaceuticals
- Laboratory
- Hospital Waste Management
- Marine
- Dollies

SWIVEL CROSS SECTION



MOUNTING OPTIONS

Standard Plate

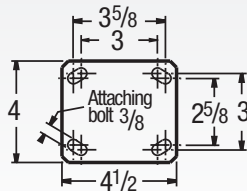

Special Order Plate*

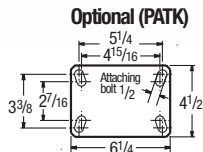

* Available on 6" and 8" wheel diameter models; consult factory



Stainless Steel



Premium Quality



Ergonomic



Environmentally Friendly



Towing^

FEATURES

- **Top Plate:** 5/16" 304 stainless steel and welded construction for longer life
- **Yoke Base:** Notched 304 stainless steel welded inside and out
- **Legs:** 304 stainless welded inside and out
- **Swivel Section:** One row of 3/8" ball bearings mounted in a precision machined raceway. Zerk in swivel section
- **Axle:** 1/2" diameter hollow axle with zerk fitting on roller and tapered bearing models (Solid axle on Delrin, and precision ball models)
- **NSF:** Consult Factory
- Alternate or custom caster configurations available

RIG OPTIONS

- **Optional Overall height** of 10-1/8" available for 8" wheel diameter models; to specify, remove "-01" from end of caster number

BRAKE OPTIONS

To order, add brake code below to end of model. Example: 120XS06201S**FBD**

Single Side specify **SSB120**. **Double Sided** specify **DSB120**



Face specify **FBD**

Face specify **FBG**



Hand operated field installable swivel lock order **L**

BEARING OPTIONS



+ For swivel models add "S", for rigid model add "R" to end of base caster number.



X-tra Soft (Round Tread) (01 Stainless Steel Roller Bearing)*

XR	Wheel Diameter (Inches)	Tread Width (Inches)	Capacity (Lbs) (Based on normal operation)	Overall Height (Inches)	Swivel Lead (Inches)	Base Caster Number+
	6	2	450	7 1/2	19/16	120XR06201
	8	2	600	9 1/2	2 1/4	120XR08201S-01

Prevenz™ antimicrobial models available. Add PREV to end of model.
*Delrin (51) Bearings available.
To order change "01" to other bearing code.
Delrin example: 120XR06251.

Polypropylene (01 Stainless Steel Roller Bearing)*

PB	Wheel Diameter (Inches)	Tread Width (Inches)	Capacity (Lbs) (Based on normal operation)	Overall Height (Inches)	Swivel Lead (Inches)	Base Caster Number+
	4	2	450	5 5/8	13/16	120PB04201
	5	2	650	6 1/2	1 3/8	120PB05201
	6	2	750	7 1/2	19/16	120PB06201
	8	2	1000	9 1/2	2 1/4	120PB08201S-01

*Delrin (51) Bearings available.
To order change "01" to other bearing code.
Delrin example: 120PB06251.

RETORT High Temp Polypropylene (41 Plain Bore)

RW	Wheel Diameter (Inches)	Tread Width (Inches)	Capacity (Lbs) (Based on normal operation)	Overall Height (Inches)	Swivel Lead (Inches)	Base Caster Number+
	4	2	500	5 5/8	13/16	120RW04241
	5	2	650	6 1/2	1 3/8	120RW05241
	6	2	700	7 1/2	19/16	120RW06241
	8	2	900	9 1/2	2 1/4	120RW08241S-01



X-tra Soft (Flat Tread) (01 Stainless Steel Roller Bearing)*

XS	Wheel Diameter (Inches)	Tread Width (Inches)	Capacity (Lbs) (Based on normal operation)	Overall Height (Inches)	Swivel Lead (Inches)	Base Caster Number+
	4	2	400	5 5/8	13/16	120XS04201
	5	2	500	6 1/2	1 3/8	120XS05201
	6	2	600	7 1/2	19/16	120XS06201
	8	2	675	9 1/2	2 1/4	120XS08201S-01

Prevenz™ antimicrobial models available. Add PREV to end of model.
*Delrin (51) Bearings available.
To order change "01" to other bearing code.
Delrin example: 120XS04251.

+ For swivel models add "S", for rigid model add "R" to end of base caster number.

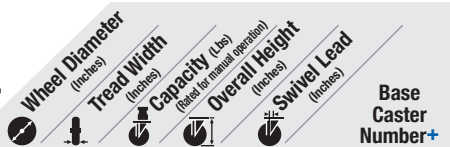

Polyurethane on Aluminum Round Tread (28 Stainless Precision Ball Bearings)

Model	Wheel Diameter (inches)	Tread Width (inches)	Capacity (lbs) (Rated for manual operation)	Overall Height (inches)	Swivel Lead (inches)	Base Caster Number+
PM	5	2	1000	6 1/2	1 3/8	120PM05228
	6	2	1200	7 1/2	1 9/16	120PM06228
	8	2	1200	9 1/2	2 1/4	120PM08228S-01

Eagle Polyurethane on Polypropylene (28 Stainless Precision Ball Bearing)*

Model	Wheel Diameter (inches)	Tread Width (inches)	Capacity (lbs) (Rated for manual operation)	Overall Height (inches)	Swivel Lead (inches)	Base Caster Number+
EG	4	2	600	5 5/8	1 3/16	120EG04228
	5	2	900	6 1/2	1 3/8	120EG05228
	6	2	1100	7 1/2	1 9/16	120EG06228
	8	2	1200	9 1/2	2 1/4	120EG08228S-01

*Delrin (51) Bearings available. To order change "28" to other bearing code. Delrin example: 120EG04251.

Polyurethane on Polypropylene (01 Stainless Steel Roller Bearing)*

Model	Wheel Diameter (inches)	Tread Width (inches)	Capacity (lbs) (Rated for manual operation)	Overall Height (inches)	Swivel Lead (inches)	Base Caster Number+
XA	4	2	600	5 5/8	1 3/16	120XA04201
	5	2	750	6 1/2	1 3/8	120XA05201
	6	2	900	7 1/2	1 9/16	120XA06201
	8	2	1000	9 1/2	2 1/4	120XA08201S-01

Prevenz™ antimicrobial models available. Add PREV to end of model. *Delrin (51) Bearings available. To order change "01" to other bearing code. Delrin example: 120XA04251.

X-Treme™ Plus Solid Polyurethane (01 Stainless Steel Roller Bearing)

Model	Wheel Diameter (inches)	Tread Width (inches)	Capacity (lbs) (Rated for manual operation)	Overall Height (inches)	Swivel Lead (inches)	Base Caster Number+
XP	4	2	1200	5 5/8	1 3/16	120XP04201
	5	2	1200	6 1/2	1 3/8	120XP05201
	6	2	1200	7 1/2	1 9/16	120XP06201
	8	2	1200	9 1/2	2 1/4	120XP08201S-01

X-Treme™ Solid Polyurethane (01 Stainless Steel Roller Bearing)

Model	Wheel Diameter (inches)	Tread Width (inches)	Capacity (lbs) (Rated for manual operation)	Overall Height (inches)	Swivel Lead (inches)	Base Caster Number+
XI	4	2	1000	5 5/8	1 3/16	120XI04201
	5	2	1000	6 1/2	1 3/8	120XI05201
	6	2	1000	7 1/2	1 9/16	120XI06201
	8	2	1000	9 1/2	2 1/4	120XI08201S-01

Phenolic (01 Stainless Steel Roller Bearing)*

Model	Wheel Diameter (inches)	Tread Width (inches)	Capacity (lbs) (Rated for manual operation)	Overall Height (inches)	Swivel Lead (inches)	Base Caster Number+
TM	4	2	800	5 5/8	1 3/16	120TM04201
	5	2	1000	6 1/2	1 3/8	120TM05201
	6	2	1200	7 1/2	1 9/16	120TM06201
	8	2	1200	9 1/2	2 1/4	120TM08201S-01

*Delrin (51) Bearings available. To order change "01" to other bearing code. Delrin example: 120TM06251.

Straight Sided Phenolic (01 Stainless Steel Roller Bearing)

Model	Wheel Diameter (inches)	Tread Width (inches)	Capacity (lbs) (Rated for manual operation)	Overall Height (inches)	Swivel Lead (inches)	Base Caster Number+
TH	4	2	800	5 5/8	1 3/16	120TH04201
	5	2	1000	6 1/2	1 3/8	120TH05201
	6	2	1200	7 1/2	1 9/16	120TH06201

+ For swivel models add "S", for rigid model add "R" to end of base caster number.

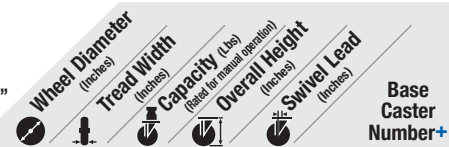

Solid Elastomer (01 Stainless Steel Roller Bearing)*

Model	Wheel Diameter (inches)	Tread Width (inches)	Capacity (lbs) (Rated for manual operation)	Overall Height (inches)	Swivel Lead (inches)	Base Caster Number+
SE	4	2	1000	5 5/8	1 3/16	120SE04201
	5	2	1200	6 1/2	1 3/8	120SE05201
	6	2	1200	7 1/2	1 9/16	120SE06201
	8	2	1200	9 1/2	2 1/4	120SE08201S-01

*Delrin (51) Bearings available. To order change "01" to other bearing code. Delrin example: 120SE06251.

Maxim® (01 Stainless Steel Roller Bearing)*

Model	Wheel Diameter (inches)	Tread Width (inches)	Capacity (lbs) (Rated for manual operation)	Overall Height (inches)	Swivel Lead (inches)	Base Caster Number+
NG	4	2	800	5 5/8	1 3/16	120NG04201
	5	2	1000	6 1/2	1 3/8	120NG05201
	6	2	1200	7 1/2	1 9/16	120NG06201
	8	2	1200	9 1/2	2 1/4	120NG08201S-01

Prevenz™ antimicrobial models available. Add PREV to end of model. *Bronze (22), Stainless Pedestal Precision (29), Annular Ball (31) and Delrin (51) bearings available. To order change "01" to other bearing code. Stainless Pedestal Precision example: 120NG04229.

White Nylon (01 Stainless Steel Roller Bearing)*

Model	Wheel Diameter (inches)	Tread Width (inches)	Capacity (lbs) (Rated for manual operation)	Overall Height (inches)	Swivel Lead (inches)	Base Caster Number+
NW	5	2	600	6 1/2	1 3/8	120NW05201
	6	2	900	7 1/2	1 9/16	120NW06201
	8	2	1100	9 1/2	2 1/4	120NW08201S-01

*Delrin (51) Bearings or plain bore (00) models available. To order change "01" to other bearing code. Delrin example: 120NW05251.

Glass Filled Polypropylene (01 Stainless Steel Roller Bearing)

Model	Wheel Diameter (inches)	Tread Width (inches)	Capacity (lbs) (Rated for manual operation)	Overall Height (inches)	Swivel Lead (inches)	Base Caster Number+
RT	4	2	800	5 5/8	1 3/16	120RT04201
	5	2	1000	6 1/2	1 3/8	120RT05201
	6	2	1200	7 1/2	1 9/16	120RT06201
	8	2	1200	9 1/2	2 1/4	120RT08201S-01

High Temp Glass Filled Nylon (01 Stainless Steel Roller Bearing)

Model	Wheel Diameter (inches)	Tread Width (inches)	Capacity (lbs) (Rated for manual operation)	Overall Height (inches)	Swivel Lead (inches)	Base Caster Number+
HT	4	2	800	5 5/8	1 3/16	120HT04201
	5	2	1000	6 1/2	1 3/8	120HT05201
	6	2	1200	7 1/2	1 9/16	120HT06201
	8	2	1200	9 1/2	2 1/4	120HT08201S-01

Prevenz™ Antimicrobial Wheels

The EPA registered and FDA compliant antimicrobial additive used in Prevenz™ wheels is designed to suppress the growth of a variety of destructive and odor causing microbes including bacteria, molds, mildew and fungi. To order add "PREV" to end of caster number.

XS Prevenz™ XR Prevenz™ XA Prevenz™ NG Prevenz™

THE POWER OF STAINLESS & PREVENZ™

THE SAFE SOLUTION.

How Does Prevenz™ Work?

The antimicrobial compound used in Prevenz™ wheels is designed to suppress the growth of a variety of destructive and odor causing microbes including bacteria, molds, mildew, and fungi. The active ingredients neutralize the ability of microbes to function, grow and reproduce.

How long does the protection last?

Prevenz™ is engineered to be effective against microbes for the life of the wheel. The agent remains stored in the polymer and is gradually released to the surface of the wheel.

Will scratches, tread wear or wax buildup diminish the effectiveness?

No. Prevenz™ protection is not a coating on the surface of the wheel. It is an integral part of the wheel material. Abrasion, chips or scratches will not impact the effectiveness of Prevenz™ in any way. Not even wax buildup on the wheel can impair the bacteria fighting performance.

Does Prevenz™ eliminate the need for cleaning?

No. Although Prevenz™ provides an added level of protection, these wheels do not eliminate the need for normal cleaning practices. They are designed to work in conjunction with and enhance your ongoing program. Good hygiene practices should always be observed.

Is Prevenz™ safe?

Yes. The active ingredients in Prevenz™ have undergone extensive laboratory testing and have been proven safe. The active ingredient has a history of hospital use for more than 30 years and is used in a broad range of popular personal care products, such as antimicrobial soap, toothpaste and deodorant. It is registered with the US Environmental Protection Agency (EPA), and products with this material have been approved by the US Food & Drug Administration (FDA), the European Union (EU), the National Sanitation Foundation (NSF) and other regulatory authorities around the world.

The EPA registered and FDA compliant antimicrobial additive used in Prevenz™ wheels is designed to suppress the growth of a variety of destructive and odor causing microbes including bacteria, molds, mildew and fungi. These wheels are suitable for a variety of applications including medical equipment, food equipment, pharmaceutical, chemical, meat & poultry, processing plants and more. To order add "PREV" to end of model number.

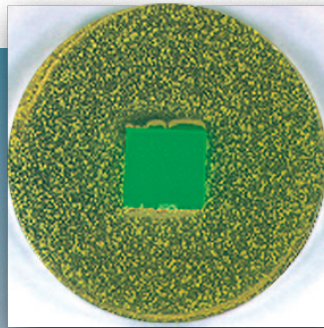

Without Prevenz™

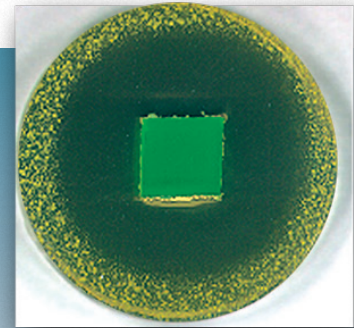

With Prevenz™

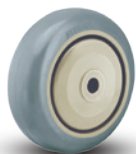

XA Prevenz™



XA Prevenz™
Heavy Duty



XS Prevenz™



XS Prevenz™
Heavy Duty



XR Prevenz™



XR Prevenz™
Heavy Duty



NG Prevenz™



Medical



Clean Industrial



Food Packaging and Processing



Beverage Industry



Pharmaceutical



Bakery Factory

COMBINE OUR STAINLESS OFFERING WITH PREVENZ™ WHEELS

TO HAVE THE BEST PROTECTION
AGAINST CORROSION AND
DESTRUCTIVE MICROBES.

05 SERIES WITH XA PREVENZ WHEEL

View our complete lineup of stainless
and Prevenz options Pages 77 – 86.

ALBION[®]
the caster experts



330

Contender™ Kingpinless Premium Stainless Steel

CAPACITY TO 3000



For your heaviest duty applications, the 330 Series features a thick precision machined premium grade 316 stainless swivel section and 304 stainless steel rig—both highly polished. Ideal for applications exposed to cleaning agents, washdowns, caustic solutions, steam, marine environments, or any other corrosive agents which could cause rust.

MOUNTING OPTIONS Standard Plate

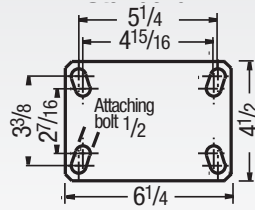

TYPICAL APPLICATIONS

- Food Processing
- Bakery Dough Troughs
- Stainless Carts
- Pharmaceuticals
- Laboratory
- Hospital Waste Management
- Marine
- Dollies

SWIVEL CROSS SECTION

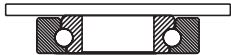

+ For swivel models add "S", for rigid model add "R" to end of base caster number.

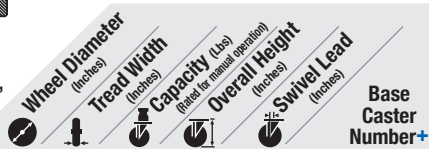

X-tra Soft Round Tread (01 Stainless Steel Roller Bearing)*

XR	10	2 1/2	850	11 1/2	2 1/4	330XR10401
*Stainless Precision Ball (28) bearings available. To order change "01" to "28". Stainless Precision example: 330XR10428.						

X-treme Plus Solid Poly. (28 Stainless Steel Ball Precision Bearing)*

XP	8	2 1/2	2000	10 1/8	2 1/16	330XP08428
	8	3	2000	10 1/8	2 1/16	330XP08528
	10	2 1/2	2500	11 1/2	2 1/4	330XP10428
	10	3	2500	11 1/2	2 1/4	330XP10528
*Stainless Roller (01) bearings available. To order change "28" to other bearing code. Stainless Roller example: 330XP08401.						



Stainless Steel



Premium Quality



Ergonomic



Environmentally Friendly



Towing^

FEATURES

- **Top Plate:** 5/16" 304 stainless steel welded inside and out to 316 stainless steel raceway for longer life
- **Swivel Section:** One row of 1/2" ball bearings mounted in a precision machined raceway. Zerk in swivel section
- **Yoke Base:** Notched 316 stainless steel
- **Legs:** 304 stainless steel welded inside and out
- **Axle:** 3/4" diameter
- **NSF:** Consult Factory
- Alternate or custom caster configurations available

BRAKE OPTIONS

Consult factory for stainless steel brakes.

BEARING OPTIONS



+ For swivel models add "S", for rigid model add "R" to end of base caster number.

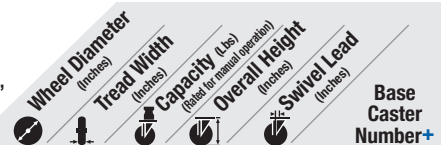

Polyurethane on Aluminum (01 Stainless Steel Roller Bearing)*

PD	8	2 1/2	2010	10 1/8	2 1/16	330PD08401
	8	3	2520	10 1/8	2 1/16	330PD08501
	10	2 1/2	2370	11 1/2	2 1/4	330PD10401
	10	3	3000	11 1/2	2 1/4	330PD10501
*Stainless Precision Ball (28) bearings available. To order change "01" to other bearing code. Stainless Precision example: 330PD10428.						

Phenolic (01 Stainless Steel Roller Bearing)*

TM	6	2 1/2	1600	7 1/2	1 3/8	330TM06401
	6	3	2000	7 1/2	1 3/8	330TM06501
	8	2 1/2	2000	10 1/8	2 1/16	330TM08401
	8	3	2500	10 1/8	2 1/16	330TM08501
	10	2 1/2	2500	11 1/2	2 1/4	330TM10401
	10	3	2900	11 1/2	2 1/4	330TM10501
	12	2 1/2	3000	13 1/2	2 1/16	330TM12401
	12	3	3000	13 1/2	2 1/16	330TM12501
*Stainless Precision Ball (28) bearings available. To order change "01" to "28". Stainless Precision example: 330TM06428.						

Heat Resistant Phenolic (01 Stainless Steel Roller Bearing)*

TR	6	3	2000	7 1/2	1 3/8	330TR06501
	8 <td>3 <td>2500</td> <td>10 1/8</td> <td>2 1/16</td> <th>330TR08501</th> </td>	3 <td>2500</td> <td>10 1/8</td> <td>2 1/16</td> <th>330TR08501</th>	2500	10 1/8	2 1/16	330TR08501
	10 <td>3</td> <td>2900</td> <td>11 1/2</td> <td>2 1/4</td> <th>330TR10501</th>	3	2900	11 1/2	2 1/4	330TR10501
	12 <td>3</td> <td>3000</td> <td>13 1/2</td> <td>2 1/16</td> <th>330TR12501</th>	3	3000	13 1/2	2 1/16	330TR12501
*Stainless Precision Ball (28) bearings available. To order change "01" to other bearing code. Stainless Precision example: 330TR06528.						

Trionix™ High Impact Polymer (28 Stainless Steel Precision Ball Bearing)

NX	6	2 1/2	3000	7 1/2	1 3/8	330NX06428
	6 <td>3 <td>3000</td> <td>7 1/2</td> <td>1 3/8</td> <th>330NX06528</th> </td>	3 <td>3000</td> <td>7 1/2</td> <td>1 3/8</td> <th>330NX06528</th>	3000	7 1/2	1 3/8	330NX06528
	8 <td>2 1/2</td> <td>3000</td> <td>10 1/8</td> <td>2 1/16</td> <th>330NX08428</th>	2 1/2	3000	10 1/8	2 1/16	330NX08428
	8 <td>3 <td>3000</td> <td>10 1/8</td> <td>2 1/16</td> <th>330NX08528</th> </td>	3 <td>3000</td> <td>10 1/8</td> <td>2 1/16</td> <th>330NX08528</th>	3000	10 1/8	2 1/16	330NX08528
	10	2 1/2	3000	11 1/2	2 1/4	330NX10428
	10	3	3000	11 1/2	2 1/4	330NX10528

E5

Medium Heavy Duty Stainless Steel Casters

CAPACITY TO 900



Constructed from 3/16" thick 304 stainless steel, the E5 Series is a more economical option for 2" wide wheel applications not needing the durability of the 05 Series or 120 Series. Ideal for applications exposed to cleaning agents, washdowns, caustic solutions, steam, marine environments, or other corrosive agents which could cause rust.

MOUNTING OPTIONS

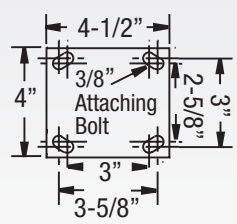

SWIVEL CROSS SECTION



TYPICAL APPLICATIONS

- Food Processing
- Bakery Dough Troughs
- Stainless Carts
- Pharmaceuticals
- Laboratory
- Hospital Waste Management
- Marine
- Dollies

Stainless Steel
 Economical
 Environmentally Friendly

FEATURES

- **Top Plate & Yoke:** Formed from 3/16" Type 304 stainless steel plate
- **Finish:** Stainless steel
- **Swivel Section:** Double stainless steel ball bearing raceways formed smooth for ease of swiveling
- **King Pin:** Stainless steel rivet
- **Axle:** 1/2" diameter, stainless steel hollow with roller bearing. Solid axle with Delrin and precision ball bearings
- **Legs:** 3/16" stainless steel formed for added strength welded to the yoke base
- **Spanner Bushing:** Type 304 Stainless Steel
- **Zerk Fitting:** Type 304 Stainless Steel
- **NSF:** Consult factory
- Alternate or custom caster configurations available

RIG OPTIONS

- Neoprene sealed swivel section specify **NS05**
- Notched seal kit. Specify **SD016001**

BRAKE OPTIONS

To order, add brake code below to end of model. Example: E5XS06201**SCB**

Stainless Steel Cam specify **CB**
Specify 1 Piece Delrin Bearing (52)



Face Specify **FBF**



Face Specify **FBG**

BEARING OPTIONS



Hand operated field installable swivel lock order **SL1200000** separately

Note: Wheel capacities can change with each bearing type. Consult factory.

+ For swivel models add "S", for rigid model add "R" to end of base caster number.

	Wheel Diameter (Inches)	Tread Width (Inches)	Capacity (Lbs) (Rated for manual operation)	Overall Height (Inches)	Swivel Lead (Inches)	Approx. Wt. (Lbs)	Base Caster Number+
--	-------------------------	----------------------	--	-------------------------	----------------------	-------------------	---------------------

X-tra Soft (Flat Tread) (01 Stainless Steel Roller Bearing)*

XS 	4	2	350	5 5/8	1 5/8	5 1/4	E5XS04201
	5	2	375	6 1/2	1 3/4	5 1/4	E5XS05201
	6	2	600	7 1/2	2 1/16	5 3/4	E5XS06201
	8	2	675	9 1/2	2 9/16	6	E5XS08201

Prevenz™ antimicrobial models available.
Add PREV to end of caster number.
*Delrin (51) Bearings available.
To order change "01" to other bearing code.
Delrin example: E5XS04251.

X-tra Soft (Round Tread) (01 Stainless Steel Roller Bearing)*

XR 	6	2	450	7 1/2	2 1/16	5 3/4	E5XR06201
	8	2	600	9 1/2	2 9/16	6	E5XR08201

Prevenz™ antimicrobial models available.
Add PREV to end of caster number.
*Delrin (51) Bearings available.
To order change "01" to other bearing code.
Delrin example: E5XR06251.

+ For swivel models add "S", for rigid model add "R" to end of base caster number.

	Wheel Diameter (Inches)	Tread Width (Inches)	Capacity (Lbs) (Rated for manual operation)	Overall Height (Inches)	Swivel Lead (Inches)	Approx. Wt. (Lbs)	Base Caster Number+
--	-------------------------	----------------------	--	-------------------------	----------------------	-------------------	---------------------

Polypropylene (01 Stainless Steel Roller Bearing)*

PB 	4	2	450	5 5/8	1 5/8	3 3/4	E5PB04201
	5	2	550	6 1/2	1 3/4	4 1/2	E5PB05201
	6	2	650	7 1/2	2 1/16	4 3/4	E5PB06201
	8	2	850	9 1/2	2 9/16	6 1/4	E5PB08201

*Delrin (51) Bearings available.
To order change "01" to other bearing code.
Delrin example: E5PB06251.

Retort High Temp Polypropylene (41 Plain Bore)

RW 	4	2	500	5 5/8	1 5/8	3 3/4	E5RW04241
	5	2	650	6 1/2	1 3/4	5 1/4	E5RW05241
	6	2	700	7 1/2	2 1/16	5 1/2	E5RW06241
	8	2	900	9 1/2	2 9/16	6 1/4	E5RW08241

Continue on next page >>

E5 SERIES • CAPACITY TO 900

STAINLESS STEEL

+ For swivel models add "S", for rigid model add "R" to end of base caster number.



Polyurethane on Polypropylene (01 Stainless Steel Roller Bearing)*

XA	Wheel Diameter (inches)	Tread Width (inches)	Capacity (Lbs) (Rate for manual operation)	Overall Height (inches)	Swivel Lead (inches)	Approx. Wt. (Lbs)	Base Caster Number+
	4	2	600	5 ⁵ / ₈	1 ⁵ / ₈	5	E5XA04201
	5	2	750	6 ¹ / ₂	1 ³ / ₄	5 ¹ / ₄	E5XA05201
	6	2	900	7 ¹ / ₂	2 ¹ / ₁₆	5 ³ / ₄	E5XA06201
	8	2	900	9 ¹ / ₂	2 ⁹ / ₁₆	7	E5XA08201

Prevenz™ antimicrobial models available. Add PREV to end of caster number.
*Delrin (51) Bearings available. To order change "01" to other bearing code. Delrin example: E5XA04251.

X-Treme™ Plus Solid Polyurethane (01 Stainless Steel Roller Bearing)*

XP	Wheel Diameter (inches)	Tread Width (inches)	Capacity (Lbs) (Rate for manual operation)	Overall Height (inches)	Swivel Lead (inches)	Approx. Wt. (Lbs)	Base Caster Number+
	4	2	900	5 ⁵ / ₈	1 ⁵ / ₈	4 ¹ / ₄	E5XP04201
	5	2	900	6 ¹ / ₂	1 ³ / ₄	5	E5XP05201
	6	2	900	7 ¹ / ₂	2 ¹ / ₁₆	5 ¹ / ₂	E5XP06201
	8	2	900	9 ¹ / ₂	2 ⁹ / ₁₆	6 ¹ / ₂	E5XP08201

*Bronze (22), Stainless Pedestal Precision (29), and Delrin (51) bearings available. To order change "01" to other bearing code. Stainless Pedestal Precision example: E5XP04229.

Solid Elastomer (01 Stainless Steel Roller Bearing)*

SE	Wheel Diameter (inches)	Tread Width (inches)	Capacity (Lbs) (Rate for manual operation)	Overall Height (inches)	Swivel Lead (inches)	Approx. Wt. (Lbs)	Base Caster Number+
	4	2	900	5 ⁵ / ₈	1 ⁵ / ₈	4 ¹ / ₄	E5SE04201
	5	2	900	6 ¹ / ₂	1 ³ / ₄	5	E5SE05201
	6	2	900	7 ¹ / ₂	2 ¹ / ₁₆	5 ¹ / ₂	E5SE06201
	8	2	900	9 ¹ / ₂	2 ⁹ / ₁₆	6 ¹ / ₂	E5SE08201

Delrin (51) bearings available. To order change "01" to other bearing code. Delrin example: E5SE04251.

Phenolic (01 Stainless Steel Roller Bearing)*

TM	Wheel Diameter (inches)	Tread Width (inches)	Capacity (Lbs) (Rate for manual operation)	Overall Height (inches)	Swivel Lead (inches)	Approx. Wt. (Lbs)	Base Caster Number+
	4	2	800	5 ⁵ / ₈	1 ⁵ / ₈	5	E5TM04201
	5	2	900	6 ¹ / ₂	1 ³ / ₄	5 ¹ / ₄	E5TM05201
	6	2	900	7 ¹ / ₂	2 ¹ / ₁₆	6 ¹ / ₄	E5TM06201
	8	2	900	9 ¹ / ₂	2 ⁹ / ₁₆	8	E5TM08201

*Delrin (51) Bearings available. To order change "01" to other bearing code. Delrin example: E5TM06251.

+ For swivel models add "S", for rigid model add "R" to end of base caster number.

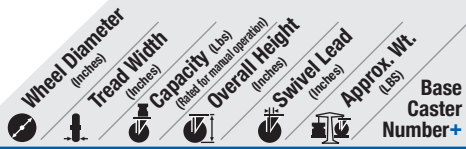

Maxim® (01 Stainless Steel Roller Bearing)*

NG	Wheel Diameter (inches)	Tread Width (inches)	Capacity (Lbs) (Rate for manual operation)	Overall Height (inches)	Swivel Lead (inches)	Approx. Wt. (Lbs)	Base Caster Number+
	4	2	800	5 ⁵ / ₈	1 ⁵ / ₈	5	E5NG04201
	5	2	900	6 ¹ / ₂	1 ³ / ₄	5 ¹ / ₄	E5NG05201
	6	2	900	7 ¹ / ₂	2 ¹ / ₁₆	5 ³ / ₄	E5NG06201
	8	2	900	9 ¹ / ₂	2 ⁹ / ₁₆	7	E5NG08201

Prevenz™ antimicrobial models available. Add PREV to end of caster number.
*Bronze (22), Stainless Pedestal Precision (29), and Delrin (51) bearings available. To order change "01" to other bearing code. Stainless Pedestal Precision example: E5NG04229.

White Nylon (01 Stainless Steel Roller Bearing)*

NW	Wheel Diameter (inches)	Tread Width (inches)	Capacity (Lbs) (Rate for manual operation)	Overall Height (inches)	Swivel Lead (inches)	Approx. Wt. (Lbs)	Base Caster Number+
	5	2	600	6 ¹ / ₂	1 ³ / ₄	5 ¹ / ₄	E5NW05201
	6	2	900	7 ¹ / ₂	2 ¹ / ₁₆	5 ³ / ₄	E5NW06201
	8	2	900	9 ¹ / ₂	2 ⁹ / ₁₆	6 ¹ / ₂	E5NW08201

*Delrin (51) Bearings available. To order change "01" to other bearing code. Delrin example: E5NW06251.

Glass Filled Polypropylene (01 Stainless Steel Roller Bearing)

RT	Wheel Diameter (inches)	Tread Width (inches)	Capacity (Lbs) (Rate for manual operation)	Overall Height (inches)	Swivel Lead (inches)	Approx. Wt. (Lbs)	Base Caster Number+
	4	2	800	5 ⁵ / ₈	1 ⁵ / ₈		E5RT04201
	5	2	900	6 ¹ / ₂	1 ³ / ₄		E5RT05201
	6	2	900	7 ¹ / ₂	2 ¹ / ₁₆		E5RT06201
	8	2	900	9 ¹ / ₂	2 ⁹ / ₁₆		E5RT08201

High Temp Glass Filled Nylon (01 Stainless Steel Roller Bearing)

HT	Wheel Diameter (inches)	Tread Width (inches)	Capacity (Lbs) (Rate for manual operation)	Overall Height (inches)	Swivel Lead (inches)	Approx. Wt. (Lbs)	Base Caster Number+
	4	2	800	5 ⁵ / ₈	1 ⁵ / ₈		E5HT04201
	5	2	900	6 ¹ / ₂	1 ³ / ₄		E5HT05201
	6	2	900	7 ¹ / ₂	2 ¹ / ₁₆		E5HT06201
	8	2	900	9 ¹ / ₂	2 ⁹ / ₁₆		E5HT08201

Prevenz™ Antimicrobial Wheels

The EPA registered and FDA compliant antimicrobial additive used in Prevenz™ wheels is designed to suppress the growth of a variety of destructive and odor causing microbes including bacteria, molds, mildew and fungi. To order add "PREV" to end of caster number.

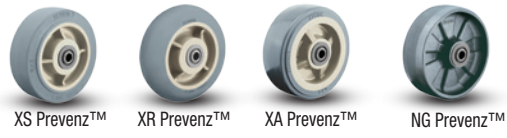

SPRING LOADED CASTERS

CAPACITY RANGE 500-3000 LBS

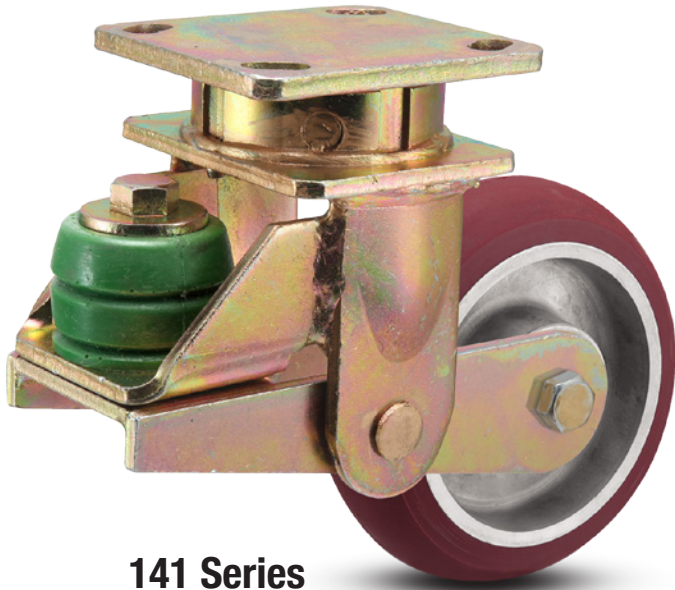

141 Series

Unique polyurethane spring design is durable and corrosion resistant.

Common Applications:

- Manufacturing Plant Carts
- Aerospace / Automotive
- Specialty Toolboxes
- Ground Support Equipment
- Technology Carts
- Portable Cranes & Hoists
- Mobile Workstations
- Monitoring Carts
- Laboratory Equipment

Kingpin Casters



40 Series Medium Duty
Capacity to 500 88-89



41 Series Medium Duty
Capacity to 800 90



42 Series Heavy Duty
Capacity to 800 91



44 Series Xtra Heavy Duty
Capacity to 1500 92

Kingpinless Casters



141 Series
Capacity to 1500 93



S310 Series
Capacity to 3000 94-95



S410 Series
Capacity to 3000 96-97



S610 Series
Capacity to 3000 98-99

Benefits of Spring Loaded Casters:

- Better floor and equipment protection
- Reduce operating noise
- Reduce unwanted vibration
- Increase product life expectancy

Need Even More Capacity Or A Custom Configuration?

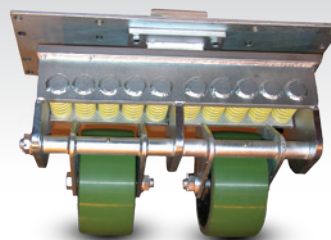

Excellent for Weight Carts
10,000 lbs load capacity!

You won't find this "bad boy" at just any caster source. Albion engineers and craftsmen can custom design and build a solution for even the most challenging applications.



Premium Quality



Environmentally Friendly

40

Medium Duty Spring-Loaded Kingpin Casters

CAPACITY TO 500



Designed with the load in mind, 40 series protects from damaging shocks or unwanted vibration and movement. Noise levels are reduced through the dampening effect of these casters.

TYPICAL APPLICATIONS

- Shock sensitive carts
- Aircraft jacks
- Monitoring equipment
- Material handling equipment

SWIVEL CROSS SECTION

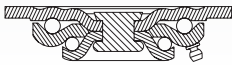

MOUNTING OPTION

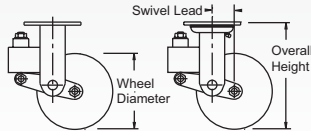
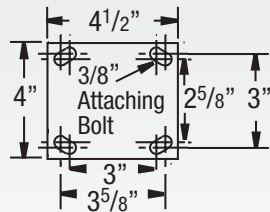

FEATURES

- **Load Springs:** Maximum rated capacity loads will deflect wheel approximately 3/8" (50%). Different load springs for each series permits wide variation in ride "softness." They can be preloaded to obtain various degrees of deflection
- **Top Plate & Yoke Base:** Made from 1/4" steel plate and unnotched
- **Swivel Section:** Cold formed, hardened double ball bearing raceways minimize ball indentation and wear
- **Legs:** 1/4" steel cold formed to increase strength and welded to the yoke base
- **King Bolt:** 5/8" diameter orbitally spun steel rivet
- **Axle:** 1/2" diameter hollow axle complete with lock nut. Axle is solid for 28 & 29 ball bearings
- **Wheel Seals:** Nylon seal retaining/thrust washers
- Alternate or custom caster configurations available

RIG OPTIONS

- Neoprene sealed swivel section specify **SS02**
- Hollow axle specify **ZF07**
- Available with **kingpinless** section, consult factory

BRAKE OPTIONS

- **Single Side and Double Sided Brakes** available, consult factory
- **Swivel Lock** available (welded), consult factory

BEARING OPTIONS



Note: Wheel capacities can change with each bearing type. Consult factory.

+ For swivel models add "S", for rigid model add "R" to end of base caster number.

	Wheel Diameter (inches)	Tread Width (inches)	Capacity (Lbs) (Rated for manual operation)	Overall Height (inches)	Swivel Lead (inches)	Approx. Wt. (Lbs)	Base Caster Number+
--	-------------------------	----------------------	---	-------------------------	----------------------	-------------------	---------------------

Neoprene on Aluminum (28 Precision Ball Bearing)

NP	5	2	500	8	13/4	10 1/2	40NP05228
	6	2	500	8 1/2	13/4	11	40NP06228
	8	2	500	10 1/2	13/4	13 1/4	40NP08228

Mold-on Rubber on Cast Iron (01 Roller Bearing)*

MR	5	2	450	8	13/4	10 1/2	40MR05201
	6 <th>2</th> <td>500</td> <td>8 1/2</td> <td>13/4</td> <td>11</td> <td>40MR06201</td>	2	500	8 1/2	13/4	11	40MR06201
	8 <th>2</th> <td>500</td> <td>10 1/2</td> <td>13/4</td> <td>13 1/4</td> <td>40MR08201</td>	2	500	10 1/2	13/4	13 1/4	40MR08201

*Industrial Ball (27) bearings available. To order change "01" to other bearing code. Industrial Ball example: 40MR05227.

Heavy Duty Moldon Rubber on Cast Iron (01 Roller Bearing)*

MH	5	2	500	8	13/4	10 1/2	40MH05201
	6 <th>2</th> <td>500</td> <td>8 1/2</td> <td>13/4</td> <td>11</td> <td>40MH06201</td>	2	500	8 1/2	13/4	11	40MH06201
	8 <th>2</th> <td>500</td> <td>10 1/2</td> <td>13/4</td> <td>13 1/4</td> <td>40MH08201</td>	2	500	10 1/2	13/4	13 1/4	40MH08201

*Industrial Ball (27) bearings available. To order change "01" to other bearing code. Industrial Ball example: 40MH05227.

+ For swivel models add "S", for rigid model add "R" to end of base caster number.

	Wheel Diameter (inches)	Tread Width (inches)	Capacity (Lbs) (Rated for manual operation)	Overall Height (inches)	Swivel Lead (inches)	Approx. Wt. (Lbs)	Base Caster Number+
--	-------------------------	----------------------	---	-------------------------	----------------------	-------------------	---------------------

Mold-on Rubber on Aluminum (01 Roller Bearing)*

MD	5	2	500	8	13/4	8	40MD05201
	6 <th>2</th> <td>500</td> <td>8 1/2</td> <td>13/4</td> <td>9</td> <td>40MD06201</td>	2	500	8 1/2	13/4	9	40MD06201
	8 <th>2</th> <td>500</td> <td>10 1/2</td> <td>13/4</td> <td>10 1/2</td> <td>40MD08201</td>	2	500	10 1/2	13/4	10 1/2	40MD08201

*Industrial Ball (27) bearings available. To order change "01" to other bearing code. Industrial Ball example: 40MD05227.

X-tra Soft Flat Tread (01 Roller Bearing)*

XS	5	2	500	8	13/4	8	40XS05201
	6 <th>2</th> <td>500</td> <td>8 1/2</td> <td>13/4</td> <td>8 1/2</td> <td>40XS06201</td>	2	500	8 1/2	13/4	8 1/2	40XS06201
	8 <th>2</th> <td>500</td> <td>10 1/2</td> <td>13/4</td> <td>9 1/2</td> <td>40XS08201</td>	2	500	10 1/2	13/4	9 1/2	40XS08201

Prevenz™ antimicrobial models available. Add PREV to end of caster number. *Industrial Ball (27) bearings available. To order change "01" to other bearing code. Industrial Ball example: 40XS05227.

Continue on next page >>

+ For swivel models add "S", for rigid model add "R" to end of base caster number.

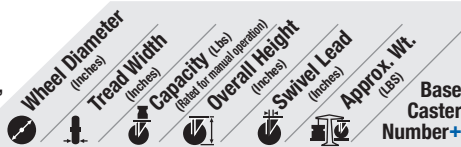

X-tra Soft Round Tread (01 Roller Bearing)*							
XR	6	2	450	8 1/2	1 3/4	8 1/2	40XR06201
	8	2	500	10 1/2	1 3/4	9 1/2	40XR08201

Prevenz™ antimicrobial models available. Add PREV to end of caster number.
 *Industrial Ball (27) bearings available. To order change "01" to other bearing code. Industrial Ball example: 40XR06227.

Monoprene Semi-Pneumatic Black (27 Industrial Ball Bearing)							
SZ	6	2	250	8 1/2	1 3/4	8 1/2	40SZ06227
	8	2	280	10 1/2	1 3/4	9 1/2	40SZ08227

Monoprene Semi-Pneumatic Grey (28 Precision Ball Bearing)							
SV	6	2	250	8 1/2	1 3/4	8 1/2	40SV06228
	8	2	280	10 1/2	1 3/4	9 1/2	40SV08228

Polyurethane on Aluminum Flat Tread (01 Roller Bearing)*							
PD	5	2	500	8	1 3/4	9	40PD05201
	6	2	500	8 1/2	1 3/4	8 3/4	40PD06201
	8	2	500	10 1/2	1 3/4	10	40PD08201

*Industrial Ball (27) bearings available. To order change "01" to other bearing code. Industrial Ball example: 40PD05227.

Polyurethane on Cast Iron (01 Roller Bearing)*							
PY	5	2	500	8	1 3/4	12 1/4	40PY05201
	6	2	500	8 1/2	1 3/4	12 3/4	40PY06201
	8	2	500	10 1/2	1 3/4	15 1/4	40PY08201

*Industrial Ball (27) bearings available. To order change "01" to other bearing code. Industrial Ball example: 40PY05227.

Polyurethane on Aluminum Round Tread (28 Precision Ball Bearing)							
AX	5	2	500	8	1 3/4	11	40AX05228
	6	2	500	8 1/2	1 3/4	12 1/2	40AX06228
	8	2	500	10 1/2	1 3/4	13	40AX08228

85 Shore A

Polyurethane on Aluminum Round Tread (28 Precision Ball Bearing)							
PM	5	2	500	8	1 3/4	11	40PM05228
	6	2	500	8 1/2	1 3/4	12 1/2	40PM06228
	8	2	500	10 1/2	1 3/4	13	40PM08228

95 Shore A

Polyurethane on Aluminum Round Tread (28 Precision Ball Bearing)							
PM 80A	5	2	500	8	1 3/4	11	40PM0522880A
	6	2	500	8 1/2	1 3/4	12 1/2	40PM0622880A
	8	2	500	10 1/2	1 3/4	13	40PM0822880A

80 Shore A To Specify Rigid or Swivel, insert "R" or "S" before "80A." Example: 40PM08228R80A.

Solid Elastomer (28 Precision Bearing)							
SE	5	2	500	8	1 3/4	7 1/4	40SE05228
	6	2	500	8 1/2	1 3/4	7 3/4	40SE06228
	8	2	500	10 1/2	1 3/4	9 1/4	40SE08228

+ For swivel models add "S", for rigid model add "R" to end of base caster number.

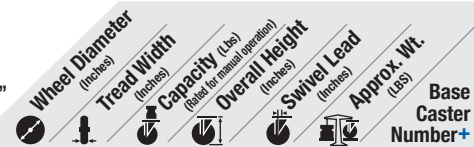

X-Treme™ Plus Solid Polyurethane (01 Roller Bearing)*							
XP	5	2	500	8	1 3/4	7 1/4	40XP05201
	6	2	500	8 1/2	1 3/4	7 3/4	40XP06201
	8	2	500	10 1/2	1 3/4	9 1/4	40XP08201

*Industrial Ball (27) bearings available. To order change "01" to other bearing code. Industrial Ball example: 40XP05227.

Maxim® (01 Roller Bearing)*							
NG	5	2	500	8	1 3/4	9	40NG05201
	6	2	500	8 1/2	1 3/4	9 1/2	40NG06201
	8	2	500	10 1/2	1 3/4	11 1/4	40NG08201

Prevenz™ antimicrobial models available. Add PREV to end of caster number.
 *Industrial Ball (27) bearings available. To order change "01" to other bearing code. Industrial Ball example: 40NG05227.

Trionix™ High Impact Polymer (28 Precision Ball Bearing)							
NX	5	2	500	8	1 3/4	12 1/4	40NX05228
	6	2	500	8 1/2	1 3/4	12 3/4	40NX06228
	8	2	500	10 1/2	1 3/4	15 1/4	40NX08228

White Nylon (01 Roller Bearing)							
NW	5	2	500	8	1 3/4		40NW05201
	6	2	500	8 1/2	1 3/4		40NW06201
	8	2	500	10 1/2	1 3/4		40NW08201

Glass Filled Polypropylene (01 Roller Bearing)							
RT	5	2	500	8	1 3/4		40RT05201
	6	2	500	8 1/2	1 3/4		40RT06201
	8	2	500	10 1/2	1 3/4		40RT08201

Heavy Duty Glass Filled Nylon (01 Roller Bearing)							
DT	5	2	500	8	1 3/4		40DT05201
	6	2	500	8 1/2	1 3/4		40DT06201
	8	2	500	10 1/2	1 3/4		40DT08201

Prevenz™ Antimicrobial Wheels

The EPA registered and FDA compliant antimicrobial additive used in Prevenz™ wheels is designed to suppress the growth of a variety of destructive and odor causing microbes including bacteria, molds, mildew and fungi. To order add "PREV" to end of caster number.

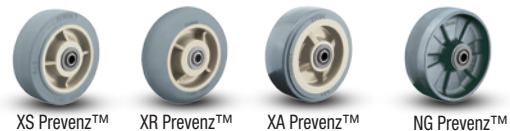

41

SpringGuard™ Spring-Loaded Kingpin Casters CAPACITY TO 800



Spring into safety with this clever spring loaded caster featuring SpringGuard™, which is well suited for the automotive and aviation industries. The spring is not exposed; instead it is protected by a urethane guard for additional safety.

MOUNTING OPTION

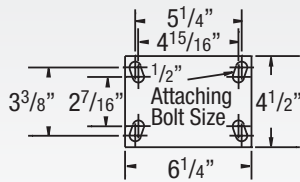

TYPICAL APPLICATIONS

- Diagnostic and electrical
- Institutional and laboratory
- Medical equipment and carts
- Food processing
- Mobile workstations and storage racks
- Automotive seat racks
- Ground support equipment
- Packaging equipment
- Specialty toolboxes
- Tilt carts



Premium Quality



Environmentally Friendly



Towing^

FEATURES

- **Load Springs:** Springs are encapsulated and protected by a urethane SpringGuard™ for added safety, plus noise and vibration reduction
- **Swivel Section:** Fully heat treated double ball raceway construction, extends the life of the caster
- **Swivel Lead:** Longer swivel lead allows the caster to index quicker into in-line position for easier movement.
- **Top Plate & Yoke Base:** Top plate and legs are made from 1/4" thick cold formed steel

RIG OPTIONS

- Hollow axle specify **ZF07**

BRAKE OPTIONS

Consult Factory

BEARING OPTION



Precision
Ball (28)

Spring Deflection Curve

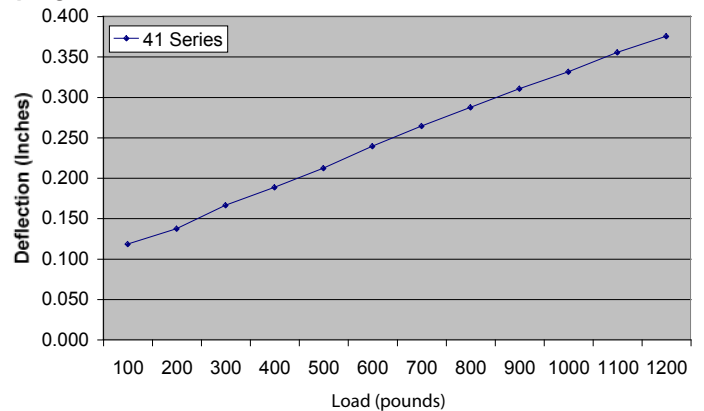

Linear deflection curve demonstrates consistent smooth spring action with loads from 100 lbs. to 1200 lbs.

+ For swivel models add "S", for rigid model add "R" to end of base caster number.

	Wheel Diameter (Inches)	Tread Width (Inches)	Capacity (Lbs) (rated for normal operation)	Overall Height (Inches)	Swivel Lead (Inches)	Approx. Wt. (LBS)	Base Caster Number+
41 Aubin Industries Swivel-EAZ® Crown Tread (Blue Tread with (28) Precision Bearing)	6	2	800	77/8	2		41EY06228S



	Wheel Diameter (Inches)	Tread Width (Inches)	Capacity (Lbs) (rated for normal operation)	Overall Height (Inches)	Swivel Lead (Inches)	Approx. Wt. (LBS)	Base Caster Number+
41 Aubin Industries Swivel-EAZ® Flat Tread (Blue Tread with (28) Precision Bearing)	6	2	800	77/8	2		41EZ06228S



	Wheel Diameter (Inches)	Tread Width (Inches)	Capacity (Lbs) (rated for normal operation)	Overall Height (Inches)	Swivel Lead (Inches)	Approx. Wt. (LBS)	Base Caster Number+
41 Series Polyurethane on Aluminum 90A Durometer (Green Tread with (28) Precision Bearing)	6	2	800	77/8	2		41PM06228S



+ For swivel models add "S", for rigid model add "R" to end of base caster number.

	Wheel Diameter (Inches)	Tread Width (Inches)	Capacity (Lbs) (rated for normal operation)	Overall Height (Inches)	Swivel Lead (Inches)	Approx. Wt. (LBS)	Base Caster Number+
41 Series Polyurethane on Aluminum 80A Durometer (Butterscotch Tread with (28) Precision Bearing)	6	2	800	77/8	2		41PM06228S80A



	Wheel Diameter (Inches)	Tread Width (Inches)	Capacity (Lbs) (rated for normal operation)	Overall Height (Inches)	Swivel Lead (Inches)	Approx. Wt. (LBS)	Base Caster Number+
41 Series X-tra Soft Rubber (Flat Tread with (28) Precision Bearing)	6	2	600	77/8	2		41XS06228S



	Wheel Diameter (Inches)	Tread Width (Inches)	Capacity (Lbs) (rated for normal operation)	Overall Height (Inches)	Swivel Lead (Inches)	Approx. Wt. (LBS)	Base Caster Number+
41 Series (Solid Elastomer (28) Precision Bearing)	6	2	800	77/8	2		41SE06228S





Premium Quality



Environmentally Friendly

42

Heavy Duty Spring-Loaded Kingpin Casters

CAPACITY TO 800



Designed with greater load capacity than our 40 series, this series protects from damaging shocks or unwanted vibration and movement. Noise levels are reduced through the dampening effect of these casters.

MOUNTING OPTION

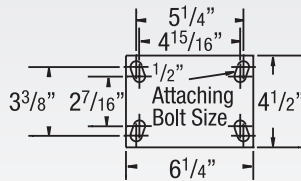

SWIVEL CROSS SECTION

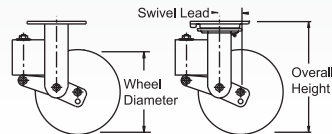
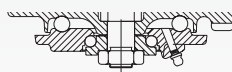

TYPICAL APPLICATIONS

- Shock sensitive carts
- Aircraft jacks
- Monitoring equipment
- Material handling equipment
- Computer equipment

+ For swivel models add "S", for rigid model add "R" to end of base caster number.

Wheel Diameter (Inches)	Tread Width (Inches)	Capacity (Lbs) (Based on normal operation)	Overall Height (Inches)	Swivel Lead (Inches)	Approx. Wt. (Lbs)	Base Caster Number+
-------------------------	----------------------	--	-------------------------	----------------------	-------------------	---------------------

Moldon Rubber on Cast Iron (07 Roller Bearing)

MR	8	2 1/2	800	11 1/2	2 1/4	22 1/2	42MR08407
	10	2 1/2	800	13 1/2	2 1/4	26 1/2	42MR10407

Pneumatic (28 Precision Ball Bearing)

SF	8	2.80/4	295	11 1/2	2 1/4	19 3/4	42SF08528
	10 <th>4.10/4</th> <th>350</th> <th>13 1/2</th> <th>2 1/4</th> <th>21</th> <th>42SF10628</th>	4.10/4	350	13 1/2	2 1/4	21	42SF10628

Polyurethane on Cast Iron (07 Roller Bearing)*

PY 80A	8	2 1/2	800	11 1/2	2 1/4	23	42PY0840780A
	10 <th>2 1/2</th> <th>800</th> <th>13 1/2</th> <th>2 1/4</th> <th>19 1/2</th> <th>42PY1040780A</th>	2 1/2	800	13 1/2	2 1/4	19 1/2	42PY1040780A

To Specify Rigid or Swivel, insert "R" or "S" before "80A."
Ex: 42PY08407R80A.

FEATURES

- **Load Springs:** Maximum rated capacity loads will deflect wheel approximately 5/8" (50%). Different load springs for each series permits wide variation in ride "softness." They can be preloaded to obtain various degrees of deflection Top
- **Top Plate & Yoke Base:** AISI 1045 drop forged steel for extended service life
- **Swivel Section:** Double ball bearing with coined "deep-groove" load and machined thrust raceways provide optimal performance under extreme loads
- **Legs:** 1/4" steel, formed to increase strength
- **King Bolt:** 3/4" diameter heat treated bolt and nut for enhanced shock load capacity
- **Axle:** 1/2" diameter hollow axle with lock nut for easy lubrication of wheels with straight roller bearing. Solid axle for 28 ball bearing
- **Lubrication:** Zerk fitting in swivel section and in recessed head of hollow axle
- Alternate or custom caster configurations available

RIG OPTIONS

- Neoprene sealed swivel section specify **SS05**
- Available with **kingpinless** section, consult factory

BRAKE OPTIONS

- **Single Side and Double Sided** Brakes available, consult factory
- **Swivel Lock** available (welded), consult factory

BEARING OPTIONS

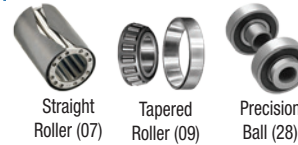

+ For swivel models add "S", for rigid model add "R" to end of base caster number.

Wheel Diameter (Inches)	Tread Width (Inches)	Capacity (Lbs) (Based on normal operation)	Overall Height (Inches)	Swivel Lead (Inches)	Approx. Wt. (Lbs)	Base Caster Number+
-------------------------	----------------------	--	-------------------------	----------------------	-------------------	---------------------

Polyurethane on Cast Iron (07 Roller Bearing)

PY	8	2 1/2	800	11 1/2	2 1/4	23	42PY08407
	10	2 1/2	800	13 1/2	2 1/4	19 1/2	42PY10407

Vulkollan on Iron (07 Roller Bearing)

VY	8	2 1/2	800	11 1/2	2 1/4	23	42VY08407
	10	2 1/2	800	13 1/2	2 1/4	21 1/4	42VY10407

Phenolic (07 Roller Bearing)*

TM	8	2 1/2	800	11 1/2	2 1/4	23	42TM08407
	10	2 1/2	800	13 1/2	2 1/4	21 1/4	42TM10407

*Tapered Roller (09) bearing available. To order change "07" to other bearing code. Example: 42TM08409.

Trionix™ High Impact Polymer (28 Precision Ball Bearing)

NX	8	2 1/2	800	11 1/2	2 1/4		42NX08428
	10	2 1/2	800	13 1/2	2 1/4		42NX10428

42 SERIES • CAPACITY TO 800

SPRING LOADED



Premium Quality



Environmentally Friendly

44

Xtra Heavy Duty Spring-Loaded Kingpin Casters CAPACITY TO 1500



Designed with greater load capacity than our 40, 41, and 42 series, this series protects from damaging shocks or unwanted vibration and movement. Noise levels are reduced through the dampening effect of these casters.

MOUNTING OPTION

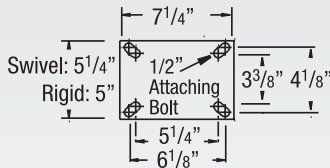

SWIVEL CROSS SECTION

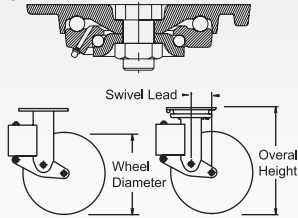

TYPICAL APPLICATIONS

- Aircraft tripod jacks
- Portable medical equipment
- Computer equipment
- Shock sensitive loads

FEATURES

- **Load Springs:** Maximum rated capacity loads will deflect wheel approximately 3/4". Different load springs permit wide variation in ride "softness." They can be preloaded to obtain various degrees of deflection
- **Swivel Top Plate:** AISI 1045 drop forged steel for strength & reliability
- **Yoke Base:** AISI 1045 drop forged steel with machined raceway affords extreme wear and greater capacity
- **Swivel Section:** Swivel load bearing is 4" diameter deep grooved load raceway with 1/2" steel balls and the thrust race is 2-5/8" diameter using 3/8" diameter steel balls for maximum performance under extreme loads
- **Legs:** 3/8" steel plate, welded inside and out to the yoke base to handle side impacts
- **King Bolt:** 1" diameter bolt and nut heat-treated for maximum performance
- **Axle:** 3/4" diameter solid axle with lock nut

RIG OPTIONS

- **Neoprene sealed** swivel section specify **SS07**
- **Lubrication:** Zerk fitting in swivel section and in wheel hub for extended bearing life
- Available with **kingpinless** section, consult factory.
- Alternate or custom caster configurations available

BRAKE OPTIONS

Single Side and Double Sided Brakes available, consult factory

Swivel Lock available (welded), consult factory

BEARING OPTIONS



+ For swivel models add "S", for rigid model add "R" to end of base caster number.

Wheel Diameter (Inches)	Tread Width (Inches)	Capacity (Lbs) (Rate for manual operation)	Overall Height (Inches)	Swivel Lead (Inches)	Approx. Wt. (Lbs)	Base Caster Number+
-------------------------	----------------------	---	-------------------------	----------------------	-------------------	---------------------

Moldon Rubber on Cast Iron (01 Roller Bearing)*

MR	Wheel Diameter	Tread Width	Capacity	Overall Height	Swivel Lead	Approx. Wt.	Base Caster Number
	10	3	1000	13 1/2	3	42 1/2	44MR10501
	12	3	1200	15 1/2	3	47 1/2	44MR12501

*Tapered Roller (09) bearing available. To order change "01" to other bearing code. Example: 44MR10509.

Pneumatic (01 Roller Bearing)*

SF	Wheel Diameter	Tread Width	Capacity	Overall Height	Swivel Lead	Approx. Wt.	Base Caster Number
	12	4.10/6	445	17 1/2	4 1/2	40	44SF12701
	14	5.30/6	785	18 1/2	4 1/2	43	44SF14801
	16	4.80/6	1000	19 1/2	4 1/2	45 3/4	44SF16801

*Tapered Roller (09) bearing available. To order change "01" to other bearing code. Example: 44SF10509.

Polyurethane on Cast Iron (01 Roller Bearing)*

PY	Wheel Diameter	Tread Width	Capacity	Overall Height	Swivel Lead	Approx. Wt.	Base Caster Number
	10	3	1500	13 1/2	3	48 1/2	44PY10501
	12	3	1500	15 1/2	3	56 1/4	44PY12501

*Tapered Roller (09) bearing available. To order change "01" to other bearing code. Example: 44PY10509.

Polyurethane on Cast Iron (01 Roller Bearing)*

PY 80A	Wheel Diameter	Tread Width	Capacity	Overall Height	Swivel Lead	Approx. Wt.	Base Caster Number
	10	3	1500	13 1/2	3	48 1/2	44PY1050180A
	12	3	1500	15 1/2	3	56 1/4	44PY1250180A

To Specify Rigid or Swivel, insert "R" or "S" before "80A". Example: 42PY08228R80A.

*Tapered Roller (09) bearing available.

To order change "01" to other bearing code. Example: 44PY1050980A.

Vulkollan on Cast Iron (01 Roller Bearing)*

VY	Wheel Diameter	Tread Width	Capacity	Overall Height	Swivel Lead	Approx. Wt.	Base Caster Number
	10	3	1500	13 1/2	3	48 1/2	44VY10501
	12	3	1500	15 1/2	3	56 1/4	44VY12501

*Tapered Roller (09) bearing available. To order change "01" to other bearing code. Example: 44VY10509.

X-Treme™ Plus Solid Polyurethane (01 Roller Bearing)*

XP	Wheel Diameter	Tread Width	Capacity	Overall Height	Swivel Lead	Approx. Wt.	Base Caster Number
	10	3	1500	13 1/2	3	35	44XP10501

*Tapered Roller (09) and Precision Ball (28) bearings available. To order change "01" to other bearing code. Example: 44XP10509.

Trionix™ High Impact Polymer (28 Precision Ball Bearing)*

NX	Wheel Diameter	Tread Width	Capacity	Overall Height	Swivel Lead	Approx. Wt.	Base Caster Number
	10	3	1500	13 1/2	3	35	44NX10528

*Tapered Roller (09) bearing available. To order change "01" to other bearing code. Example: 44NX10509.

Polyurethane on Aluminum (Flat Tread) (28 Precision Ball Bearing)*

PD	Wheel Diameter	Tread Width	Capacity	Overall Height	Swivel Lead	Approx. Wt.	Base Caster Number
	10	2 1/2	1500	13 1/2	3	38 1/2	44PD10428

*Tapered Roller (09) bearing available. To order change "01" to other bearing code. Example: 44PD10509.

141

Kingpinless Contender Poly Spring Casters

CAPACITY TO 1500

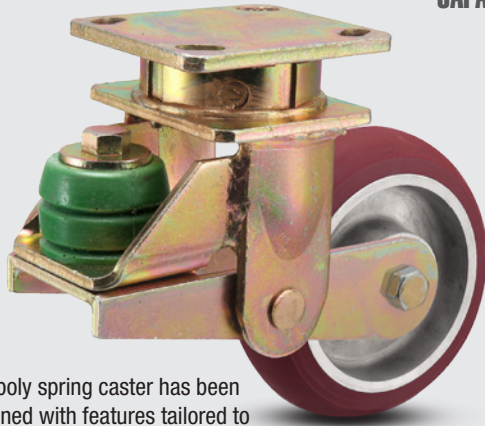

This poly spring caster has been designed with features tailored to meet the varied needs of the aviation ground support equipment and automotive industries. 141 series are equally at home in other extremely abusive and rugged applications.

TYPICAL APPLICATIONS

- Aircraft tripod jacks
- Portable medical equipment, computer equipment
- Any shock sensitive load
- Automotive seat racks
- Tilt carts
- Heavy duty toolboxes

MOUNTING OPTION

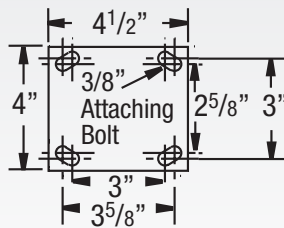

SWIVEL CROSS SECTION

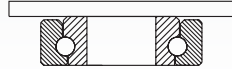

+ For rigid model change "S" to "R" at end of base caster number.

Neoprene on Aluminum (28 Precision Ball Bearing)

NP	Wheel Diameter (Inches)	Tread Width (Inches)	Capacity (Lbs) (Rated for normal operation)	Overall Height (Inches)	Swivel Lead (Inches)	Base Caster Number+
	5	2	600	7 1/2	3	141NP05228S
	6	2	700	8	3	141NP06228S
	8	2	700	10 1/8	3	141NP08228S

Polyurethane on Aluminum (28 Precision Ball Bearing)

AX	Wheel Diameter (Inches)	Tread Width (Inches)	Capacity (Lbs) (Rated for normal operation)	Overall Height (Inches)	Swivel Lead (Inches)	Base Caster Number+
	5	2	1000	7 1/2	3	141AX05228S
	6	2	1250	8	3	141AX06228S
	8	2	1500	10 1/8	3	141AX08228S

85 Shore A

Polyurethane on Durometer (28 Precision Ball Bearing)

PM 80A	Wheel Diameter (Inches)	Tread Width (Inches)	Capacity (Lbs) (Rated for normal operation)	Overall Height (Inches)	Swivel Lead (Inches)	Base Caster Number+
	5	2	1000	7 1/2	3	141PM05228S80A
	6	2	1250	8	3	141PM06228S80A
	8	2	1500	10 1/8	3	141PM08228S80A

80 Shore A



Premium Quality



Towing^

FEATURES

- Protects cargo from damaging shocks and unwanted vibration
- Unique polyurethane spring design is durable and corrosion resistant
- Solid spring material features no spring coil where debris can jam spring action
- Yellow Dichromate finish is attractive and features better corrosion resistance compared to zinc plating
- Quiet rolling, rugged kingpinless caster rig
- 5", 6" and 8" wheel diameters available to meet overall load height and application requirements
- Longer swivel lead allows the caster to index quicker into in-line position for easier movement

RIG OPTION

- Swivel lock available, consult factory

BEARING OPTIONS



(28) Precision Ball

The 141's unique polyurethane spring design is durable and corrosion resistant

+ For rigid model change "S" to "R" at end of base caster number.

Wheel Diameter (Inches)	Tread Width (Inches)	Capacity (Lbs) (Rated for normal operation)	Overall Height (Inches)	Swivel Lead (Inches)	Base Caster Number+
-------------------------	----------------------	--	-------------------------	----------------------	---------------------

Polyurethane on Aluminum (28 Precision Ball Bearing)

PM	Wheel Diameter (Inches)	Tread Width (Inches)	Capacity (Lbs) (Rated for normal operation)	Overall Height (Inches)	Swivel Lead (Inches)	Base Caster Number+
	5	2	1000	7 1/2	3	141PM05228S
	6	2	1250	8	3	141PM06228S
	8	2	1500	10 1/8	3	141PM08228S

95 Shore A

Solid Elastomer (28 Precision Ball Bearing)

SE	Wheel Diameter (Inches)	Tread Width (Inches)	Capacity (Lbs) (Rated for normal operation)	Overall Height (Inches)	Swivel Lead (Inches)	Base Caster Number+
	5	2	1000	7 1/2	3	141SE05228S
	6	2	1100	8	3	141SE06228S
	8	2	1200	10 1/8	3	141SE08228S

X-tra Soft Rubber Flat Tread (28 Precision Ball Bearing)

XS	Wheel Diameter (Inches)	Tread Width (Inches)	Capacity (Lbs) (Rated for normal operation)	Overall Height (Inches)	Swivel Lead (Inches)	Base Caster Number+
	5	2	500	7 1/2	3	141XS05228S
	6	2	600	8	3	141XS06228S
	8	2	675	10 1/8	3	141XS08228S

X-tra Soft Rubber Round Tread (28 Precision Ball Bearing)

XR	Wheel Diameter (Inches)	Tread Width (Inches)	Capacity (Lbs) (Rated for normal operation)	Overall Height (Inches)	Swivel Lead (Inches)	Base Caster Number+
	6	2	450	8	3	141XR06228S
	8	2	600	10 1/8	3	141XR08228S

Magnum Polyurethane on Aluminum Round Tread (28 Prec. Ball Bearing)

UA	Wheel Diameter (Inches)	Tread Width (Inches)	Capacity (Lbs) (Rated for normal operation)	Overall Height (Inches)	Swivel Lead (Inches)	Base Caster Number+
	6	2	750	8	3	141UA06228S
	8	2	900	10 1/8	3	141UA08228S

UA Red	UA Orange	UA Black
Shore 80A	Shore 73D	Shore 70A
6"=500 capacity 8"=800 capacity	6"=1,000 capacity 8"=1,200 capacity	6"=410 capacity 8"=500 capacity

To order color/durometer enter durometer code at end of model. Red wheel example: 141UA08228S80A. To specify Rigid or Swivel, insert "R" or "S" before last 3 digit durometer code. Ex: 141UA08228R80A.

^Towing: Consult factory prior to ordering to ensure selection supports your towing requirement

141 SERIES • CAPACITY TO 1500

SPRING LOADED

S310 Contender Spring Loaded Kingpinless Casters

CAPACITY TO 3000



Designed from high quality, heat treated AISI 1045 stamped steel. Zinc plating delivers greater corrosion resistance than paint. Inside and outside welds deliver superior strength.

Great capacity and shock protection. Noise levels are reduced through the dampening effect of these casters.

Capacities listed at 50% of wheel deflection (21/32"). Total wheel deflection is 1-5/16".

MOUNTING OPTIONS Standard Plate

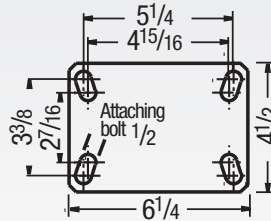

Special Order Plates

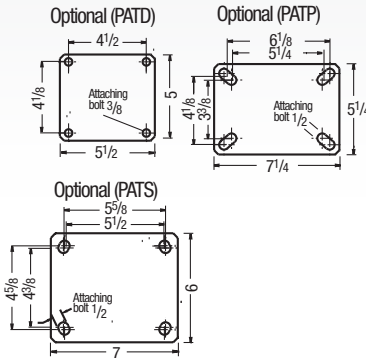

TYPICAL APPLICATIONS

- Conveyor-drawn tow-trucks
- Heavy duty bakery racks
- Production dollies
- Heavy duty dough troughs
- Aviation Ground Support
- Aircraft Tripod Jacks
- Shock Sensitive Loads

SWIVEL CROSS SECTION

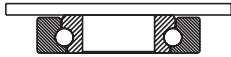

+ For swivel models add "S", for rigid model add "R" to end of base caster number.

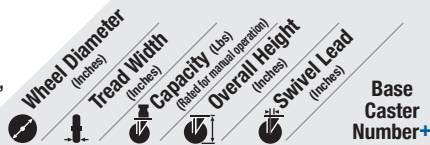

Molded Rubber on Cast Iron (09 Tapered Roller Bearing)*

MR/MH	Wheel Diameter (inches)	Tread Width (inches)	Capacity (lbs)	Overall Height (inches)	Swivel Lead (inches)	Base Caster Number+
	6	2 1/2	700	10 7/8	4 7/8	S310MR06409
	6	3	750	10 7/8	4 7/8	S310MR06509
	8	2 1/2	850	11 7/8	4 7/8	S310MR08409
	8	3	900	11 7/8	4 7/8	S310MR08509
	10	2 1/2	950	14	4 7/8	S310MR10409
	10	2 1/2**	1500	14	4 7/8	S310MH10409
	10	3	1000	14	4 7/8	S310MR10509
	10	3**	1800	14	4 7/8	S310MH10509
	12	2 1/2	950	16	5 11/16	S310MR12409
	12	2 1/2**	1700	16	5 11/16	S310MH12409
	12	3	1200	16	5 11/16	S310MR12509

*Roller (01) bearings available. To order change "09" to "01". Example: S310MR10401.

**Heavy-duty MH version of wheel.



Premium Quality



Environmentally Friendly



Towing^

FEATURES

- **Load Springs:** Protect from damaging shocks and reduce noise levels through the dampening effect of the springs
- **Top Plate:** 5/16" AISI 1045 heat treated steel welded inside and out for longer life
- **Swivel Section:** One row of 1/2" ball bearings mounted in a heat treated precision machined raceway. Zerk in swivel section
- **Yoke Base:** Notched AISI 1045 heat treated steel
- **Legs:** welded inside and out
- **Axle:** 3/4" diameter
- **Finish:** Zinc plating
- Alternate or custom caster configurations available

RIG OPTIONS

- For non-spring loaded versions, see 310 Series on pages 48-49
- 310 Optional Plates also available, consult factory

BRAKE OPTIONS

Consult factory

+ For swivel models add "S", for rigid model add "R" to end of base caster number.

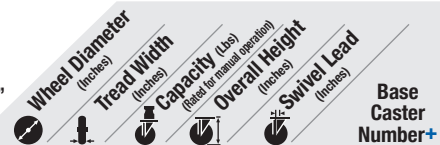

Mold-on Polyurethane on Aluminum (01 Roller Bearing)*

PD	Wheel Diameter (inches)	Tread Width (inches)	Capacity (lbs)	Overall Height (inches)	Swivel Lead (inches)	Base Caster Number+
	8	2 1/2	2010	11 7/8	4 7/8	S310PD08401
	8	3	2520	11 7/8	4 7/8	S310PD08501
	10	2 1/2	2370	14	4 7/8	S310PD10401
	10	3	3000	14	4 7/8	S310PD10501

Standard durometer 60 Shore D. Other durometers available.
*Tapered Roller (09) bearings available. To order change "01" to "09".
Example: S310PD10409.

Polyurethane on Cast Iron (09 Tapered Roller Bearing)*

PY	Wheel Diameter (inches)	Tread Width (inches)	Capacity (lbs)	Overall Height (inches)	Swivel Lead (inches)	Base Caster Number+
	6	2 1/2	1600	10 7/8	4 7/8	S310PY06409
	6	3	2000	10 7/8	4 7/8	S310PY06509
	8	2 1/2	2000	11 7/8	4 7/8	S310PY08409
	8	3	2500	11 7/8	4 7/8	S310PY08509
	10	2 1/2	2300	14	4 7/8	S310PY10409
	10	3	3000	14	4 7/8	S310PY10509
	12	2 1/2	2700	16	5 11/16	S310PY12409
	12	3	3000	16	5 11/16	S310PY12509

95 Shore A

80 Shore A

*Roller (01) bearings available. To order change "09" to "01".
Example: S310PY10401.

80A Durometer available, add "80A" to end of caster number.
80A capacity reduced by approximately 20%.
Swivel example: S310PY06409S80A.
For 70D consult factory.

Thick Tread Polyurethane (09 Tapered Roller Bearing)*

PX	Wheel Diameter (inches)	Tread Width (inches)	Capacity (lbs)	Overall Height (inches)	Swivel Lead (inches)	Base Caster Number+
	6	3	2250	10 7/8	4 7/8	S310PX06509
	8	3	2780	11 7/8	4 7/8	S310PX08509
	10	2 1/2	2600	14	4 7/8	S310PX10409
	10	3	3000	14	4 7/8	S310PX10509
	12	3	3000	16	5 11/16	S310PX12509

Standard durometer 95 Shore A. Other durometers available.
*Roller (01) bearings available. To order change "09" to "01".
Example: S310PX10401.

+ For swivel models add "S", for rigid model add "R" to end of base caster number.

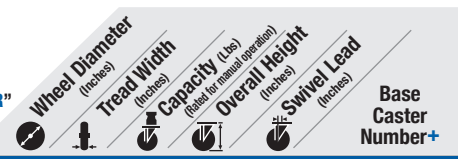

Aubin Industries Swivel-EAZ® Crown Tread (28 Prec. Ball Bearing)

Model	Wheel Diameter (inches)	Tread Width (inches)	Capacity (lbs)	Overall Height (inches)	Swivel Lead (inches)	Base Caster Number+
EY	6	3	2137	107/8	47/8	S310EY06528
	8	3	3000	117/8	47/8	S310EY08528

Standard durometer 95 Shore A. Other durometers available.

Aubin Industries Swivel-EAZ® Flat Tread (28 Prec. Ball Bearing)

Model	Wheel Diameter (inches)	Tread Width (inches)	Capacity (lbs)	Overall Height (inches)	Swivel Lead (inches)	Base Caster Number+
EZ	6	3	2850	107/8	47/8	S310EZ06528
	8	3	3000	117/8	47/8	S310EZ08528
	10	3	3000	14	47/8	S310EZ10528

Standard durometer 95 Shore A. Other durometers available.

Polyurethane on Heavy Duty Cast Iron (28 Precision Ball Bearing)*

Model	Wheel Diameter (inches)	Tread Width (inches)	Capacity (lbs)	Overall Height (inches)	Swivel Lead (inches)	Base Caster Number+
PF	6	2 1/2	2900	107/8	47/8	S310PF06428
	8	2 1/2	3000	117/8	47/8	S310PF08428
	8	3	3000	117/8	47/8	S310PF08528
	10	3	3000	14	47/8	S310PF10528

95 Shore A

*Tapered Roller (09) bearings available. To order change "28" to "09". Example: S310PF10509.

Polyurethane Reactive on Iron (28 Precision Ball Bearing)*

Model	Wheel Diameter (inches)	Tread Width (inches)	Capacity (lbs)	Overall Height (inches)	Swivel Lead (inches)	Base Caster Number+
PR	10	3	2400	14	47/8	S310PR10528
	12	3	2800	16	5 11/16	S310PR12528

80 Shore A

*Tapered Roller (09) bearings available. To order change "28" to "09". Example: S310PR10509.

Vulkollan on Cast Iron (09 Tapered Roller Bearing)*

Model	Wheel Diameter (inches)	Tread Width (inches)	Capacity (lbs)	Overall Height (inches)	Swivel Lead (inches)	Base Caster Number+
VY	6	2 1/2	2350	107/8	47/8	S310VY06409
	8	2 1/2	2900	117/8	47/8	S310VY08409
	8	3	3000	117/8	47/8	S310VY08509
	10	3	3000	14	47/8	S310VY10509

*Roller (01) bearings available. To order change "09" to "01". Example: S310VY10401.

Thick Tread Vulkollan on Cast Iron (09 Tapered Roller Bearing)*

Model	Wheel Diameter (inches)	Tread Width (inches)	Capacity (lbs)	Overall Height (inches)	Swivel Lead (inches)	Base Caster Number+
VX	6	3	3000	107/8	47/8	S310VX06509
	8	3	3000	117/8	47/8	S310VX08509
	10	3	3000	14	47/8	S310VX10509

*Roller (01) bearings available. To order change "09" to "01". Example: S310VX10501.

X-treme Plus Solid Polyurethane (28 Precision Ball Bearing)

Model	Wheel Diameter (inches)	Tread Width (inches)	Capacity (lbs)	Overall Height (inches)	Swivel Lead (inches)	Base Caster Number+
XP	8	2 1/2	2000	117/8	47/8	S310XP08428
	8	3	2000	117/8	47/8	S310XP08528
	10	2 1/2	2500	14	47/8	S310XP10428
	10	3	2500	14	47/8	S310XP10528

Phenolic (01 Roller Bearing)*

Model	Wheel Diameter (inches)	Tread Width (inches)	Capacity (lbs)	Overall Height (inches)	Swivel Lead (inches)	Base Caster Number+
TM	6	2 1/2	1600	107/8	47/8	S310TM06401
	6	3	2000	107/8	47/8	S310TM06501
	8	2 1/2	2000	117/8	47/8	S310TM08401
	8	3	2500	117/8	47/8	S310TM08501
	10	2 1/2	2500	14	47/8	S310TM10401
	10	3	2900	14	47/8	S310TM10501
	12	2 1/2	3000	16	5 11/16	S310TM12401
	12	3	3000	16	5 11/16	S310TM12501

*Tapered Roller (09) bearings available. To order change "01" to "09". Example: S310TM10409.

+ For swivel models add "S", for rigid model add "R" to end of base caster number.

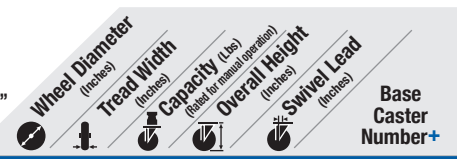

Trionix™ High Impact Polymer (28 Precision Ball Bearing)

Model	Wheel Diameter (inches)	Tread Width (inches)	Capacity (lbs)	Overall Height (inches)	Swivel Lead (inches)	Base Caster Number+
NX	6	2 1/2	3000	107/8	4-7/8	S310NX06428
	6	3	3000	107/8	4-7/8	S310NX06528
	8	2 1/2	3000	117/8	4-7/8	S310NX08428
	8	3	3000	117/8	4-7/8	S310NX08528
	10	2 1/2	3000	14	4-7/8	S310NX10428
	10	3	3000	14	4-7/8	S310NX10528

Cast Iron (01 Roller Bearing)*

Model	Wheel Diameter (inches)	Tread Width (inches)	Capacity (lbs)	Overall Height (inches)	Swivel Lead (inches)	Base Caster Number+
CA	6	2 1/2	2300	107/8	47/8	S310CA06401
	6	3	2800	107/8	47/8	S310CA06501
	8	2 1/2	2300	117/8	47/8	S310CA08401
	8	3	2800	117/8	47/8	S310CA08501
	10	2 1/2	2300	14	47/8	S310CA10401
	10	3	2800	14	47/8	S310CA10501
	12	3	2800	16	5 11/16	S310CA12501

*Tapered Roller (09) bearings available. To order change "01" to "09". Example: S310CA10409.

V-Groove Cast Iron (01 Roller Bearing)*

Model	Wheel Diameter (inches)	Tread Width (inches)	Capacity (lbs)	Overall Height (inches)	Swivel Lead (inches)	Base Caster Number+
VG/VF	6	2 1/2	2500	107/8	47/8	S310VG06401
	8	2 1/2	2500	117/8	47/8	S310VG08401
	8	3	2500	117/8	47/8	S310VG08501
	10	3	3000	14	47/8	S310VG10501

V-Groove Drop Forged Steel (01 Roller Bearing)

Model	Wheel Diameter (inches)	Tread Width (inches)	Capacity (lbs)	Overall Height (inches)	Swivel Lead (inches)	Base Caster Number+
8	3	3000	117/8	47/8	47/8	S310VF08501

*Tapered Roller (09) bearings available. To order change "01" to "09". Example: S310VF10409.

Drop Forged Steel (01 Roller Bearing)*

Model	Wheel Diameter (inches)	Tread Width (inches)	Capacity (lbs)	Overall Height (inches)	Swivel Lead (inches)	Base Caster Number+
FS	6	2 1/2	3000	107/8	47/8	S310FS06401
	8	2 1/2	3000	117/8	47/8	S310FS08401
	8	3	3000	117/8	47/8	S310FS08501
	10	3	3000	14	47/8	S310FS10501

*Tapered Roller (09) bearings available. To order change "01" to "09". Example: S310FS10509.

Ductile Iron Crowned Tread (01 Roller Bearing)*

Model	Wheel Diameter (inches)	Tread Width (inches)	Capacity (lbs)	Overall Height (inches)	Swivel Lead (inches)	Base Caster Number+
FR	6	2 1/2	3000	107/8	47/8	S310FR06401
	6	3	3000	107/8	47/8	S310FR06501
	8	3	3000	117/8	47/8	S310FR08501
	10	3	3000	14	47/8	S310FR10501

*Tapered Roller (09) bearings available. To order change "01" to "09". Example: S310FR08509.

Ductile Iron Flat Tread (01 Roller Bearing)*

Model	Wheel Diameter (inches)	Tread Width (inches)	Capacity (lbs)	Overall Height (inches)	Swivel Lead (inches)	Base Caster Number+
FM	6	2 1/2	3000	107/8	47/8	S310FM06401
	6	3	3000	107/8	47/8	S310FM06501
	8	3	3000	117/8	47/8	S310FM08501
	10	3	3000	14	47/8	S310FM10501

*Tapered Roller (09) bearings available. To order change "01" to "09". Example: S310FM08509.

Ductile Iron V-Groove Tread (01 Roller Bearing)*

Model	Wheel Diameter (inches)	Tread Width (inches)	Capacity (lbs)	Overall Height (inches)	Swivel Lead (inches)	Base Caster Number+
VM	6	2 1/2	3000	107/8	47/8	S310VM06401
	6	3	3000	107/8	47/8	S310VM06501
	8	3	3000	117/8	47/8	S310VM08501
	10	3	3000	14	47/8	S310VM10501

*Tapered Roller (09) bearings available. To order change "01" to "09". Example: S310VM08509.

S410

Contender Spring Loaded Kingpinless Casters

CAPACITY TO 3000

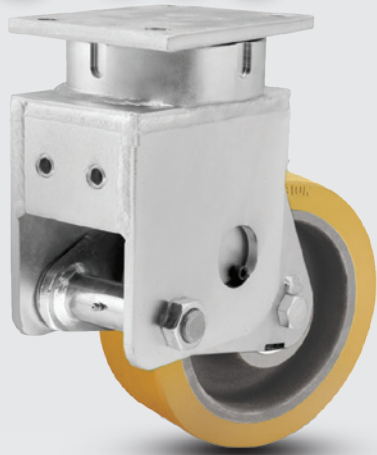

Designed from high quality, heat treated AISI 1045 stamped steel. Zinc plating delivers greater corrosion resistance than paint. Inside and outside welds deliver superior strength.

Greater capacity and better shock protection. Noise levels are reduced through the dampening effect of these casters.

Capacities listed at 50% of wheel deflection (21/32"). Total wheel deflection is 1-5/16".

TYPICAL APPLICATIONS

- Conveyor-drawn tow-trucks
- Heavy duty bakery racks
- Production dollies
- Heavy duty dough troughs
- Aviation Ground Support
- Aircraft Tripod Jacks
- Shock Sensitive Loads

SWIVEL CROSS SECTION

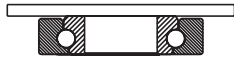

MOUNTING OPTIONS

Standard Plate

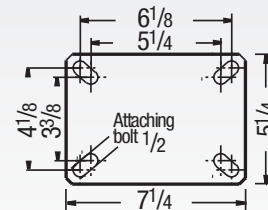

Special Order Plates

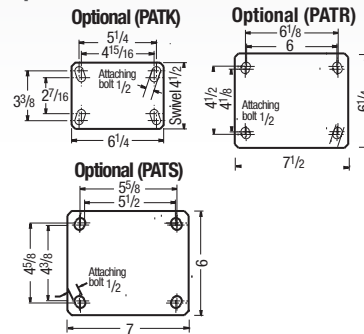

Premium Quality



Environmentally Friendly



Towing[^]

FEATURES

- **Load Springs:** Protect from damaging shocks and reduce noise levels through the dampening effect of the springs
- **Top Plate:** 3/8" AISI 1045 heat treated steel welded inside and out for longer life
- **Swivel Section:** One row of 1/2" ball bearings mounted in a heat treated precision machined raceway. ZerK in swivel section.
- **Yoke Base:** Notched AISI 1045 heat treated steel
- **Legs:** welded inside and out
- **Axle:** 3/4" diameter
- **Finish:** Zinc plating
- Alternate or custom caster configurations available

RIG OPTIONS

- For non-spring loaded versions, see 410 Series on pages 50-51
- S410 optional plates also available; consult factory

BRAKE OPTIONS

Consult factory

+ For swivel models add "S", for rigid model add "R" to end of base caster number.

Wheel Diameter (Inches)	Tread Width (Inches)	Capacity (Lbs) (Rate for manual operation)	Overall Height (Inches)	Swivel Lead (Inches)	Base Caster Number+
-------------------------	----------------------	--	-------------------------	----------------------	---------------------

Mold-on Polyurethane on Aluminum (01 Roller Bearing)*

PD	8	2 1/2	2010	117/8	47/8	S410PD08401
	8	3	2520	117/8	47/8	S410PD08501
	10	2 1/2	2370	14	47/8	S410PD10401
	10	3	3000	14	47/8	S410PD10501

Standard durometer 60 Shore D. Other durometers available.

*Tapered Roller (09) bearings available. To order change "01" to "09". Example: S410PD10409.

Polyurethane on Cast Iron (09 Tapered Roller Bearing)*

PY	6	2 1/2	1600	107/8	47/8	S410PY06409
	6 <td>3 <td>2000 <td>107/8 <td>47/8 <td>S410PY06509 </td></td></td></td></td>	3 <td>2000 <td>107/8 <td>47/8 <td>S410PY06509 </td></td></td></td>	2000 <td>107/8 <td>47/8 <td>S410PY06509 </td></td></td>	107/8 <td>47/8 <td>S410PY06509 </td></td>	47/8 <td>S410PY06509 </td>	S410PY06509
	8 <td>2 1/2 <td>2000 <td>117/8 <td>47/8 <td>S410PY08409 </td></td></td></td></td>	2 1/2 <td>2000 <td>117/8 <td>47/8 <td>S410PY08409 </td></td></td></td>	2000 <td>117/8 <td>47/8 <td>S410PY08409 </td></td></td>	117/8 <td>47/8 <td>S410PY08409 </td></td>	47/8 <td>S410PY08409 </td>	S410PY08409
	8 <td>3 <td>2500 <td>117/8 <td>47/8 <td>S410PY08509 </td></td></td></td></td>	3 <td>2500 <td>117/8 <td>47/8 <td>S410PY08509 </td></td></td></td>	2500 <td>117/8 <td>47/8 <td>S410PY08509 </td></td></td>	117/8 <td>47/8 <td>S410PY08509 </td></td>	47/8 <td>S410PY08509 </td>	S410PY08509
	10 <td>2 1/2 <td>2300 <td>14</td> <td>47/8 <td>S410PY10409 </td></td></td></td>	2 1/2 <td>2300 <td>14</td> <td>47/8 <td>S410PY10409 </td></td></td>	2300 <td>14</td> <td>47/8 <td>S410PY10409 </td></td>	14	47/8 <td>S410PY10409 </td>	S410PY10409
	10 <td>3 <td>3000 <td>14</td> <td>47/8 <td>S410PY10509 </td></td></td></td>	3 <td>3000 <td>14</td> <td>47/8 <td>S410PY10509 </td></td></td>	3000 <td>14</td> <td>47/8 <td>S410PY10509 </td></td>	14	47/8 <td>S410PY10509 </td>	S410PY10509
	12 <td>2 1/2 <td>2700 <td>16</td> <td>5 11/16</td> <td>S410PY12409 </td></td></td>	2 1/2 <td>2700 <td>16</td> <td>5 11/16</td> <td>S410PY12409 </td></td>	2700 <td>16</td> <td>5 11/16</td> <td>S410PY12409 </td>	16	5 11/16	S410PY12409
	12 <td>3 <td>3000 <td>16</td> <td>5 11/16</td> <td>S410PY12509 </td></td></td>	3 <td>3000 <td>16</td> <td>5 11/16</td> <td>S410PY12509 </td></td>	3000 <td>16</td> <td>5 11/16</td> <td>S410PY12509 </td>	16	5 11/16	S410PY12509

*Roller (01) bearings available. To order change "09" to "01".

Example: S410PY10401.

PY 80A

80 Shore A



80A Durometer available, add "80A" to end of caster number.

80A capacity reduced by approximately 20%.

Swivel example: S410PY06409S80A.

For 70D consult factory.

Thick Tread Polyurethane (09 Tapered Roller Bearing)*

PX	6	3	2250	107/8	47/8	S410PX06509
	8 <td>3 <td>2780 <td>117/8 <td>47/8 <td>S410PX08509 </td></td></td></td></td>	3 <td>2780 <td>117/8 <td>47/8 <td>S410PX08509 </td></td></td></td>	2780 <td>117/8 <td>47/8 <td>S410PX08509 </td></td></td>	117/8 <td>47/8 <td>S410PX08509 </td></td>	47/8 <td>S410PX08509 </td>	S410PX08509
	10 <td>2 1/2 <td>2600 <td>14</td> <td>47/8 <td>S410PX10409 </td></td></td></td>	2 1/2 <td>2600 <td>14</td> <td>47/8 <td>S410PX10409 </td></td></td>	2600 <td>14</td> <td>47/8 <td>S410PX10409 </td></td>	14	47/8 <td>S410PX10409 </td>	S410PX10409
	10 <td>3 <td>3000 <td>14</td> <td>47/8 <td>S410PX10509 </td></td></td></td>	3 <td>3000 <td>14</td> <td>47/8 <td>S410PX10509 </td></td></td>	3000 <td>14</td> <td>47/8 <td>S410PX10509 </td></td>	14	47/8 <td>S410PX10509 </td>	S410PX10509
	12 <td>3 <td>3000 <td>16</td> <td>5 11/16</td> <td>S410PX12509 </td></td></td>	3 <td>3000 <td>16</td> <td>5 11/16</td> <td>S410PX12509 </td></td>	3000 <td>16</td> <td>5 11/16</td> <td>S410PX12509 </td>	16	5 11/16	S410PX12509

Standard durometer 95 Shore A. Other durometers available.

*Roller (01) bearings available. To order change "09" to "01".

Example: S410PX10401.

Moldon Rubber on Cast Iron (09 Tapered Roller Bearing)*

MR/MH	6	2 1/2	700	107/8	47/8	S410MR06409
	6 <td>3 <td>750 <td>107/8 <td>47/8 <td>S410MR06509 </td></td></td></td></td>	3 <td>750 <td>107/8 <td>47/8 <td>S410MR06509 </td></td></td></td>	750 <td>107/8 <td>47/8 <td>S410MR06509 </td></td></td>	107/8 <td>47/8 <td>S410MR06509 </td></td>	47/8 <td>S410MR06509 </td>	S410MR06509
	8 <td>2 1/2 <td>850 <td>117/8 <td>47/8 <td>S410MR08409 </td></td></td></td></td>	2 1/2 <td>850 <td>117/8 <td>47/8 <td>S410MR08409 </td></td></td></td>	850 <td>117/8 <td>47/8 <td>S410MR08409 </td></td></td>	117/8 <td>47/8 <td>S410MR08409 </td></td>	47/8 <td>S410MR08409 </td>	S410MR08409
	8 <td>3 <td>900 <td>117/8 <td>47/8 <td>S410MR08509 </td></td></td></td></td>	3 <td>900 <td>117/8 <td>47/8 <td>S410MR08509 </td></td></td></td>	900 <td>117/8 <td>47/8 <td>S410MR08509 </td></td></td>	117/8 <td>47/8 <td>S410MR08509 </td></td>	47/8 <td>S410MR08509 </td>	S410MR08509
	10 <td>2 1/2 <td>950 <td>14</td> <td>47/8 <td>S410MR10409 </td></td></td></td>	2 1/2 <td>950 <td>14</td> <td>47/8 <td>S410MR10409 </td></td></td>	950 <td>14</td> <td>47/8 <td>S410MR10409 </td></td>	14	47/8 <td>S410MR10409 </td>	S410MR10409
	10 <td>2 1/2** <td>1500 <td>14</td> <td>47/8 <td>S410MH10409 </td></td></td></td>	2 1/2** <td>1500 <td>14</td> <td>47/8 <td>S410MH10409 </td></td></td>	1500 <td>14</td> <td>47/8 <td>S410MH10409 </td></td>	14	47/8 <td>S410MH10409 </td>	S410MH10409
	10 <td>3 <td>1000 <td>14</td> <td>47/8 <td>S410MR10509 </td></td></td></td>	3 <td>1000 <td>14</td> <td>47/8 <td>S410MR10509 </td></td></td>	1000 <td>14</td> <td>47/8 <td>S410MR10509 </td></td>	14	47/8 <td>S410MR10509 </td>	S410MR10509
	10 <td>3** <td>1800 <td>14</td> <td>47/8 <td>S410MH10509 </td></td></td></td>	3** <td>1800 <td>14</td> <td>47/8 <td>S410MH10509 </td></td></td>	1800 <td>14</td> <td>47/8 <td>S410MH10509 </td></td>	14	47/8 <td>S410MH10509 </td>	S410MH10509
	12 <td>2 1/2 <td>950 <td>16</td> <td>5 11/16 <td>S410MR12409 </td></td></td></td>	2 1/2 <td>950 <td>16</td> <td>5 11/16 <td>S410MR12409 </td></td></td>	950 <td>16</td> <td>5 11/16 <td>S410MR12409 </td></td>	16	5 11/16 <td>S410MR12409 </td>	S410MR12409
	12 <td>2 1/2** <td>1700 <td>16</td> <td>5 11/16 <td>S410MH12409 </td></td></td></td>	2 1/2** <td>1700 <td>16</td> <td>5 11/16 <td>S410MH12409 </td></td></td>	1700 <td>16</td> <td>5 11/16 <td>S410MH12409 </td></td>	16	5 11/16 <td>S410MH12409 </td>	S410MH12409
	12 <td>3 <td>1200 <td>16</td> <td>5 11/16 <td>S410MR12509 </td></td></td></td>	3 <td>1200 <td>16</td> <td>5 11/16 <td>S410MR12509 </td></td></td>	1200 <td>16</td> <td>5 11/16 <td>S410MR12509 </td></td>	16	5 11/16 <td>S410MR12509 </td>	S410MR12509

*Roller (01) bearings available. To order change "09" to "01".

Example: S410MR10401.

**Heavy-duty MH version of wheel.

Continue on next page >>

+ For swivel models add "S", for rigid model add "R" to end of base caster number.

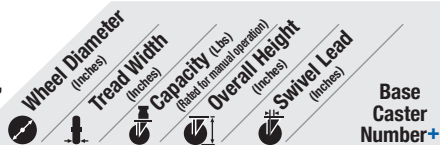

Aubin Industries Swivel-EAZ® Crown Tread (28 Prec. Ball Bearing)

EY	Wheel Diameter (inches)	Tread Width (inches)	Capacity (lbs) (rated for manual operation)	Overall Height (inches)	Swivel Lead (inches)	Base Caster Number+
EY	6	3	2137	10 ⁷ / ₈	4 ⁷ / ₈	S410EY06528
	8	3	3000	11 ⁷ / ₈	4 ⁷ / ₈	S410EY08528

Standard durometer 95 Shore A. Other durometers available.



Aubin Industries Swivel-EAZ® Flat Tread (28 Prec. Ball Bearing)

EZ	Wheel Diameter (inches)	Tread Width (inches)	Capacity (lbs) (rated for manual operation)	Overall Height (inches)	Swivel Lead (inches)	Base Caster Number+
EZ	6	3	2850	10 ⁷ / ₈	4 ⁷ / ₈	S410EZ06528
	8	3	3000	11 ⁷ / ₈	4 ⁷ / ₈	S410EZ08528
	10	3	3000	14	4 ⁷ / ₈	S410EZ10528

Standard durometer 95 Shore A. Other durometers available.



Polyurethane on Heavy Duty Cast Iron (28 Precision Ball Bearing)*

PF	Wheel Diameter (inches)	Tread Width (inches)	Capacity (lbs) (rated for manual operation)	Overall Height (inches)	Swivel Lead (inches)	Base Caster Number+
PF	6	2 ¹ / ₂	2900	10 ⁷ / ₈	4 ⁷ / ₈	S410PF06428
	8	2 ¹ / ₂	3000	11 ⁷ / ₈	4 ⁷ / ₈	S410PF08428
	8	3	3000	11 ⁷ / ₈	4 ⁷ / ₈	S410PF08528
	10	3	3000	14	4 ⁷ / ₈	S410PF10528

95 Shore A



*Tapered Roller (09) bearings available. To order change "28" to "09". Example: S410PF10509.

Polyurethane Reactive on Iron (28 Precision Ball Bearing)*

PR	Wheel Diameter (inches)	Tread Width (inches)	Capacity (lbs) (rated for manual operation)	Overall Height (inches)	Swivel Lead (inches)	Base Caster Number+
PR	10	3	2400	14	4 ⁷ / ₈	S410PR10528
	12	3	2800	16	5 ¹¹ / ₁₆	S410PR12528

80 Shore A



*Tapered Roller (09) bearings available. To order change "28" to "09". Example: S410PR10509.

Vulkollan on Cast Iron (09 Tapered Roller Bearing)*

VY	Wheel Diameter (inches)	Tread Width (inches)	Capacity (lbs) (rated for manual operation)	Overall Height (inches)	Swivel Lead (inches)	Base Caster Number+
VY	6	2 ¹ / ₂	2350	10 ⁷ / ₈	4 ⁷ / ₈	S410VY06409
	8	2 ¹ / ₂	2900	11 ⁷ / ₈	4 ⁷ / ₈	S410VY08409
	8	3	3000	11 ⁷ / ₈	4 ⁷ / ₈	S410VY08509
	10	3	3000	14	4 ⁷ / ₈	S410VY10509



*Roller (01) bearings available. To order change "09" to "01". Example: S410VY10501.

Thick Tread Vulkollan on Cast Iron (09 Tapered Roller Bearing)*

VX	Wheel Diameter (inches)	Tread Width (inches)	Capacity (lbs) (rated for manual operation)	Overall Height (inches)	Swivel Lead (inches)	Base Caster Number+
VX	6	3	3000	10 ⁷ / ₈	4 ⁷ / ₈	S410VX06509
	8	3	3000	11 ⁷ / ₈	4 ⁷ / ₈	S410VX08509
	10	3	3000	14	4 ⁷ / ₈	S410VX10509



*Roller (01) bearings available. To order change "09" to "01". Example: S410VX10501.

X-treme Plus Solid Polyurethane (28 Precision Ball Bearing)

XP	Wheel Diameter (inches)	Tread Width (inches)	Capacity (lbs) (rated for manual operation)	Overall Height (inches)	Swivel Lead (inches)	Base Caster Number+
XP	8	2 ¹ / ₂	2000	11 ⁷ / ₈	4 ⁷ / ₈	S410XP08428
	8	3	2000	11 ⁷ / ₈	4 ⁷ / ₈	S410XP08528
	10	2 ¹ / ₂	2500	14	4 ⁷ / ₈	S410XP10428
	10	3	2500	14	4 ⁷ / ₈	S410XP10528



Phenolic (01 Roller Bearing)*

TM	Wheel Diameter (inches)	Tread Width (inches)	Capacity (lbs) (rated for manual operation)	Overall Height (inches)	Swivel Lead (inches)	Base Caster Number+
TM	6	2 ¹ / ₂	1600	10 ⁷ / ₈	4 ⁷ / ₈	S410TM06401
	6	3	2000	10 ⁷ / ₈	4 ⁷ / ₈	S410TM06501
	8	2 ¹ / ₂	2000	11 ⁷ / ₈	4 ⁷ / ₈	S410TM08401
	8	3	2500	11 ⁷ / ₈	4 ⁷ / ₈	S410TM08501
	10	2 ¹ / ₂	2500	14	4 ⁷ / ₈	S410TM10401
	10	3	2900	14	4 ⁷ / ₈	S410TM10501
	12	2 ¹ / ₂	3000	16	5 ¹¹ / ₁₆	S410TM12401
	12	3	3000	16	5 ¹¹ / ₁₆	S410TM12501



*Tapered Roller (09) bearings available. To order change "01" to "09". Example: S410TM10409.

+ For swivel models add "S", for rigid model add "R" to end of base caster number.

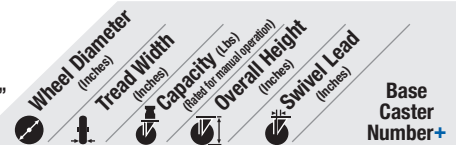

Trionix™ High Impact Polymer (28 Precision Ball Bearing)

NX	Wheel Diameter (inches)	Tread Width (inches)	Capacity (lbs) (rated for manual operation)	Overall Height (inches)	Swivel Lead (inches)	Base Caster Number+
NX	6	2 ¹ / ₂	3000	10 ⁷ / ₈	4 ⁷ / ₈	S410NX06428
	6	3	3000	10 ⁷ / ₈	4 ⁷ / ₈	S410NX06528
	8	2 ¹ / ₂	3000	11 ⁷ / ₈	4 ⁷ / ₈	S410NX08428
	8	3	3000	11 ⁷ / ₈	4 ⁷ / ₈	S410NX08528
	10	2 ¹ / ₂	3000	14	4 ⁷ / ₈	S410NX10428
	10	3	3000	14	4 ⁷ / ₈	S410NX10528



Cast Iron (01 Roller Bearing)*

CA	Wheel Diameter (inches)	Tread Width (inches)	Capacity (lbs) (rated for manual operation)	Overall Height (inches)	Swivel Lead (inches)	Base Caster Number+
CA	6	2 ¹ / ₂	2300	10 ⁷ / ₈	4 ⁷ / ₈	S410CA06401
	6	3	2800	10 ⁷ / ₈	4 ⁷ / ₈	S410CA06501
	8	2 ¹ / ₂	2300	11 ⁷ / ₈	4 ⁷ / ₈	S410CA08401
	8	3	2800	11 ⁷ / ₈	4 ⁷ / ₈	S410CA08501
	10	2 ¹ / ₂	2300	14	4 ⁷ / ₈	S410CA10401
	10	3	2800	14	4 ⁷ / ₈	S410CA10501
	12	3	2800	16	5 ¹¹ / ₁₆	S410CA12501



*Tapered Roller (09) bearings available. To order change "01" to "09". Example: S410CA10409.

V-Groove Cast Iron (01 Roller Bearing)*

VG/VF	Wheel Diameter (inches)	Tread Width (inches)	Capacity (lbs) (rated for manual operation)	Overall Height (inches)	Swivel Lead (inches)	Base Caster Number+
VG/VF	6	2 ¹ / ₂	2500	10 ⁷ / ₈	4 ⁷ / ₈	S410VG06401
	8	2 ¹ / ₂	2500	11 ⁷ / ₈	4 ⁷ / ₈	S410VG08401
	8	3	2500	11 ⁷ / ₈	4 ⁷ / ₈	S410VG08501
	10	3	3000	14	4 ⁷ / ₈	S410VG10501



V-Groove Drop Forged Steel (01 Roller Bearing)

	Wheel Diameter (inches)	Tread Width (inches)	Capacity (lbs) (rated for manual operation)	Overall Height (inches)	Swivel Lead (inches)	Base Caster Number+
	8	3	3000	11 ⁷ / ₈	4 ⁷ / ₈	S410VF08501

*Tapered Roller (09) bearings available. To order change "01" to "09". Example: S410VG10409.

Drop Forged Steel (01 Roller Bearing)*

FS	Wheel Diameter (inches)	Tread Width (inches)	Capacity (lbs) (rated for manual operation)	Overall Height (inches)	Swivel Lead (inches)	Base Caster Number+
FS	6	2 ¹ / ₂	3000	10 ⁷ / ₈	4 ⁷ / ₈	S410FS06401
	8	2 ¹ / ₂	3000	11 ⁷ / ₈	4 ⁷ / ₈	S410FS08401
	8	3	3000	11 ⁷ / ₈	4 ⁷ / ₈	S410FS08501
	10	3	3000	14	4 ⁷ / ₈	S410FS10501



*Tapered Roller (09) bearings available. To order change "01" to "09". Example: S410FS10509.

Ductile Iron Crowned Tread (01 Roller Bearing)*

FR	Wheel Diameter (inches)	Tread Width (inches)	Capacity (lbs) (rated for manual operation)	Overall Height (inches)	Swivel Lead (inches)	Base Caster Number+
FR	6	2 ¹ / ₂	3000	10 ⁷ / ₈	4 ⁷ / ₈	S410FR06401
	6	3	3000	10 ⁷ / ₈	4 ⁷ / ₈	S410FR06501
	8	3	3000	11 ⁷ / ₈	4 ⁷ / ₈	S410FR08501
	10	3	3000	14	4 ⁷ / ₈	S410FR10501



*Tapered Roller (09) bearings available. To order change "01" to "09". Example: S410FR08509.

Ductile Iron Flat Tread (01 Roller Bearing)*

FM	Wheel Diameter (inches)	Tread Width (inches)	Capacity (lbs) (rated for manual operation)	Overall Height (inches)	Swivel Lead (inches)	Base Caster Number+
FM	6	2 ¹ / ₂	3000	10 ⁷ / ₈	4 ⁷ / ₈	S410FM06401
	6	3	3000	10 ⁷ / ₈	4 ⁷ / ₈	S410FM06501
	8	3	3000	11 ⁷ / ₈	4 ⁷ / ₈	S410FM08501
	10	3	3000	14	4 ⁷ / ₈	S410FM10501



*Tapered Roller (09) bearings available. To order change "01" to "09". Example: S410FM08509.

Ductile Iron V-Groove Tread (01 Roller Bearing)*

VM	Wheel Diameter (inches)	Tread Width (inches)	Capacity (lbs) (rated for manual operation)	Overall Height (inches)	Swivel Lead (inches)	Base Caster Number+
VM	6	2 ¹ / ₂	3000	10 ⁷ / ₈	4 ⁷ / ₈	S410VM06401
	6	3	3000	10 ⁷ / ₈	4 ⁷ / ₈	S410VM06501
	8	3	3000	11 ⁷ / ₈	4 ⁷ / ₈	S410VM08501
	10	3	3000	14	4 ⁷ / ₈	S410VM10501



*Tapered Roller (09) bearings available. To order change "01" to "09". Example: S410VM08509.

S610 Contender Spring Loaded Kingpinless Casters

CAPACITY TO 3000

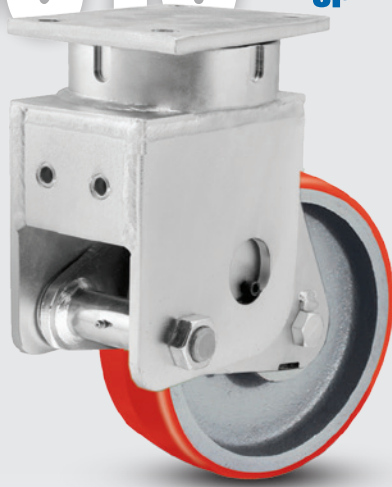

Highly recommended for automotive and aerospace applications. This caster is built to take the punishment of constant swiveling or for service where shock or impact loads might damage less rugged casters.

Greater capacity and better shock protection. Noise levels are reduced through the dampening effect of these casters.

Capacities listed at 50% of wheel deflection (21/32"). Total wheel deflection is 1-5/16".

MOUNTING OPTION

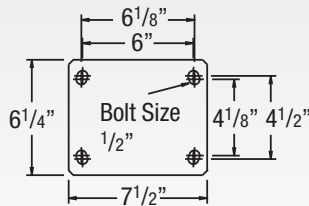

SWIVEL CROSS SECTION



TYPICAL APPLICATIONS

- Body dolly carts
- Engine dollies
- Material carts
- Chassis rack carts
- Paint line dollies
- Towed trash gondolas
- Aviation Ground Support
- Aircraft Tripod Jacks
- Shock Sensitive Loads

+ For swivel models add "S", for rigid model add "R" to end of base caster number.

Wheel Diameter (Inches)	Tread Width (Inches)	Capacity (Lbs) (Based on manual operation)	Overall Height (Inches)	Swivel Lead (Inches)	Base Caster Number+
-------------------------	----------------------	--	-------------------------	----------------------	---------------------

Moldon Rubber on Cast Iron (09 Tapered Roller Bearing)*

MR/MH	6	2 1/2	700	1 13/4	4 1/2	S610MR06409
	6	3	750	1 13/4	4 1/2	S610MR06509
	8	2 1/2	850	1 23/4	4 1/2	S610MR08409
	8	3	900	1 23/4	4 1/2	S610MR08509
	10	2 1/2	950	1 47/8	4 1/2	S610MR10409
	10	2 1/2**	1500	1 47/8	4 1/2	S610MH10409
	10	3	1000	1 47/8	4 1/2	S610MR10509
	10	3**	1800	1 47/8	4 1/2	S610MH10509
	12	2 1/2	950	1 67/8	5 5/16	S610MR12409
	12	2 1/2**	1700	1 67/8	5 5/16	S610MH12409
	12	3	1200	1 67/8	5 5/16	S610MR12509

*Roller (01) bearings available. To order change "09" to "01". Example: S610MR10401.

**Heavy-duty MH version of wheel.



Premium Quality



Environmentally Friendly



Towing^

FEATURES

- **Load Springs:** Protect from damaging shocks and reduce noise levels through the dampening effect of the springs
- **Top Plate:** 1/2" AISI 1045 heat treated steel welded inside and out for longer life
- **Swivel Section:** 3/4" ball bearings mounted in a 4-3/8" precision machined raceway. Zerk in swivel section
- **Yoke Base:** Notched AISI 1045 heat treated steel
- **Legs:** 3/8" thick steel welded to yoke base using 100,000 psi weld filler
- **Axle:** 2-1/2" and 3" tread width wheels feature a 3/4" axle, 3-1/2" and 4" tread width wheels feature a 1" axle
- Alternate or custom caster configurations available

RIG OPTIONS

- For non-spring loaded versions, see 610 Series on pages 52-53
- S410 optional plates also available; consult factory

BRAKE OPTIONS

Consult factory

+ For swivel models add "S", for rigid model add "R" to end of base caster number.

Wheel Diameter (Inches)	Tread Width (Inches)	Capacity (Lbs) (Based on manual operation)	Overall Height (Inches)	Swivel Lead (Inches)	Base Caster Number+
-------------------------	----------------------	--	-------------------------	----------------------	---------------------

Mold-on Polyurethane on Aluminum (01 Roller Bearing)*

PD	8	2 1/2	2010	1 23/4	4 1/2	S610PD08401
	8 <td>3 <td>2520 <th>1 23/4</th> <th>4 1/2</th> <th>S610PD08501</th> </td></td>	3 <td>2520 <th>1 23/4</th> <th>4 1/2</th> <th>S610PD08501</th> </td>	2520 <th>1 23/4</th> <th>4 1/2</th> <th>S610PD08501</th>	1 23/4	4 1/2	S610PD08501
	10 <th>2 1/2</th> <th>2370</th> <th>1 47/8</th> <th>4 1/2</th> <th>S610PD10401</th>	2 1/2	2370	1 47/8	4 1/2	S610PD10401
	10 <th>3</th> <th>2000</th> <th>1 47/8</th> <th>4 1/2</th> <th>S610PD10501</th>	3	2000	1 47/8	4 1/2	S610PD10501

Standard durometer 60 Shore D. Other durometers available.

*Tapered Roller (09) bearings available.

To order change "01" to "09". Example: S610PD10409.

Polyurethane on Cast Iron (09 Tapered Roller Bearing)*

PY	6	2 1/2	1600	1 13/4	4 1/2	S610PY06409
	6	3	2000	1 13/4	4 1/2	S610PY06509
	8 <th>2 1/2</th> <th>2000</th> <th>1 23/4</th> <th>4 1/2</th> <th>S610PY08409</th>	2 1/2	2000	1 23/4	4 1/2	S610PY08409
	8 <th>3</th> <th>2500</th> <th>1 23/4</th> <th>4 1/2</th> <th>S610PY08509</th>	3	2500	1 23/4	4 1/2	S610PY08509
	10 <th>2 1/2</th> <th>2300</th> <th>1 47/8</th> <th>4 1/2</th> <th>S610PY10409</th>	2 1/2	2300	1 47/8	4 1/2	S610PY10409
	10 <th>3</th> <th>3000</th> <th>1 47/8</th> <th>4 1/2</th> <th>S610PY10509</th>	3	3000	1 47/8	4 1/2	S610PY10509
95 Shore A	12 <th>2 1/2</th> <th>2700</th> <th>1 67/8</th> <th>5 5/16</th> <th>S610PY12409</th>	2 1/2	2700	1 67/8	5 5/16	S610PY12409
	12 <th>3</th> <th>3000</th> <th>1 67/8</th> <th>5 5/16</th> <th>S610PY12509</th>	3	3000	1 67/8	5 5/16	S610PY12509

*Roller (01) bearings available.

To order change "09" to "01". Example: S610PY10401. 80A Durometer available, add "80A" to end of caster number.

80A capacity reduced by approximately 20%.

Swivel example: S610PY06409S80A.

For 70D consult factory.

Thick Tread Polyurethane (09 Tapered Roller Bearing)*

PX	6	3	2250	1 13/4	4 1/2	S610PX06509
	8 <th>3</th> <th>2780</th> <th>1 23/4</th> <th>4 1/2</th> <th>S610PX08509</th>	3	2780	1 23/4	4 1/2	S610PX08509
	10 <th>2 1/2</th> <th>2600</th> <th>1 47/8</th> <th>4 1/2</th> <th>S610PX10409</th>	2 1/2	2600	1 47/8	4 1/2	S610PX10409
	10 <th>3</th> <th>3000</th> <th>1 47/8</th> <th>4 1/2</th> <th>S610PX10509</th>	3	3000	1 47/8	4 1/2	S610PX10509
	12 <th>3</th> <th>3000</th> <th>1 67/8</th> <th>5 5/16</th> <th>S610PX12509</th>	3	3000	1 67/8	5 5/16	S610PX12509

Standard durometer 95 Shore A. Other durometers available.

*Roller (01) bearings available. To order change "09" to "01".

Example: S610PX10401.

Continue on next page >>

+ For swivel models add "S", for rigid model add "R" to end of base caster number.



Aubin Industries Swivel-EAZ® Crown Tread (28 Prec. Ball Bearing)

EY	6	3	2137	11 ³ / ₄	4 ¹ / ₂	S610EY06528
	8	3	3000	12 ³ / ₄	4 ¹ / ₂	S610EY08528

Standard durometer 95 Shore A. Other durometers available.



Aubin Industries Swivel-EAZ® Flat Tread (28 Prec. Ball Bearing)

EZ	6	3	2850	11 ³ / ₄	4 ¹ / ₂	S610EZ06528
	8	3	3000	12 ³ / ₄	4 ¹ / ₂	S610EZ08528
	10	3	3000	14 ⁷ / ₈	4 ¹ / ₂	S610EZ10528

Standard durometer 95 Shore A. Other durometers available.



Polyurethane on Heavy Duty Cast Iron (28 Precision Ball Bearing)*

PF	6	2 ¹ / ₂	2900	11 ³ / ₄	4 ¹ / ₂	S610PF06428
	8	2 ¹ / ₂	3000	12 ³ / ₄	4 ¹ / ₂	S610PF08428
	8	3	3000	12 ³ / ₄	4 ¹ / ₂	S610PF08528
	10	3	3000	14 ⁷ / ₈	4 ¹ / ₂	S610PF10528

95 Shore A



*Tapered Roller (09) bearings available. To order change "28" to "09". Example: S610PF10509.

Polyurethane Reactive on Iron (28 Precision Ball Bearing)*

PR	10	3	2400	14 ⁷ / ₈	4 ¹ / ₂	S610PR10528
	12	3	2800	16 ⁷ / ₈	5 ⁵ / ₁₆	S610PR12528

80 Shore A



*Tapered Roller (09) bearings available. To order change "28" to "09". Example: S610PR10509.

Vulkollan on Cast Iron (09 Tapered Roller Bearing)*

VY	6	2 ¹ / ₂	2350	11 ³ / ₄	4 ¹ / ₂	S610VY06409
	8	2 ¹ / ₂	2900	12 ³ / ₄	4 ¹ / ₂	S610VY08409
	8	3	3000	12 ³ / ₄	4 ¹ / ₂	S610VY08509
	10	3	3000	14 ⁷ / ₈	4 ¹ / ₂	S610VY10509



*Roller (01) bearings available. To order change "09" to "01". Example: S610VY10501.

Thick Tread Vulkollan on Cast Iron (09 Tapered Roller Bearing)*

VX	6	3	3000	11 ³ / ₄	4 ¹ / ₂	S610VX06509
	8	3	3000	12 ³ / ₄	4 ¹ / ₂	S610VX08509
	10	3	3000	14 ⁷ / ₈	4 ¹ / ₂	S610VX10509



*Roller (01) bearings available. To order change "09" to "01". Example: S610VX10501.

X-treme Plus Solid Polyurethane (28 Precision Ball Bearing)

XP	8	2 ¹ / ₂	2000	12 ³ / ₄	4 ¹ / ₂	S610XP08428
	8	3	2000	12 ³ / ₄	4 ¹ / ₂	S610XP08528
	10	2 ¹ / ₂	2500	14 ⁷ / ₈	4 ¹ / ₂	S610XP10428
	10	3	2500	14 ⁷ / ₈	4 ¹ / ₂	S610XP10528



Phenolic (01 Roller Bearing)*

TM	6	2 ¹ / ₂	1600	11 ³ / ₄	4 ¹ / ₂	S610TM06401
	6	3	2000	11 ³ / ₄	4 ¹ / ₂	S610TM06501
	8	2 ¹ / ₂	2000	12 ³ / ₄	4 ¹ / ₂	S610TM08401
	8	3	2500	12 ³ / ₄	4 ¹ / ₂	S610TM08501
	10	2 ¹ / ₂	2500	14 ⁷ / ₈	4 ¹ / ₂	S610TM10401
	10	3	2900	14 ⁷ / ₈	4 ¹ / ₂	S610TM10501
	12	2 ¹ / ₂	3000	16 ⁷ / ₈	5 ⁵ / ₁₆	S610TM12401
	12	3	3000	16 ⁷ / ₈	5 ⁵ / ₁₆	S610TM12501



*Tapered Roller (09) bearings available. To order change "01" to "09". Example: S610TM10409.

+ For swivel models add "S", for rigid model add "R" to end of base caster number.



Trionix™ High Impact Polymer (28 Precision Ball Bearing)

NX	6	2 ¹ / ₂	3000	11 ³ / ₄	4 ¹ / ₂	S610NX06428
	6	3	3000	11 ³ / ₄	4 ¹ / ₂	S610NX06528
	8	2 ¹ / ₂	3000	12 ³ / ₄	4 ¹ / ₂	S610NX08428
	8	3	3000	12 ³ / ₄	4 ¹ / ₂	S610NX08528
	10	2 ¹ / ₂	3000	14 ⁷ / ₈	4 ¹ / ₂	S610NX10428
	10	3	3000	14 ⁷ / ₈	4 ¹ / ₂	S610NX10528



Cast Iron (01 Roller Bearing)*

CA	6	2 ¹ / ₂	2300	11 ³ / ₄	4 ¹ / ₂	S610CA06401
	6	3	2800	11 ³ / ₄	4 ¹ / ₂	S610CA06501
	8	2 ¹ / ₂	2300	12 ³ / ₄	4 ¹ / ₂	S610CA08401
	8	3	2800	12 ³ / ₄	4 ¹ / ₂	S610CA08501
	10	2 ¹ / ₂	2300	14 ⁷ / ₈	4 ¹ / ₂	S610CA10401
	10	3	2800	14 ⁷ / ₈	4 ¹ / ₂	S610CA10501
	12	3	2800	16 ⁷ / ₈	5 ⁵ / ₁₆	S610CA12501



*Tapered Roller (09) bearings available. To order change "01" to "09". Example: S610CA10409.

V-Groove Cast Iron (01 Roller Bearing)*

VG/VF	6	2 ¹ / ₂	2500	11 ³ / ₄	4 ¹ / ₂	S610VG06401
	8	2 ¹ / ₂	2500	12 ³ / ₄	4 ¹ / ₂	S610VG08401
	8	3	2500	12 ³ / ₄	4 ¹ / ₂	S610VG08501
	10	3	3000	14 ⁷ / ₈	4 ¹ / ₂	S610VG10501



V-Groove Drop Forged Steel (01 Roller Bearing)

8	3	3000	12 ³ / ₄	4 ¹ / ₂	S610VF08501
---	---	------	--------------------------------	-------------------------------	-------------

*Tapered Roller (09) bearings available. To order change "01" to "09". Example: S610VG10509.

Drop Forged Steel (01 Roller Bearing)*

FS	6	2 ¹ / ₂	3000	11 ³ / ₄	4 ¹ / ₂	S610FS06401
	8	2 ¹ / ₂	3000	12 ³ / ₄	4 ¹ / ₂	S610FS08401
	8	3	3000	12 ³ / ₄	4 ¹ / ₂	S610FS08501
	10	3	3000	14 ⁷ / ₈	4 ¹ / ₂	S610FS10501



*Tapered Roller (09) bearings available. To order change "01" to "09". Example: S610FS10509.

Ductile Iron Crowned Tread (01 Roller Bearing)*

FR	6	2 ¹ / ₂	3000	11 ³ / ₄	4 ¹ / ₂	S610FR06401
	6	3	3000	11 ³ / ₄	4 ¹ / ₂	S610FR06501
	8	3	3000	11 ⁷ / ₈	4 ¹ / ₂	S610FR08501
	10	3	3000	14 ⁷ / ₈	4 ¹ / ₂	S610FR10501



*Tapered Roller (09) bearings available. To order change "01" to "09". Example: S610FR08509.

Ductile Iron Flat Tread (01 Roller Bearing)*

FM	6	2 ¹ / ₂	3000	11 ³ / ₄	4 ¹ / ₂	S610FM06401
	6	3	3000	11 ³ / ₄	4 ¹ / ₂	S610FM06501
	8	3	3000	11 ⁷ / ₈	4 ¹ / ₂	S610FM08501
	10	3	3000	14 ⁷ / ₈	4 ¹ / ₂	S610FM10501



*Tapered Roller (09) bearings available. To order change "01" to "09". Example: S610FM08509.

Ductile Iron V-Groove Tread (01 Roller Bearing)*

VM	6	2 ¹ / ₂	3000	11 ³ / ₄	4 ¹ / ₂	S610VM06401
	6	3	3000	11 ³ / ₄	4 ¹ / ₂	S610VM06501
	8	3	3000	11 ⁷ / ₈	4 ¹ / ₂	S610VM08501
	10	3	3000	14 ⁷ / ₈	4 ¹ / ₂	S610VM10501



*Tapered Roller (09) bearings available. To order change "01" to "09". Example: S610VM08509.

DUAL WHEEL CASTERS

CAPACITY RANGE 280-30000 LBS



850 Series

When Failure is Not an Option.

Common Applications:

- Tool Carts
- Group Support Equipment
- Storage Racks
- Low Profile Carts
- Platforms
- Custom Material Handling
- Towable Transportation Equipment
- Workstations/Packaging

Cantilever Style



216 Series
Capacity to 900 101



263 Series
Capacity to 2000 102



281 Series
Capacity to 2000 103



290/295 Series
Capacity to 8000 104

Kingpinless Style



115 Series
Capacity to 2000 105



315 Series
Capacity to 4100 106



415/615 Series
Capacity to 12000 107



850 Series
Capacity to 30000 108

Standard Kingpin Style



272/281 Series
Capacity up to 12000..... 109



290-293 Series
Capacity up to 7500..... 110



295 Series
Capacity up to 17000..... 111

Aviation Ground Equipment Style



298 Series
Capacity up to 20000..... 112

What are the Advantages of Albion's Dual Wheels?

- Higher load ratings with low overall heights
- Better product stability for safer footprint
- Maintain higher load ratings with softer wheel options – providing added floor and equipment protection

216

Cantilever-Style Dual Wheel Casters

CAPACITY TO 900



In most instances, these casters offer greater capacity, while maintaining the lowest possible overall height. Differential action helps to reduce scrubbing when changing directions. Because they are made from the single wheel caster rig, cantilever-style dual wheel casters can be field built.

MOUNTING OPTION

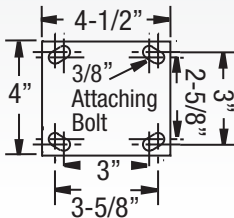

CANTILEVER KITS

Kit Number*	For Series	Axle Part Number Only
CK216000	16, 62, 71 and 72	ZJ08120004

Transform your standard 16, 62, 71 or 72 Series rig into a Dual Wheel caster with this field installable Cantilever Kit. *Kit includes the axle, nut, and spacers required to mount two wheels on a standard rig.

Field installable kits also available! See cantilever kits above.



Premium Quality



Environmentally Friendly

FEATURES

- **Improved zinc plated finish** for attractive appearance, better corrosion resistance and longer caster life
- **Bigger kingpin:** New bigger, stronger 3/4" kingpin on standard top plate
- **Top Plate & Yoke Base:** Cold formed from 1/4" steel plate. Yoke base is notched for factory or field-installable 4-position swivel lock
- **Swivel Section:** Smooth formed, hardened double ball bearing raceways minimize ball indentation and wear
- **Fork Legs:** 1/4" steel, formed to increase strength and welded to yoke base
- **Axle:** 1/2" diameter hollow axle complete with lock nut with straight roller and Delrin bearings. Axle is solid with ball, plain bore, and Oilex bearings
- **Lubrication:** Zerk fitting in swivel section and in recessed head of hollow axle on straight roller and Delrin bearing wheels
- See 16 Series section for additional features
- Alternate or custom caster configurations available
- Note: 216 Series is a dual wheel 16 Series

BEARING OPTIONS



Straight Roller (01)



Pedestal Precision (29)

RIG OPTIONS

- **Swivel Lock** (welded) specify **L**
- **Foot operated field installable** swivel lock specify **SL160002**

+ For swivel models add "SK", for rigid model add "RK" to end of base caster number.

Wheel Diameter (Inches)		Tread Width (Inches)	Capacity (Lbs) (Based on minimal separation)	Overall Height (Inches)	Swivel Lead (Inches)	Swivel Radius (Inches)	Approx. Wt. (Lbs)	Wheel Type	Base Caster Number+ Roller Bearing (01)
216 Cantilever-Style Dual Wheel									
3 1/4	1 1/2	680	4 1/4	13/4	45/8	53/4		Mold-on Rubber/Iron	216MH03101
3 1/4	1 1/2	840	4 1/4	13/4	45/8	5 1/2		Polyurethane/Iron	216PY03101
3 1/4	1 1/2	900	4 1/4	13/4	45/8	5 1/4		Phenolic	216TM03101
4	1 1/2	340	5 5/8	13/4	47/8	6 1/2		Soft Rubber	216RR04101
4	1 1/2	500	5 5/8	13/4	47/8	8		Mold-on Rubber/Iron	216MR04101
4	1 1/2	500	5 5/8	13/4	47/8	6		Mold-on Rubber/Alu.	216MD04101
4	1 1/2	800	5 5/8	13/4	47/8	5 1/2		Polypropylene	216PB04101
4	1 1/2	900	5 5/8	13/4	47/8	5 3/4		Phenolic	216TM04101
4	1 1/2	900	5 5/8	13/4	47/8	5 3/4		Polyurethane/Alum.	216PD04101
5	1 1/2	480	6 1/2	15/8	5 1/4	7 1/2		Soft Rubber	216RR05101
5	1 1/2	600	6 1/2	15/8	5 1/4	8 1/2		Mold-on Rubber/Iron	216MR05101
5	1 1/2	600	6 1/2	15/8	5 1/4	6 1/2		Mold-on Rubber/Alu.	216MD05101
5	1 1/2	900	6 1/2	15/8	5 1/4	6 1/4		Polypropylene	216PB05101
5	1 1/2	900	6 1/2	15/8	5 1/4	6 1/2		Phenolic	216TM05101
5	1 1/2	900	6 1/2	15/8	5 1/4	6 1/4		Polyurethane/Alum.	216PD05101
6	1 1/2	540	7 1/4	15/8	5 3/4	9		Soft Rubber	216RR06101
6	1 1/2	900	7 1/4	15/8	5 3/4	7		Polypropylene	216PB06101
6	1 1/2	900	7 1/4	15/8	5 3/4	7		Phenolic	216TM06101
6	1 1/2	900	7 1/4	15/8	5 3/4	12		Polyurethane/Alum.	216PY06101
8	1 1/2	720	9 1/2	15/8	5 3/4	12		Soft Rubber	216RR08101

See 16 Series section on pages 24-26 for wheel appearance and descriptions.

216 CANTILEVER STYLE • CAPACITY TO 900

DUAL WHEEL CASTERS

263 Cantilever-Style Dual Wheel Casters

CAPACITY TO 2000



In most instances, these casters offer greater capacity, while maintaining the lowest possible overall height. Differential action helps to reduce scrubbing when changing directions. Because they are made from the single wheel caster rig, cantilever-style dual wheel casters can be field built.

MOUNTING OPTION

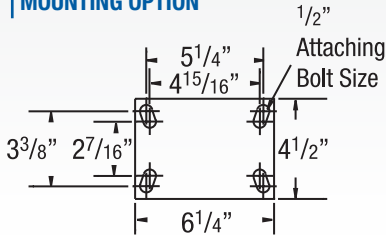

CANTILEVER KITS

Kit Number*	For Series	Axle Part Number Only
CK263000	63	ZJ08120004

Transform your standard 63 Series rig into a Dual Wheel caster with this field installable Cantilever Kit. *Kit includes the axle, nut, and spacers required to mount two wheels on a standard rig.

Field installable kits also available! See cantilever kits above.



Premium Quality



Environmentally Friendly

FEATURES

- **Top Plate:** 1/4" steel plate provides the strongest possible section for swivel bearing
- **Swivel Section:** 3-1/4" diameter load race. Raceways are coined smooth and then heat treated to minimize ball indentation and wear
- **Legs:** 3/8" steel plate formed to increase strength and welded to the yoke base inside and out
- **King Bolt:** 3/4" diameter heat treated king bolt and lock nut
- **Axle:** 3/4" diameter axle is hollow with lock nut
- **Lubrication:** Zerk fitting in swivel section and in recessed head of hollow axle
- **Notched Yoke Base:** Notched to accommodate swivel lock.
- See 63 Series section for features and mounting options
- Alternate or custom caster configurations available
- Note: 263 Series is a dual wheel 63 Series

BEARING OPTIONS



Straight Roller (01)



Pedestal Precision (29)

RIG OPTIONS

- **Face Contact Brake** specify **F**
- **Swivel Lock** (welded) specify **L**

+ For swivel models add "SK", for rigid model add "RK" to end of base caster number.

Wheel Diameter (Inches)	Tread Width (Inches)	Capacity (Lbs) (Rating for manual operation)	Overall Height (Inches)	Swivel Lead (Inches)	Swivel Radius (Inches)	Approx. Wt. (Lbs)	Wheel Type	Base Caster Number+ Roller Bearing (01)
263 Cantilever-Style Dual Wheel								
4	2	700	6	2 1/4	5 7/8	14	Mold-on Rubber/Iron	263MR04201
4	2	700	6	2 1/4	5 7/8	12	Mold-on Rubber/Alum.	263MD04201
4	2	700	6	2 1/4	5 7/8	10	X-tra Soft Rubber Flat Tread	263XS04201
4	2	1600	6	2 1/4	5 7/8	10 3/4	Phenolic	263TM04201
4	2	1600	6	2 1/4	5 7/8	10 3/4	Maxim	263NG04201
4	2	1400	6	2 1/4	5 7/8	10	Polyurethane/Alum.	263PD04201
4	2	1200	6	2 1/4	5 7/8	10	Polyurethane/Poly	263XA04201
5	2	600	6 1/2	2 1/4	6 3/4	11	White Nylon	263NW05201
5	2	750	6 1/2	2 1/4	6 3/4	13	X-tra Soft Rubber Flat Tread	263XS05201
5	2	800	6 1/2	2 1/4	6 3/4	14 1/4	Mold-on Rubber/Iron	263MR05201
5	2	800	6 1/2	2 1/4	6 3/4	13	Mold-on Rubber/Alum.	263MD05201
5	2	2000	6 1/2	2 1/4	6 3/4	12	Phenolic	263TM05201
5	2	2000	6 1/2	2 1/4	6 3/4	12	Maxim	263NG05201
5	2	2000	6 1/2	2 1/4	6 3/4	12	Polyurethane/Alum.	263PD05201
5	2	1300	6 1/2	2 1/4	6 3/4	11	Polypropylene	263PB05201
5	2	1500	6 1/2	2 1/4	6 3/4	11	Polyurethane/Poly	263XA05201
5	2	2000	6 1/2	2 1/4	6 3/4		Cast Iron (Heavy Duty)	263CH05201
5	2	2000	6 1/2	2 1/4	6 3/4	11	X-treme™ Solid Poly	263XI05201
6	2	820	7 1/2	2 1/4	6 3/4	18	Mold-on Rubber/Iron	263MR06201
6	2	820	7 1/2	2 1/4	6 3/4	14	Mold-on Rubber/ Alum.	263MD06201
6	2	900	7 1/2	2 1/4	6 3/4	11	White Nylon	263NW06201
6	2	900	7 1/2	2 1/4	6 3/4	14	X-tra Soft Round Tread	263XR06201
6	2	1200	7 1/2	2 1/4	6 3/4	14	X-tra Soft Flat Tread	263XS06201
6	2	2000	7 1/2	2 1/4	6 3/4	14	Phenolic	263TM06201
6	2	2000	7 1/2	2 1/4	6 3/4	14	Maxim	263NG06201
6	2	2000	7 1/2	2 1/4	6 3/4	13 3/4	Polyurethane/Alum.	263PD06201
6	2	1500	7 1/2	2 1/4	6 3/4	11	Polypropylene	263PB06201
6	2	1400	7 1/2	2 1/4	6 3/4	12	Polyurethane/Poly	263XA06201
6	2	2000	7 1/2	2 1/4	6 3/4	18	Cast Iron (Heavy Duty)	263CH06201
6	2	2000	7 1/2	2 1/4	6 3/4	12	X-treme™ Solid Poly	263XI06201
8	2	1000	10-1/8	2-1/4	7 1/2	21 1/2	Mold-on Rubber/Iron	263MR08201
8	2	1000	10-1/8	2-1/4	7 1/2	16	Mold-on Rubber/Alum.	263MD08201
8	2	1100	10-1/8	2-1/4	7 1/2	13	White Nylon	263NW08201
8	2	1200	10-1/8	2-1/4	7 1/2	16	X-tra Soft Round Tread	263XR08201
8	2	1350	10-1/8	2-1/4	7 1/2	16	X-tra Soft Flat Tread	263XS08201
8	2	2000	10-1/8	2-1/4	7 1/2	17	Phenolic	263TM08201
8	2	2000	10-1/8	2-1/4	7 1/2	17	Maxim	263NG08201
8	2	2000	10-1/8	2-1/4	7 1/2	14	Polyurethane/Alum.	263PD08201
8	2	2000	10-1/8	2-1/4	7 1/2	13	Polypropylene	263PB08201
8	2	2000	10-1/8	2-1/4	7 1/2		Cast Iron (Heavy Duty)	263CH08201
8	2	2000	10-1/8	2-1/4	7 1/2	14	X-treme™ Solid Poly	263XI08201

See 63 Series section on page 30 for wheel appearance and descriptions.

281

Cantilever-Style Dual Wheel Casters

CAPACITY TO 2000



Premium Quality



Environmentally Friendly

FEATURES

- **Top Plate:** Rugged AISI 1045 Drop forged steel for maximum strength
- **Swivel Section:** Double ball bearing coined "deep-groove" load and machined component thrust raceways
- **Legs:** 3/8" steel, engineered to increase strength and welded construction
- **King Bolt:** 3/4" diameter heat treated bolt and nut for enhanced load capacity
- **Axle:** 3/4" diameter, hollow, with lock nut
- **Lubrication:** Zerk fitting in swivel section and in recessed head of hollow axle
- See 81 Series section for features and mounting options
- Alternate or custom caster configurations available
- Note: 281 Series is a dual wheel 81 Series

BEARING OPTIONS



Straight Roller (05)



Precision Ball (28)

RIG OPTIONS

- **Face Contact Brake** specify **F**
- **Swivel Lock** (welded) specify **L**

+ For swivel models add "SK", for rigid model add "RK" to end of base caster number.

In most instances, these casters offer greater capacity, while maintaining the lowest possible overall height. Differential action helps to reduce scrubbing when changing directions. Because they are made from the single wheel caster rig, cantilever-style dual wheel casters can be field built.

MOUNTING OPTION

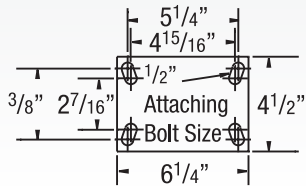

CANTILEVER KITS

Kit Number*	For Series	Axle Part Number Only
CK281000	81	ZJ121610

Transform your standard 81 Series rig into a Dual Wheel caster with this field installable Cantilever Kit. *Kit includes the axle, nut, and spacers required to mount two wheels on a standard rig

Field installable kits also available! See cantilever kits above.

Transform your standard 63 Series rig into a Dual Wheel caster with this field installable Cantilever Kit. *Kit includes the axle, nut, and spacers required to mount two wheels on a standard rig.

Wheel Diameter (Inches)	Tread Width (Inches)	Capacity (Lbs) (Based on minimal operation)	Overall Height (Inches)	Swivel Lead (Inches)	Swivel Radius (Inches)	Approx. Wt. (Lbs)	Wheel Type	Base Caster Number+ Roller Bearing (05), Precision Ball (28)
6	2-1/2	1080	7 ⁵ / ₈	1 1/2	6-5/8	28 1/2	Mold-on Rubber/Iron	281MR06405
6	2-1/2	2000	7 ⁵ / ₈	1 1/2	6-5/8	17 ³ / ₄	Phenolic	281TM06405
6	2-1/2	2000	7 ⁵ / ₈	1 1/2	6-5/8	26 ³ / ₄	Polyurethane/Iron	281PY06405
6	2-1/2	2000	7 ⁵ / ₈	1 1/2	6-5/8	26 ³ / ₄	Vulkollan/Iron	281VY06405
6	2-1/2	2000	7 ⁵ / ₈	1 1/2	6-5/8	26 ³ / ₄	Thick Tread Vulkollan/Iron	281VX06405
6	2-1/2	2000	7 ⁵ / ₈	1 1/2	6-5/8		Cast Iron	281CA06405
6	2-1/2	2000	7 ⁵ / ₈	1 1/2	6-5/8		Trinonix™	281NX06428
8	2-1/2	1700	10 ¹ / ₈	2 1/4	7 7/8	29 1/4	Mold-on Rubber/Iron	281MR08405
8	2-1/2	2000	10 ¹ / ₈	2 1/4	7 7/8	20 1/2	Phenolic	281TM08405
8	2-1/2	2000	10 ¹ / ₈	2 1/4	7 7/8	34	Polyurethane/Iron	281PY08405
8	2-1/2	2000	10 ¹ / ₈	2 1/4	7 7/8	34	Vulkollan/Iron	281VY08405
8	2-1/2	2000	10 ¹ / ₈	2 1/4	7 7/8	34	Thick Tread Vulkollan/Iron	281VX08405
8	2-1/2	2000	10 ¹ / ₈	2 1/4	7 7/8		Cast Iron	281CA08405
8	2-1/2	2000	10 ¹ / ₈	2 1/4	7 7/8		Trinonix™	281NX08428
10	2-1/2	1580	11 1/2	2 1/2	9	35	Mold-on Rubber/Iron	281MR10405
10	2-1/2	2000	11 1/2	2 1/2	9	24 1/2	Phenolic	281TM10405
10	2-1/2	2000	11 1/2	2 1/2	9	40	Polyurethane/Iron	281PY10405
10	2-1/2	2000	11 1/2	2 1/2	9	40	Vulkollan/Iron	281VY10405
10	2-1/2	2000	11 1/2	2 1/2	9	40	Thick Tread Vulkollan/Iron	281VX10405
10	2-1/2	2000	11 1/2	2 1/2	9		Cast Iron	281CA10405
10	2-1/2	2000	11 1/2	2 1/2	9		Trinonix™	281NX10428
12	2-1/2	1800	13 1/2	3	10 1/4	42	Mold-on Rubber/Iron	281MR12405
12	2-1/2	2000	13 1/2	3	10 1/4	31 1/4	Phenolic	281TM12405
12	2-1/2	2000	13 1/2	3	10 1/4	51	Polyurethane/Iron	281PY12405
12	2-1/2	2000	13 1/2	3	10 1/4		Cast Iron	281CA12405

See 81 Series section on pages 60-61 for wheel appearance and descriptions.

290 295

Cantilever-Style Dual Wheel Casters

CAPACITY TO 8000

290 Polyurethane/
Iron



In most instances, these casters offer greater capacity, while maintaining the lowest possible overall height. Differential action helps to reduce scrubbing when changing directions. Because they are made from the single wheel caster rig, cantilever-style dual wheel casters can be field built.

MOUNTING OPTION

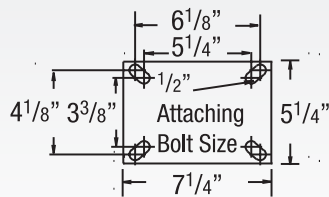

CANTILEVER KITS

Kit Number*	For Series	Axle Part Number Only
290 Kit ZJ121600	90	ZJ121600
295 Kit CK295000	95	ZJ201200

Transform your standard 90 or 95 Series rig into a Dual Wheel caster with this field installable Cantilever Kit.
*Kit includes the axle, nut, and spacers required to mount two wheels on a standard rig.

295 Phenolic



Field installable kits also available! See cantilever kits above.



Premium Quality



Environmentally Friendly

FEATURES

- 290 Series is a dual wheel version of our popular 90 Series. For full rig specifications, please see page 62.
- 295 Series is a dual wheel version of our popular 95 Series. For full rig specifications, please see page 72.

RIG OPTIONS

- **Face Contact Brake** specify **F**
- **Swivel Lock** (welded) specify **L**

BEARING OPTIONS



+ For swivel models add "SK", for rigid model add "RK" to end of base caster number.

Wheel Diameter (Inches)	Tread Width (Inches)	Capacity (Lbs) (Based on manual operation)	Overall Height (Inches)	Swivel Lead (Inches)	Swivel Radius (Inches)	Approx. Wt. (Lbs)	Wheel Type	Base Caster Number+ Roller (01), Precision Ball (28)
290 Cantilever-Style Dual Wheel								
8	3	1700	10 1/2	2 1/2	8 1/2	37 3/4	Mold-on Rubber/Iron	290MR08501
8	3	3500	10 1/2	2 1/2	8 1/2	28 1/4	Phenolic	290TM08501
8	3	2000	10 1/2	2 1/2	8 1/2		X-treme™ Plus Solid Poly	290XP08528
8	3	3500	10 1/2	2 1/2	8 1/2	45 1/4	Polyurethane/Iron	290PY08501
8	3	3500	10 1/2	2 1/2	8 1/2	45 1/4	Vulkollan/Iron	290VY08501
8	3	3500	10 1/2	2 1/2	8 1/2	45 1/4	Thick Tread Polyurethane/Iron	290PX08501
8	3	3500	10 1/2	2 1/2	8 1/2	45 1/4	Thick Tread Vulkollan/Iron	290VX08501
8	3	3500	10 1/2	2 1/2	8 1/2	45 1/4	Trionix™	290NX08528
10	3	2000	12 1/2	2 1/2	9 1/4	48	Mold-on Rubber/Iron	290MR10501
10	3	3500	12 1/2	2 1/2	9 1/4	34	Phenolic	290TM10501
10	3	2500	12 1/2	2 1/2	9 1/4	34	X-treme™ Plus Solid Poly	290XP10528
10	3	3500	12 1/2	2 1/2	9 1/4	51 1/2	Polyurethane/Iron	290PY10501
10	3	3500	12 1/2	2 1/2	9 1/4	51 1/2	Vulkollan/Iron	290VY10501
10	3	3500	12 1/2	2 1/2	9 1/4	51 1/2	Thick Tread Polyurethane/Iron	290PX10501
10	3	3500	12 1/2	2 1/2	9 1/4	51 1/2	Thick Tread Vulkollan/Iron	290VX10501
10	3	3500	12 1/2	2 1/2	9 1/4	51 1/2	Trionix™	290NX10528
12	3	2280	15 1/2	2 1/2	10 1/8	54	Mold-on Rubber/Iron	290MR12501
12	3	3500	15 1/2	2 1/2	10 1/8	38 1/2	Phenolic	290TM12501
12	3	3500	15 1/2	2 1/2	10 1/8	74 1/2	Polyurethane/Iron	290PY12501
12	3	3500	15 1/2	2 1/2	10 1/8	74 1/2	Thick Tread Polyurethane/Iron	290PX12501
295 Cantilever-Style Dual Wheel								
8	4	7000	11	2 1/4	10 1/4	88	Polyurethane/Iron	295PY08701
10	4	8000	13	2 1/2	11	102	Polyurethane/Iron	295PY10701
12	3 1/2	8000	15 1/2	2 1/2	11 3/4	105	Polyurethane/Iron	295PY12601
12	3 1/2	8000	15 1/2	2 1/2	12	86	Phenolic	295TM12601
12	4	8000	15 1/2	2 1/2	12	108	Polyurethane/Iron	295PY12701

See 90 Series section on pages 62-63 for wheel appearance and descriptions.

See 95 Series section on pages 72-74 for wheel appearance and descriptions.

115 Kingpinless Dual Wheel Casters

CAPACITY TO 2000



The 115 Series is a dual wheel version of our popular 110 Contender Kingpinless Series, with the addition of a third full leg for even greater durability. This remarkably durable dual wheel series provides easy turning and a sturdy footprint you can rely on.

MOUNTING OPTION

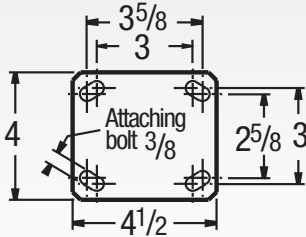

SWIVEL CROSS SECTION

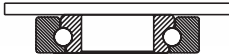

Premium Quality



Environmentally Friendly



Towing[^]

FEATURES

- **Top Plate:** 5/16" AISI 1045 steel welded and heat treated for longer life
- **Yoke Base:** Notched AISI 1045 steel
- **Swivel Section:** One row of 3/8" ball bearings mounted in a **heat treated** precision machined raceway. Zerk in swivel section
- **Axle:** 1/2" diameter hollow axle with zerk fitting on roller and tapered

bearing models (Solid axle on Delrin, precision ball, and Oilex models)

- **Finish:** Zinc plating
- See 110 Series section for features and mounting options
- Alternate or custom caster configurations available
- Note: 115 Series is a dual wheel 110 Series

BEARING OPTIONS



Straight Roller (01)

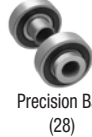

Precision Ball (28)



Pedestal Precision (29)

RIG OPTIONS



PLB Integrated Brake
specify **PLB**



Hand Operated Swivel Lock
specify **L**



Add **TOE** to end of Caster Number to specify integrated toe guard. Standard model toe guards are 1/2" from floor

+ For swivel models add "S", for rigid model add "R" to end of base caster number.

Wheel Diameter (Inches)	Tread Width (Inches)	Capacity (Lbs) <small>(Rolls for normal operation)</small>	Overall Height (Inches)	Swivel Lead (Inches)	Wheel Type	Base Caster Number+ Roller Bearing (01), Precision Ball (28)
115 Kingpinless Dual Wheel						
4	2	600	57/8	1.188	Mold-on Rubber/Iron	115MR04201
4	2	600	57/8	1.188	Mold-on Rubber/Aluminum	115MD04201
4	2	1000	57/8	1.188	Cast Iron	115CA04201
4	2	1600	57/8	1.188	Phenolic	115TM04201
4	2	2000	57/8	1.188	Polyurethane/Aluminum	115PD04201
4	2	2000	57/8	1.188	Trionix™	115NX04228
5	2	900	63/4	1.375	Mold-on Rubber/Iron	115MR05201
5	2	900	63/4	1.375	Mold-on Rubber/Aluminum	115MD05201
5	2	2000	63/4	1.375	Phenolic	115TM05201
5	2	2000	63/4	1.375	Cast Iron	115CA05201
5	2	2000	63/4	1.375	Polyurethane/Alum.	115PD05201
5	2	2000	63/4	1.375	Trionix™	115NX05228
6	2	1000	73/4	1.563	Mold-on Rubber/Iron	115MR06201
6	2	1000	73/4	1.563	Mold-on Rubber/Aluminum	115MD06201
6	2	2000	73/4	1.563	Cast Iron	115CA06201
6	2	2000	73/4	1.563	Phenolic	115TM06201
6	2	2000	73/4	1.563	Polyurethane/Aluminum	115PD06201
6	2	2000	73/4	1.563	Trionix™	115NX06228
8	2	1200	101/8	2.250	Mold-on Rubber/Iron	115MR08201
8	2	1200	101/8	2.250	Mold-on Rubber/Aluminum	115MD08201
8	2	2000	101/8	2.250	Cast Iron	115CA08201
8	2	2000	101/8	2.250	Phenolic	115TM08201
8	2	2000	101/8	2.250	Polyurethane/Aluminum	115PD08201
8	2	2000	101/8	2.250	Trionix™	115NX08228

See 110 Series section on pages 42-44 for wheel appearance and descriptions.

115 KINGPINLESS • CAPACITY TO 2000

DUAL WHEEL CASTERS

[^]Towing: Consult factory prior to ordering to ensure selection supports your towing requirement

315

Kingpinless Dual Wheel Casters CAPACITY TO 4100

Made in the USA



The 315 Series is a dual wheel version of our popular 310 Contender Kingpinless Series, with the addition of a third full leg for even greater durability. This remarkably durable dual wheel series provides easy turning and a sturdy footprint you can rely on.

MOUNTING OPTION

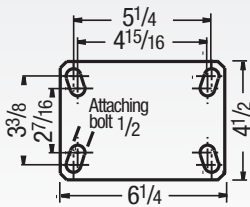

SWIVEL CROSS SECTION



FEATURES

- New laser-cut steel rigs and many wheels now **Made in the USA**
- **3 Year** warranty
- **Top Plate:** 5/16" AISI 1045 heat treated steel welded inside and out for longer life
- **Swivel Section:** One row of 1/2" ball bearings mounted in a heat treated precision machined raceway. Zerk in swivel section
- **Yoke Base:** Notched AISI 1045 steel
- **Legs:** 3/8" thick welded inside and out
- **Axle:** 1/2" diameter axle for 6" and 8" models, 3/4" diameter axle for 10" and 12" models
- **Finish:** RoHS Zinc plating, for greater corrosion resistance than paint
- See 310 Series section for features and mounting options.
- Alternate or custom caster configurations available
- Note: 315 Series is a dual wheel 310 Series

RIG OPTIONS



PLB Integrated specify **PLB**



Hand Operated Swivel Lock specify **L**



Add **TOE** to end of Caster Number to specify integrated toe guard. Standard model toe guards are 1/2" from floor.

BEARING OPTIONS

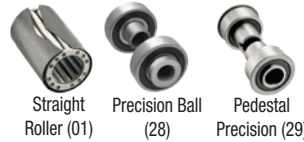

+ For swivel models add "S", for rigid model add "R" to end of base caster number.

Wheel Diameter (Inches)	Tread Width (Inches)	Capacity (lbs) (Based on manual operation)	Overall Height (Inches)	Swivel Lead (Inches)	Wheel Type	Base Caster Number+ Roller Bearing (01), Precision Ball (28)
315 Kingpinless Dual Wheel						
6	2	1200	8.00	1.56	X-tra Soft Rubber Flat Tread	315XS06201
6	2	4100	8.00	1.56	Drop Forged	315FS06201
6	2	4100	8.00	1.56	Cast Iron	315CA06201
6	2	2000	8.00	1.56	Phenolic	315TM06201
6	2	2000	8.00	1.56	Polyurethane/Aluminum	315PD06201
6	2	2000	8.00	1.56	Polyurethane/Iron	315PY06201
6	2	2000	8.00	1.56	Polyurethane Round Tread	315PM06228
6	2	2000	8.00	1.56	Cast Iron (Heavy Duty)	315CH06201
6	2	2000	8.00	1.56	Trionix™	315NX06228
8	2	1350	10.13	2.13	X-tra Soft Rubber Flat Tread	315XS08201
8	2	2000	10.13	2.13	Cast Iron	315CA08201
8	2	2000	10.13	2.13	Phenolic	315TM08201
8	2	2000	10.13	2.13	Polyurethane/Aluminum	315PD08201
8	2	2000	10.13	2.13	Polyurethane/Iron	315PY08201
8	2	2000	10.13	2.13	Polyurethane (Round Tread)	315PM08228
8	2	2000	10.13	2.13	Trionix™	315NX08228
8	2	2000	10.13	2.13	Cast Iron (Heavy Duty)	315CH08201
10	3	4100	12.00	2.25	Drop Forged	315FS10501
10	3	4100	12.00	2.25	Cast Iron	315CA10501
10	3	4100	12.00	2.25	Phenolic	315TM10501
10	3	4100	12.00	2.25	Polyurethane/Iron	315PY10501
10	3	4100	12.00	2.25	Trionix™	315NX10528
10	3	4100	12.00	2.25	Vulkollan	315VY10528
12	3	4100	14.00	2.69	Drop Forged	315FS12501
12	3	4100	14.00	2.69	Cast Iron	315CA12501
12	3	4100	14.00	2.69	Phenolic	315TM12501
12	3	4100	14.00	2.69	Polyurethane/Iron	315PY12501
12	3	4100	14.00	2.69	Polyurethane/Iron	315PX12501

415 615

Kingpinless Dual Wheel Casters CAPACITY TO 12000

Made in the USA

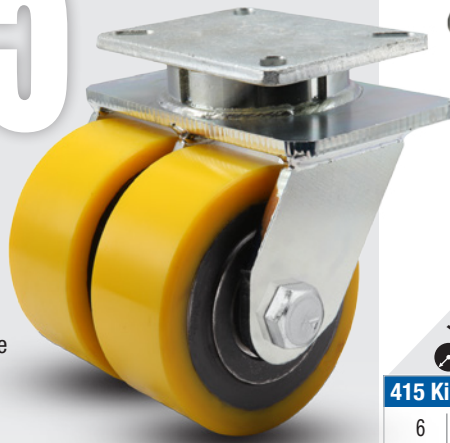

415 Polyurethane on Iron (PF)

The 415 and 615 Series are dual wheel versions of our popular 410 and 610 Contender Kingpinless Series, with the addition of a third full leg for even greater durability. These remarkably durable dual wheel series provide easy turning and a sturdy footprint you can rely on.

415 MOUNTING OPTION

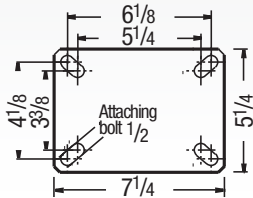

415 SWIVEL CROSS SECTION

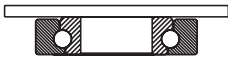

615 MOUNTING OPTION

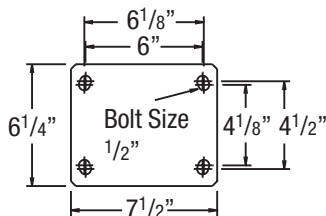

615 SWIVEL CROSS SECTION

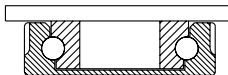

FEATURES

- New laser-cut steel rigs and many wheels now **Made in the USA**
- See 410 (page 50) and 610 Series section (page 52) for features and mounting options

BEARING OPTIONS

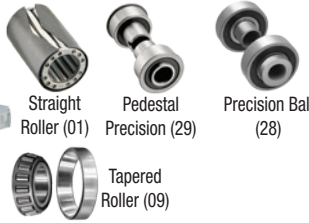

RIG OPTIONS



PLB Integrated specify **PLB**

Hand Operated Swivel Lock specify **L**



Add **TOE** to end of Caster Number to specify integrated toe guard. Standard model toe guards are 1/2" from floor

+ For swivel models add "S", for rigid model add "R" to end of base caster number.

Wheel Diameter (Inches)	Tread Width (Inches)	Capacity (Lbs) (Based on normal operation)	Overall Height (Inches)	Swivel Lead (Inches)	Wheel Type	Base Caster Number+ Roller Bearing (01), Precision Ball (28)	Base Caster Number+ Tapered Roller Bearing (09)
415 Kingpinless Dual Wheel							
6	3	4000	8	2.25	Phenolic	415TM06501	415TM06509
6	3	4080	8	2.25	Polyurethane/Iron (Green)	415PY06501	415PY06509
6	3	5400	8	2.25	Cast Iron	415CA06501	415CA06509
6	3	5400	8	2.25	Trionix™	415NX06528	
6	3	5400	8	2.25	Polyurethane/Iron (Yellow)	415PF06528	
8	3	1800	10 1/2	2.75	Mold-on Rubber/Iron	415MR08501	415MR08509
8	3	5040	10 1/2	2.75	Polyurethane/Iron (Green)	415PY08501	415PY08509
8	3	5400	10 1/2	2.75	Polyurethane/Iron (Yellow)	415PF08528	
8	3	5000	10 1/2	2.75	Phenolic	415TM08501	415TM08509
8	3	5400	10 1/2	2.75	Cast Iron	415CA08501	415CA08509
8	3	5400	10 1/2	2.75	Trionix™	415NX08528	
10	3	2000	12 1/2	3.38	Mold-on Rubber/Iron	415MR10501	415MR10509
10	3	5400	12 1/2	3.38	Polyurethane/Iron (Green)	415PY10501	415PY10509
10	3	5400	12 1/2	3.38	Polyurethane/Iron (Yellow)	415PF10528	
10	3	5400	12 1/2	3.38	Phenolic	415TM10501	415TM10509
10	3	5400	12 1/2	3.38	Cast Iron	415CA10501	415CA10509
10	3	5400	12 1/2	3.38	Trionix™	415NX10528	
12	3	5400	15 1/2	4.13	Polyurethane/Iron (Green)	415PY12501	415PY12506
12	3	5400	15 1/2	4.13	Polyurethane/Iron (Yellow)	415PF12528	
12	3	5400	15 1/2	4.13	Phenolic	415TM12501	415TM12509
12	3	5400	15 1/2	4.13	Cast Iron	415CA12501	415CA12509

See 410 Series section on pages 50-51 for wheel appearance and descriptions.

615 Kingpinless Dual Wheel

6	3	7200	8 1/2	2 1/2	Trionix™	615NX06528	
6	3	7600	8 1/2	2 1/2	Polyurethane/Iron (Yellow)	615PF06528	
6	3	10000	8 1/2	2 1/2	Drop Forged	615FS06501	615FS06509
8	3	10000	10 1/2	2 1/2	Laminated Phenolic		615TL08509
8	3	5040	10 1/2	2 1/2	Polyurethane/Iron	615PH08501	615PY08509
8	3	7200	10 1/2	2 1/2	Trionix™	615NX08528	
8	3	8000	10 1/2	2 1/2	Polyurethane/Iron (Yellow)	61PF08528	
8	3	5040	10 1/2	2 1/2	Polyurethane/Iron	615PH08501	615PY08509
8	4	7000	10 1/2	2 1/2	Polyurethane/Iron	615PY08701	615PY08709
10	3	10000	12 1/2	2 1/2	Laminated Phenolic		615TL10509
10	3	6000	12 1/2	2 1/2	Polyurethane/Iron	615PH10501	615PY10509
10	3	7200	12 1/2	2 1/2	Trionix™	615NX10528	
10	3	8400	12 1/2	2 1/2	Polyurethane/Iron (Yellow)	615PF10528	
10	3	10000	12 1/2	2 1/2	Drop Forged	615FH10501	615FH10509
10	4	10000	12 1/2	2 1/2	Drop Forged		615FH10709
10	4	8400	12 1/2	2 3/4	Polyurethane/Iron	615PY10701	615PY10709
10	5	10000	12 1/2	2 3/4	Polyurethane/Iron	615PY10801	615PY10809
12	3	6840	15 1/2	2 1/2	Polyurethane/Iron	615PH12501	615PY12509
12	3-1/2	10000	15 1/2	2 1/2	Ductile Iron	615FM12601	615FM12609
12	3-1/2	10000	15 1/2	2 1/2	Laminated Phenolic	615TL12601	615TL12609
12	3-1/2	8220	15 1/2	2 1/2	Polyurethane/Iron	615PY12601	615PY12609
12	3-1/2	8000	15 1/2	2 1/2	Phenolic	615TM12601	615TM12609
12	4	9600	15 1/2	2 1/2	Polyurethane/Iron	615PY12701	615PY12709
12	5	12000	15 1/2	2 1/2	Polyurethane/Iron		615PY12809

See 610 Series section on pages 52-53 for wheel appearance and descriptions.

850

Shockmaster Kingpinless Dual Wheel Casters

CAPACITY TO 30000



Premium Quality



Environmentally Friendly



Towing^

FEATURES

- **Top Plate:** 3/4" thick AISI 1045 steel one-piece forging precision machined and through-hardened for long life
- **Yoke Base:** AISI 1045 steel forging welded using 100,000 psi weld filler to 3/4" thick adapter plate
- **Swivel Section:** 7/8" ball bearings mounted in a 7" diameter precision machined raceway. Zerk in swivel section
- **Legs:** 3/4" thick through-hardened steel welded to yoke base using 100,000 psi weld filler
- **Axle:** 1-1/4" diameter
- Alternate or custom caster configurations available

RIG OPTIONS

- Notched yoke base for swivel locks specify **NY850**
- Spring-loaded models available, consult factory. Single models available also

BRAKE OPTIONS

Face Contact specify **F**



Hand Operated Detachable Swivel Lock specify **L**



Hand Operated Swivel Lock specify **SL8000000**

BEARING OPTIONS



Straight Roller (01)



Tapered Roller (09)

This dual wheel caster has been designed with features tailored to meet the varied needs of the aviation ground support equipment industry. 850 Series are equally at home in many other extremely abusive and rugged applications.

TYPICAL APPLICATIONS

- Custom applications
- Towable transportation equipment
- Aircraft wing jacks and dollies
- Aircraft assembly fixtures
- Aircraft work platform stands

SWIVEL CROSS SECTION



MOUNTING OPTION

Swivel Top Plate

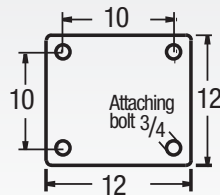

Rigid Top Plate

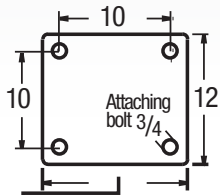

- 10" for 3" Wide Wheels
- 15-3/8" for 4 to 5" Wide Wheels
- 17-1/4" for 6" Wide Wheels
- 23-1/4" for 9" Wide Wheels

+ For swivel models add "S", for rigid model add "R" to end of base caster number.

WHEN FAILURE IS NOT AN OPTION...

The preferred caster for the aviation and group support industry – able to handle your most abusive application!

Wheel Diameter (Inches)	Tread Width (Inches)	Capacity (Lbs) (Based on normal operation)	Overall Height (Inches)	Swivel Lead (Inches)	Wheel Type	Base Caster Number+ Roller Bearing (01), Tapered Roller Bearing (09)
850 Shockmaster Kingpinless Dual Wheel						
6	3	30000	11	3 1/4	HD Drop Forged	850FH06509
10	4	30000	14 3/4	3 1/4	HD Drop Forged	850FH10709
12	4	3200	15 3/4	3 1/4	Moldon Rubber/Iron Core	850MR12701
12	4	9600	15 3/4	3 1/4	Polyurethane/Iron Core	850PY12701
12	4	9600	15 3/4	3 1/4	Thick Tread Polyurethane	850PX12701
12	4 1/2	6600	15 3/4	3 1/4	Press-on Polyurethane	850OG12709
12	5	12000	15 3/4	3 1/4	Thick Tread Polyurethane	850PX12801
12	6	15000	15 3/4	3 1/4	Polyurethane/Aluminum	850PA12909
16	4	4000	19 3/4	4 1/2	Moldon Rubber/Iron Core	850MR16701
16	4	11940	19 3/4	4 1/2	Polyurethane/Iron Core	850PY16701
16	4	11940	19 3/4	4 1/2	Thick Tread Polyurethane	850PX16701
16	5	5140	19 3/4	4 1/2	Moldon Rubber/Iron Core	850MR16801
16	5	15400	19 3/4	4 1/2	Polyurethane/Iron Core	850PY16801
16	5	15400	19 3/4	4 1/2	Thick Tread Polyurethane	850PX16801
18	5	5600	22	5 1/4	Moldon Rubber/Iron Core	850MR18801
18	5	16800	22	5 1/4	Polyurethane/Iron Core	850PY18801
18	5	10340	22	4 1/2	Press-on Polyurethane	850OG18809
18	9	20000	22	4 1/2	Press-on Polyurethane	850OG18909

272 281

Standard Kingpin Dual Wheel Casters

CAPACITY TO 2000



272 Cast Iron

Designed for greater capacity and better distribution of floor load with lowest possible overall height. These casters have differential action when changing direction, thus greatly reducing the scrubbing effect resulting from use of wide faced, small diameter wheels.

272 MOUNTING OPTION

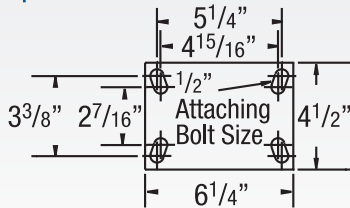

281 MOUNTING OPTION

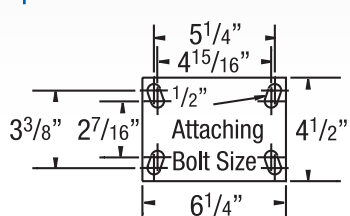

FEATURES

- See 72 and 81 Series section for features and mounting options.

(Note 272 Series is a dual wheel 72 Series, 281 is dual wheel 81 series)



281 Drop Forged Steel

BEARING OPTIONS

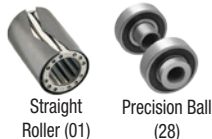

Straight Roller (01)

Precision Ball (28)



Premium Quality



Environmentally Friendly

+ For swivel models add "S", for rigid model add "R" to end of base caster number.

Wheel Diameter (Inches)	Tread Width (Inches)	Capacity (Lbs) (Based on normal operation)	Overall Height (Inches)	Swivel Lead (Inches)	Approx. Wt. (Lbs)	Wheel Type	Base Caster Number+ Roller Bearing (01), Precision Ball (28)
272 Standard Kingpin Dual Wheel							
3 1/4	1 1/2	680	5 1/4	1 7/16	9	Mold-on Rubber/Iron	272MH03101
3 1/4	1 1/2	800	5 1/4	1 7/16	8 1/2	Cast Iron	272CA03101
3 1/4	1 5/8	840	5 1/4	1 7/16	8 1/2	Polyurethane/Iron	272PY03101
3 1/4	1 1/2	1200	5 1/4	1 7/16	8 1/2	Phenolic	272TM03101
4	1 1/2	500	5 5/8	1 7/16	9 1/4	Mold-on Rubber/Iron	272MR04101
4	1 1/2	500	5 5/8	1 7/16	9 1/2	Mold-on Rubber/Alum.	272MD04101
4	1 1/2	1200	5 5/8	1 7/16	11 1/2	Cast Iron	272CA04101
4	1 1/2	1200	5 5/8	1 7/16	9	Phenolic	272TM04101
4	1 1/2	1200	5 5/8	1 7/16	9	Polyurethane/Alum.	272PD04101
5	1 1/2	600	6 1/2	1 13/16	10	Mold-on Rubber/Iron	272MR05101
5	1 1/2	600	6 1/2	1 13/16	9 1/2	Mold-on Rubber/Alum.	272MD05101
5	1 1/2	1200	6 1/2	1 13/16	10	Phenolic	272TM05101
5	1 1/2	1200	6 1/2	1 13/16	13 1/4	Cast Iron	272CA05101
5	1 1/2	1440	6 1/2	1 13/16	9 3/4	Polyurethane/Alum.	272PD05101

See 72 Series section on page 33-34 for wheel appearance and descriptions.

281 Standard Kingpin Dual Wheel

4	1 1/2	2000	5 1/2	2 1/4	14	Drop Forged	281FS04101
4	2	700	5 1/2	2 1/4	10 1/2	Mold-on Rubber/Alum.	281MD04201
4	2	700	5 1/2	2 1/4	10 3/4	Mold-on Rubber/Iron	281MR04201
4	2	700	5 1/2	2 1/4	10 3/4	X-tra Soft Flat Tread	281XS04201
4	2	1200	5 1/2	2 1/4	10 1/2	Poly/Polypropylene	281XA04201
4	2	1400	5 1/2	2 1/4	14	Cast Iron	281CA04201
4	2	1600	5 1/2	2 1/4	10 1/4	Phenolic	281TM04201
4	2	1600	5 1/2	2 1/4	10 1/4	Maxim®	281NG04201
4	2	1400	5 1/2	2 1/4	10 1/2	Polyurethane/Alum.	281PD04201
4	2	2000	5 1/2	2 1/4		Trionix™	281NX04228
5	1 3/4	2000	6 1/2	2 1/4	16 1/4	Drop Forged	281FS05201
5	2	750	6 1/2	2 1/4	11 1/2	X-tra Soft Flat Tread	281XS05201
5	2	800	6 1/2	2 1/4	11 1/2	Mold-on Rubber/Iron	281MR05201
5	2	1500	6 1/2	2 1/4	9 1/2	Poly/Polypropylene	281XA05201
5	2	2000	6 1/2	2 1/4	18	Cast Iron	281CA05201
5	2	2000	6 1/2	2 1/4	11 1/4	Phenolic	281TM05201
5	2	2000	6 1/2	2 1/4	11 1/4	Maxim®	281NG05201
5	2	2000	6 1/2	2 1/4		Polyurethane/Iron	281PI05201
5	2	2000	6 1/2	2 1/4	10 3/4	Polyurethane/Alum.	281PD05201
5	2	2000	6 1/2	2 1/4	10 3/4	Round Tread Polyurethane/Alum.	281PM05228
5	2	2000	6 1/2	2 1/4	20	Cast Iron (Heavy Duty)	281CH05201
5	2	2000	6 1/2	2 1/4		Trionix™	281NX05228
6	2	820	7 1/2	2 1/4	12 3/4	Mold-on Rubber/Iron	281MR06201
6	2	1200	7 1/2	2 1/4	10	X-tra Soft Rubber Flat Tread	281XS06201
6	2	1800	7 1/2	2 1/4	10	Poly/Polypropylene	281XA06201
6	2	2000	7 1/2	2 1/4	20	Drop Forged	281FS06201
6	2	2000	7 1/2	2 1/4	20 1/4	Cast Iron	281CA06201
6	2	2000	7 1/2	2 1/4	11 3/4	Phenolic	281TM06201
6	2	2000	7 1/2	2 1/4	11 3/4	Maxim®	281NG06201
6	2	2000	7 1/2	2 1/4	13	Polyurethane/Alum.	281PD06201
6	2	2000	7 1/2	2 1/4		Polyurethane/Iron	281PI06201
6	2	2000	7 1/2	2 1/4	20	Polyurethane Round Tread	281PM06228
6	2	2000	7 1/2	2 1/4	21	Cast Iron (Heavy Duty)	281CH06201
6	2	2000	7 1/2	2 1/4		Trionix™	281NX06228
8	2	1000	10 1/8	2 1/4	13 3/4	Mold-on Rubber/Iron	281MR08201
8	2	1350	10 1/8	2 1/4	10 1/2	X-tra Soft Rubber Flat Tread	281XS08201
8	2	2000	10 1/8	2 1/4	14 1/4	Cast Iron	281CA08201
8	2	2000	10 1/8	2 1/4	16	Phenolic	281TM08201
8	2	2000	10 1/8	2 1/4	16	Maxim®	281NG08201
8	2	2000	10 1/8	2 1/4	25 1/4	Polyurethane/Alum.	281PD08201
8	2	2000	10 1/8	2 1/4		Polyurethane/Iron	281PI08201
8	2	2000	10 1/8	2 1/4	14	Polyurethane (Round Tread)	281PM08228
8	2	2000	10 1/8	2 1/4	10 1/4	Poly/Polypropylene	281XA08201
8	2	2000	10-1/8	2-1/4	15	Cast Iron (Heavy Duty)	281CH08201
8	2	2000	10-1/8	2-1/4	16	Trionix™	281NX08228

See 81 Series section on pages 60-61 for wheel appearance and descriptions.

290 292 293

Standard Kingpin Dual Wheel Casters

CAPACITY TO 7500



These series are designed for greater capacity and better distribution of floor load with lowest possible overall height. These casters have differential action when changing direction, thus greatly reducing the scrubbing effect resulting from use of wide faced, small diameter wheels.

290 MOUNTING OPTION

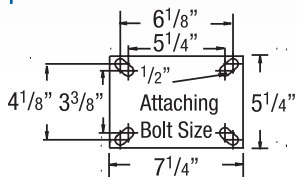

292 MOUNTING OPTION

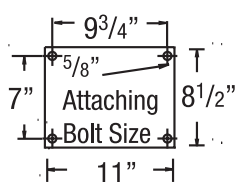

293 MOUNTING OPTION

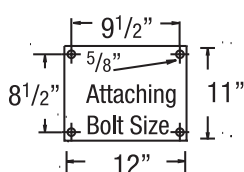

FEATURES

- See 90 (page 62), 92 (page 64) and 93 (page 66) Series section for features and mounting options.

BEARING OPTIONS



+ For swivel models add "S", for rigid model add "R" to end of base caster number.

Wheel Diameter (Inches)		Tread Width (Inches)		Capacity (Lbs) (Based on manual operation)		Overall Height (Inches)		Swivel Lead (Inches)		Approx. Wt. (Lbs)		Wheel Type	Base Caster Number+ Roller Bearing (01), (05), Precision (28)	Base Caster Number+ Tapered Roller Bearing (09)			
290 Standard Kingpin Dual Wheel																	
6	2 1/2	1080	8	2 1/4	36 1/2	Mold-on Rubber/Iron	290MR06405		6	2 1/2	3200	8	2 1/4	26 1/4	Phenolic	290TM06405	
6	2 1/2	3240	8	2 1/4	38	Polyurethane/Iron	290PY06405		6	2 1/2	3500	8	2 1/4	37	Cast Iron	290CA06405	
6	2 1/2	3500	8	2 1/4		Trionix™	290NX06428		8	2 1/2	1340	10 1/2	2 1/2	37 3/4	Mold-on Rubber/Iron	290MR08405	
8	2 1/2	3500	10 1/2	2 1/2	30 1/4	Polyurethane/Iron	290PY08405		8	2 1/2	3500	10 1/2	2 1/2	42 3/4	Phenolic	290TM08405	
8	2 1/2	3500	10 1/2	2 1/2	44 1/2	Cast Iron	290CA08405		8	2 1/2	3500	10 1/2	2 1/2		Trionix™	290NX08428	
10	2 1/2	1580	12 1/2	2 1/2	45	Mold-on Rubber/Iron	290MR10405		10	2 1/2	3500	12 1/2	2 1/2	52 1/4	Polyurethane/Iron	290PY10405	
10	2 1/2	3500	12 1/2	2 1/2	34 1/2	Phenolic	290TM10405		10	2 1/2	3500	12 1/2	2 1/2	53 1/4	Cast Iron	290CA10405	
10	2 1/2	3500	12 1/2	2 1/2		Trionix™	290NX10428		12	2 1/2	1800	14	2 1/2	43	Mold-on Rubber/Iron	290MR12405	
12	2 1/2	3500	14	2 1/2	64 1/2	Polyurethane/Iron	290PY12405		12	2 1/2	3500	14	2 1/2	61	Phenolic	290TM12405	
12	2 1/2	3500	14	2 1/2	51 3/4	Cast Iron	290CA12405										
292 Standard Kingpin Dual Wheel																	
8	3	1680	11	3	62 1/2	Mold-on Rubber/Iron	292MR08501	292MR08509	8	3	2000	11	3		X-treme™ Plus Solid Poly	292XP08528	
8	3	4800	11	3	76	Drop Forged	292FS08501	292FS08509	8	3	4800	11	3	71	Polyurethane/Iron	292PY08501	292PY08509
8	3	4800	11	3	54	Phenolic	292TM08501	292TM08509	8	3	4800	11	3	62 3/4	Cast Iron	292CA08501	292CA08509
8	3	4800	11	3		Trionix™	292NX08528		10	3	2000	12 7/8	3	67 3/4	Mold-on Rubber/Iron	292MR10501	292MR10509
10	3	4800	12 7/8	3	94 3/4	Drop Forged	292FS10501	292FS10509	10	3	4800	12 7/8	3	79 1/2	Polyurethane/Iron	292PY10501	292PY10509
10	3	4800	12 7/8	3	59	Phenolic	292TM10501	292TM10509	10	3	4800	12 7/8	3		X-treme™ Plus Solid Poly	292XP10528	
10	3	2500	12 7/8	3			292CA10501	292CA10509	10	3	4800	12 7/8	3	73	Cast Iron	292CA10501	292CA10509
10	3	4800	12 7/8	3		Trionix™	292NX10528		12	3	2280	14 7/8	3	78 1/2	Mold-on Rubber/Iron	292MR12501	292MR12509
12	3	4800	14 7/8	3	96	Polyurethane/Iron	292PY12501	292PY12509	12	3	4800	14 7/8	3	65 3/4	Phenolic	292TM12501	292TM12509
12	3	4800	14 7/8	3	84 1/4	Cast Iron	292CA12501	292CA12509									
293 Standard Kingpin Dual Wheel																	
10	4	2800	12 3/4	4	118 3/4	Mold-on Rubber/Iron	293MR10701	293MR10709	10	4	7500	12 3/4	4	126 1/2	Polyurethane/Iron	293PY10701	293PY10709
12	3-1/2	7500	15 3/4	4	150 1/2	Ductile Iron	293FM12601	293FM12609	12	3-1/2	7500	15 3/4	4	130 1/2	Polyurethane/Iron	293PY12601	293PY12609
12	3-1/2	7500	15 3/4	4	140 1/2	Cast Iron	293CA12601	293CA12609	12	4	3200	15 3/4	4	128 1/2	Mold-on Rubber/Iron	293MR12701	293MR12709
16	4	3980	19	4	170 1/2	Mold-on Rubber/Iron	293MR16701		16	4	7500	19	4	209	Polyurethane/Iron	293PY16701	293PY16709
16	4	7500	19	4	145 1/2	Phenolic	293TM16701		16	5	5140	19	4	196 1/2	Mold-on Rubber/Iron	293MR16801	
16	5	7500	19	4	237 1/2	Polyurethane/Iron	293PY16801	293PY16809	18	5	5600	21	4	244 1/4	Mold-on Rubber/Iron	293MR18801	

295 Standard Kingpin Dual Wheel Casters

CAPACITY TO 17000



Premium Quality



Environmentally Friendly

FEATURES

- **Top Plate and Yoke Base:** 5/8" thick AISI 1045 drop-forged steel for extended life
- **Swivel Load Bearings:** 7" diameter machined for smooth swivel and extended wear
- **Component Thrust Bearing:** 1-1/4" tapered roller bearing
- **Legs:** 1/2" formed steel plate welded inside and out to yoke base
- **King Bolt:** Integrally forged with top plate
- **Axle:** 1-1/4" solid axle with locking nut
- See additional details of 95 BBL on page 72
- See additional details of 95 TRL on page 73
- Alternate or custom caster configurations available

+ Swivel Caster Numbers shown; for rigid change SBBL to R in Caster Number.

295 Series is designed for greater capacity and better distribution of floor load with lowest possible overall height. These casters have differential action when changing direction, thus greatly reducing the scrubbing effect resulting from use of wide faced, small diameter wheels.

MOUNTING OPTION

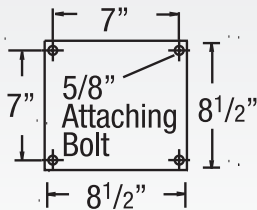

BEARING OPTIONS



Straight Roller (01)

Tapered Roller (09)

Wheel Diameter (Inches)	Tread Width (Inches)	Capacity (Lbs) (Based on normal operation)	Overall Height (Inches)	Swivel Lead (Inches)	Approx. Wt. (Lbs)	Wheel Type	Base Caster Number+ Roller Bearing (01)	Base Caster Number+ Tapered Roller Bearing (09)
295BBL Series (Ball Load Swivel Section)								
6	3	8000	9	2 1/4	83	Drop Forged	295FS06501SBBL	295FS06509SBBL
8	3	5000	11	2 1/2	56	Laminated Phenolic		295TL08509SBBL
8	3	5040	11	2 1/2	78	Polyurethane/Iron	295PH08501SBBL	295PY08509SBBL
8	4	7000	11	2 1/2	91	Polyurethane/Iron	295PY08701SBBL	295PY08709SBBL
10	3	5800	13	2 1/2	64	Laminated Phenolic		295TL10509SBBL
10	3	6000	13	2 1/2	87	Polyurethane/Iron	295PH10501SBBL	295PY10509SBBL
10	3	8000	13	2 1/2	120	Drop Forged	295FH10501SBBL	295FH10509SBBL
10	4	8000	13	2 1/2	136	Drop Forged		295FH10709SBBL
10	4	8000	13	2 3/4	104	Polyurethane/Iron	295PY10701SBBL	295PY10709SBBL
10	5	8000	13	2 3/4	127	Polyurethane/Iron	295PY10801SBBL	295PY10809SBBL
12	3	6840	15 1/2	2 1/2	105	Polyurethane/Iron	295PH12501SBBL	295PY12509SBBL
12	3-1/2	8000	15 1/2	2 1/2	128	Ductile Iron	295FM12601SBBL	295FM12609SBBL
12	3-1/2	8000	15 1/2	2 1/2	94	Laminated Phenolic	295TL12601SBBL	295TL12609SBBL
12	3-1/2	8000	15 1/2	2 1/2	108	Polyurethane/Iron	295PY12601SBBL	295PY12609SBBL
12	3-1/2	8000	15 1/2	2 1/2	94	Phenolic	295TM12601SBBL	295TM12609SBBL
12	4	8000	15 1/2	2 1/2	114	Polyurethane/Iron	295PY12701SBBL	295PY12709SBBL
12	5	8000	15 1/2	2 1/2	141	Polyurethane/Iron		295PY12809SBBL

Wheel Diameter (Inches)	Tread Width (Inches)	Capacity (Lbs) (Based on normal operation)	Overall Height (Inches)	Swivel Lead (Inches)	Approx. Wt. (Lbs)	Wheel Type	Base Caster Number+ Roller Bearing (01)	Base Caster Number+ Tapered Roller Bearing (09)
295TRL Series (Precision Tapered Roller Bearing Swivel Section)								
6	3	17000	9	2 1/4	83	Drop Forged	295FS06501STRL	295FS06509STRL
8	3	5000	11	2 1/2	56	Laminated Phenolic		295TL08509STRL
8	3	5040	11	2 1/2	78	Polyurethane/Iron	295PY08501STRL	295PY08509STRL
8	4	7000	11	2 1/2	91	Polyurethane/Iron	295PY08701STRL	295PY08709STRL
10	3	5800	13	2 1/2	64	Laminated Phenolic		295TL10509STRL
10	3	6000	13	2 1/2	87	Polyurethane/Iron	295PH10501STRL	295PY10509STRL
10	3	17000	13	2 1/2	120	Drop Forged	295FH10501STRL	295FH10509STRL
10	4	8400	13	2 3/4	10	Polyurethane/Iron	295PY10701STRL	295PY10709STRL
10	4	17000	13	2 1/2	136	Drop Forged		295FH10709STRL
10	5	10000	13	2 3/4	127	Polyurethane/Iron	295PY10801STRL	295PY10809STRL
12	3	6840	15-1/2	2 1/2	105	Polyurethane/Iron	295PH12501STRL	295PY12509STRL
12	3-1/2	12000	15-1/2	2 1/2	128	Ductile Iron	295FM12601STRL	295FM12609STRL
12	3-1/2	8000	15-1/2	2 1/2	94	Laminated Phenolic	295TL12601STRL	295TL12609STRL
12	3-1/2	8000	15-1/2	2 1/2	94	Phenolic	295TM12601STRL	295TM12609STRL
12	3-1/2	8220	15-1/2	2 1/2	108	Polyurethane/Iron	295PY12601STRL	295PY12609STRL
12	4	9600	15-1/2	2 1/2	114	Polyurethane/Iron	295PY12701STRL	295PY12709STRL
12	5	12000	15-1/2	2 1/2	141	Polyurethane/Iron		295PY12809STRL

295 KINGPIN • CAPACITY TO 17000

DUAL WHEEL CASTERS

298

Aviation Ground Equipment Casters

CAPACITY TO 20000

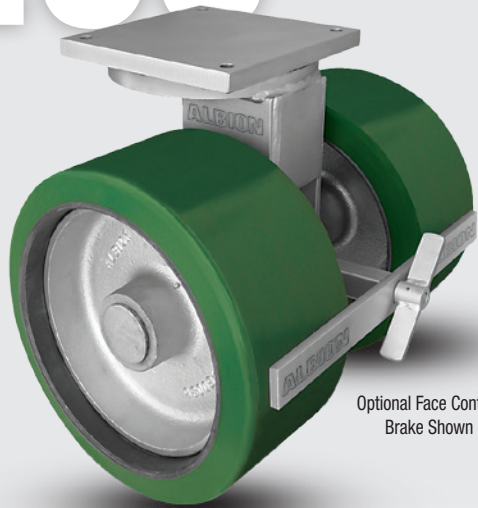

Optional Face Contact Brake Shown

Designed to meet the varied needs of the aviation ground support equipment industry, the 298 series sets the standards. Constructed with an oscillating, compensating wheel axle and cushion suspension leveling, these casters can stand up to even the most rigorous conditions. All optional features can be installed at the factory without an increase to order lead time. A spring assembly can be retrofitted at a later date; please consult factory. The swivel lock and face contact brake are field installable.

MOUNTING OPTION

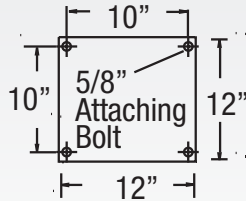

TYPICAL APPLICATIONS

- Aviation work stands
- Hangar doors
- Fuel cell transport

SWIVEL CROSS SECTION

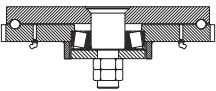

Premium Quality



Environmentally Friendly



Towing^

FEATURES

- **Top Plate and Yoke Base:** 1" thick 1045 AISI heat treated steel plate for superior strength
- **Swivel Raceways:** 11" diameter precision machined load raceway with 5/8" steel and tapered roller thrust bearing for easy swiveling
- **King Bolt:** 2" diameter bolt and nut heat treated for added strength
- **Legs:** 1/2" thick steel plate welded to form a box section column for maximum load capacity
- **Lubrication:** Zerk fittings in swivel section and wheel hub for ease of lubrication
- **Axle:** 2/1/2" oscillating axle precision machined at each end to accommodate 2" tapered bearings in wheel
- Alternate or custom caster configurations available

RIG OPTIONS

- **No Options** specify 001
- **Swivel lock** specify 002
- **Face contact brake** specify 003
- **Spring assembly** specify 004
- **Swivel lock and face contact brake** specify 005
- **Swivel lock and spring assembly** specify 006
- **Face contact brake and spring assembly** specify 007
- **Swivel lock, face contact brake and spring assembly** specify 008

BEARING OPTIONS



Tapered Roller (09)

WHEN FAILURE IS NOT AN OPTION...

The preferred caster for the aviation and group support industry – able to handle your most abusive application!

	Wheel Diameter (Inches)	Tread Width (Inches)	Capacity (Lbs) (Rated for normal operation)	Overall Height (Inches)	Swivel Lead (Inches)	Approx. Wt. (LBS)	Caster Number
Press-on Rubber (09 Tapered Roller Bearing)	12	4 1/2	4200	19	3 1/8	280	2980A12709S
	16 1/4	6	7800	21 5/16	3 1/8	320	2980A16909S
	18	9	13000	22	3 1/8	460	2980A18909S



	Wheel Diameter (Inches)	Tread Width (Inches)	Capacity (Lbs) (Rated for normal operation)	Overall Height (Inches)	Swivel Lead (Inches)	Approx. Wt. (LBS)	Caster Number
Press-on Polyurethane (09 Tapered Roller Bearing)	12	4 1/2	6600	19	3 1/8	300	2980G12709S
	16 1/4	6	12000	21 5/16	3 1/8	340	2980G16909S
	18	9	20000	22	3 1/8	480	2980G18909S

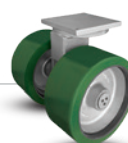

PNEUMATIC CASTERS

CAPACITY RANGE 200-7260 LBS



272 Series
Pneumatic Caster

Common Applications:

- Indoor/Outdoor Carts
- Delicate Cargo Carts
- Outdoor Platforms & Stages
- Dollies
- Hospitality Carts
- Nursery Carts

Excellent for

- Uneven or Rough Surfaces
- Shock Absorption
- Floor and Cargo Protection



16/72 Series
Capacity to 540 114



94/95 Series
Capacity up to 3630..... 116



16/72/90 Series
Capacity to 1170 115



272-295 Dual Cantilever Series
Capacity up to 7260..... 117

Let Freedom Roll!

When it was time to move the Liberty Bell ... only one caster company got the call!

ALBION®

PNEUMATIC CASTERS

16 72

Semi-Pneumatic Casters CAPACITY TO 540

Made in the USA



Premium Quality



Environmentally Friendly

FEATURES

- **Steel Rigs:** 16 Series rigs now **Made in the USA** for added reliability
- **Swivel Casters:** Double ball bearing raceway
- **Shock Absorbing:** Extra Heavy Duty Cushion wheel protects equipment
- **No inflation problems** as these wheels are not pressurized; they are a solid center tire
- **Pressure Lubrication:** 6" diameter wheels must be lubricated thru hollow axle, as pressure fitting cannot be inserted in wheel hub

RIG OPTIONS

- **Swivel lock** specify **L**
- **Face contact brake** specify **F**
- **Foot activated swivel lock** specify **SL160001** (16 Series Model)
- **Sealed swivel** specify **NS**

BEARING OPTIONS



Straight Roller (01)

Industrial Ball (27)

+ For swivel models add "S", for rigid model add "R" to end of base caster number.

These casters are recommended for light or medium duty dollies, bottlers trucks, hand trucks or other manually operated units and are suitable for extra heavy service. Semi-pneumatics are high profile, solid center cushion rubber tires mounted on stamped centers with lug base rims.

16

Wheel Diameter (Inches)	Tread Width/Type (Inches)	Capacity (Lbs) (Rate for manual operation)	Overall Height (Inches)	Swivel Lead (Inches)	Approx. Wt. (Lbs)	Base Caster Number+ Ball Bearing (27)	Base Caster Number+ Roller Bearing (01)
16 Series Semi-Pneumatic							
6	2.00EHS	200	7 ³ / ₈	1 ³ / ₄	6 ¹ / ₄	16SN06227	16SN06201
8	2.50EHS	350	10	1-3/4	10 ³ / ₄	16SN08427	16SN08401

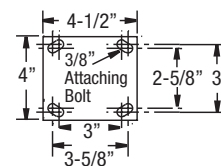

72

Wheel Diameter (Inches)	Tread Width/Type (Inches)	Capacity (Lbs) (Rate for manual operation)	Overall Height (Inches)	Swivel Lead (Inches)	Approx. Wt. (Lbs)	Base Caster Number+ Ball Bearing (27)	Base Caster Number+ Roller Bearing (01)
72 Series Semi-Pneumatic							
10	2.75EHS	350	11 ¹ / ₂	3 ¹ / ₂	17	72SN10427	72SN10401
12	3.00EHS	540	14 ¹ / ₂	3 ¹ / ₂	22	72SN12527	72SN12501

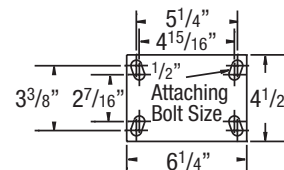

16 72 90

Pneumatic Casters

CAPACITY TO 1170



Premium Quality



Environmentally Friendly

FEATURES

- **Steel Rigs:** 16 Series rigs now **Made in the USA** for added reliability
- **Swivel Casters:** Double ball bearing raceway
- **Shock Absorbing:** Cushion wheel protects equipment
- **Bearings:** Ball or roller bearings

RIG OPTIONS

- **Swivel lock** specify **L**
- **Foot activated swivel lock** specify **SL160002** (16 Series Models)
- **Face contact brake** specify **F**
- **Sealed swivel** specify **NS**
- Foam fill available, consult factory
- Precision bearings available, consult factory
- For towed applications tapered bearings are recommended

BEARING OPTIONS



Straight Roller (01)

Industrial Ball (27)

+ For swivel models add "S", for rigid model add "R" to end of base caster number.

Pneumatic casters are recommended for the greatest possible protection to both load and floor, or for off-road application. If you transport fragile materials or parts, or if you move delicate instruments over rough floors, you should consider this product offering. Full pneumatics cushion the load on air as does automobile or truck wheels.

16

Wheel Diameter (Inches)	Tread Width/Type (Inches)	Capacity (Lbs) (Based for manual operation)	Overall Height (Inches)	Swivel Lead (Inches)	Approx. Wt. (Lbs)	Base Caster Number+ Ball Bearing (27)	Base Caster Number+ Roller Bearing (01)
16 Series Pneumatic							
8	2.00/4	210	9 1/2	1 3/4		16SF08227	
8	2.50/4	220	10 1/8	1 3/4	7	16SF08427	16SF08401
8	2.80/4	295	11	2 5/8	9 1/2	16SF08527	16SF08501
10	4.10/4	350	13	3 1/4	11	16SF10627	16SF10601
12	4.10/4	445	15 1/2	3 1/2	14 1/4	16SF12727	16SF12701

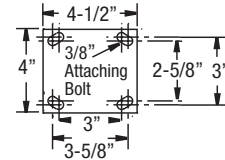

72

Wheel Diameter (Inches)	Tread Width/Type (Inches)	Capacity (Lbs) (Based for manual operation)	Overall Height (Inches)	Swivel Lead (Inches)	Approx. Wt. (Lbs)	Base Caster Number+ Ball Bearing (27)	Base Caster Number+ Roller Bearing (01)
72 Series Pneumatic							
8	2.00/4	210	11	2 5/8		72SF08227	
8	2.80/4	295	11	2 5/8	12 3/4	72SF08527	72SF08501
10	4.10/4	350	13	3 1/4	14 1/4	72SF10627	72SF10601
12	4.10/6	445	15 1/2	3 1/2	17 1/2	72SF12727	72SF12701

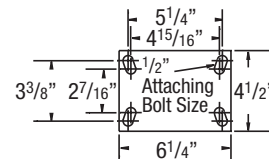

90

Wheel Diameter (Inches)	Tread Width/Type (Inches)	Capacity (Lbs) (Based for manual operation)	Overall Height (Inches)	Swivel Lead (Inches)	Approx. Wt. (Lbs)	Base Caster Number+ Ball Bearing (27)	Base Caster Number+ Roller Bearing (01)
90 Series Pneumatic							
14	5.30/6	785	17 3/4	4	29 1/4	90SF14827	90SF14801
16	4.80/8	1000	19 1/8	4 1/2	35 1/2		90SF16801
18	5.70/8	1170	21 1/4	5	41		90SF18901

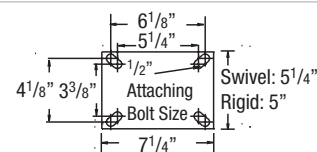

16/72/90 SERIES • CAPACITY TO 1170

PNEUMATIC CASTERS

94 95

Pneumatic Casters CAPACITY TO 3630

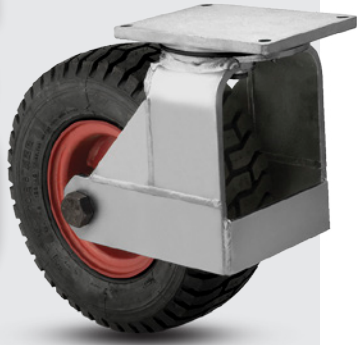

FEATURES

- **Swivel Casters:** Hardened double ball bearing raceway with 1-1/4" tapered roller thrust bearing
- **Shock Absorbing:** Cushion wheel protects equipment
- **Pressure Lubrication** to all bearings

BEARING OPTIONS



Tapered Roller (09)



Premium Quality



Environmentally Friendly

RIG OPTIONS

- **Swivel lock** specify L
- **Face contact brake** specify F
- **Sealed swivel** specify NS
- Foam fill available, consult factory

+ For swivel models add "S", for rigid model add "R" to end of base caster number.

94

Wheel Diameter (Inches)	Tread Width/Type (Inches)	Capacity (Lbs) (Roller for manual operation)	Overall Height (Inches)	Swivel Lead (Inches)	Approx. Wt. (Lbs)	Base Caster Number+ Tapered Roller Bearing (09)
94 Series Semi-Pneumatic						
16	4.80/8	1300	19 1/8	4	44 1/4	94SF16809SBBL
18	5.70/8	1590	21 1/2	4 1/2	54 3/4	94SF18909SBBL

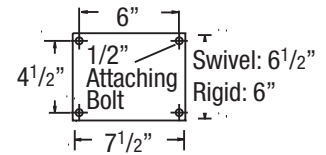

95

Wheel Diameter (Inches)	Tread Width/Type (Inches)	Capacity (Lbs) (Roller for manual operation)	Overall Height (Inches)	Swivel Lead (Inches)	Approx. Wt. (Lbs)	Base Caster Number+ Tapered Roller Bearing (09)
95 Series Semi-Pneumatic						
21	6.90/9	2420	24 1/4	5	84 1/4	95SF21909SBBL
23	6.50/10	2775	26 1/4	5	87 1/4	95SF23909SBBL
25	7.50/10	3630	28 3/4	5	90 1/2	95SF25909SBBL

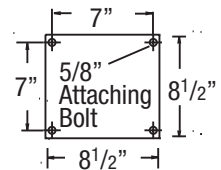

These casters and wheels are deluxe models. Use them for very heavy duty service. They will handle any job that is practical to mount on pneumatics. The tires are mounted on wide base rims. This permits more air volume, more load capacity, stability and cushioning. Wheel bearings are tapered with dust seals. **Note:** model ordered may look different than photo above.

CUSTOM FABRICATION

This is not a one-size-fits-all business. In fact, many of our orders require custom fabrication.

If you can't find the right caster for your special application, put the Albion engineering team to work. We will create the perfect solution for your moving problem.



See pages 16-17

272 290 294 295

Cantilever-Style Dual Wheel Pneumatic Casters CAPACITY TO 7260



Premium Quality



Environmentally Friendly

FEATURES

- **Swivel Casters:** Double ball bearing raceway. BBL models Hardened double ball bearing raceway with 1-1/4" tapered roller thrust bearing
- **Shock Absorbing:** Cushion wheel protects equipment
- **Pressure Lubrication** to all bearings

RIG OPTIONS

- **Swivel lock** specify L
- **Face contact brake** specify F
- **Sealed swivel** specify NS
- **Foam fill** available, consult factory

BEARING OPTIONS



Straight Roller (01)

Tapered Roller (09)

+ For swivel models add "S", for rigid model add "R" to end of base caster number.

Wheel Diameter (Inches)	Tread Width/Type (Inches)	Capacity (Lbs) (Rated for manual operation)	Overall Height (Inches)	Swivel Lead (Inches)	Approx. Wt. (Lbs)	Base Caster Number+ Roller Bearing (01), Tapered Roller Bearing (09)
8	2.80/4	590	11	25/8		272SF08501
10	4.10/4	700	13	3 1/4	2 13/4	272SF10601

272



Dual wheel models are recommended for the greatest possible protection to both loads and floors with increased capacity. If you transport fragile materials or parts, or if you move delicate instruments over rough floors, you should consider this product offering.

290

Wheel Diameter (Inches)	Tread Width/Type (Inches)	Capacity (Lbs) (Rated for manual operation)	Overall Height (Inches)	Swivel Lead (Inches)	Approx. Wt. (Lbs)	Base Caster Number+ Roller Bearing (01), Tapered Roller Bearing (09)
12	4.10/6	890	15 1/2	3 1/2	35	290SF12701
14	5.30/6	1570	17 3/4	4	41	290SF14801
16	4.80/9	2000	19 1/8	4 1/2	53 1/4	290SF16801
18	5.70/8	2340	21 1/4	5	59 3/4	290SF18901

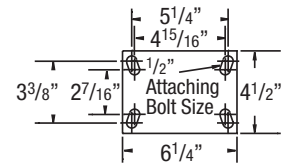

294

Wheel Diameter (Inches)	Tread Width/Type (Inches)	Capacity (Lbs) (Rated for manual operation)	Overall Height (Inches)	Swivel Lead (Inches)	Approx. Wt. (Lbs)	Base Caster Number+ Roller Bearing (01), Tapered Roller Bearing (09)
16	4.80/8	2600	19 1/8	4	71	294SF16809SBBL
18	5.70/8	3180	21 1/2	4 1/2	81 3/4	294SF18909SBBL

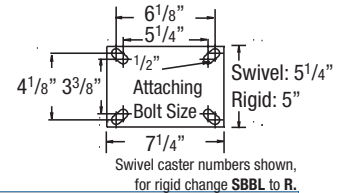

295

Wheel Diameter (Inches)	Tread Width/Type (Inches)	Capacity (Lbs) (Rated for manual operation)	Overall Height (Inches)	Swivel Lead (Inches)	Approx. Wt. (Lbs)	Base Caster Number+ Roller Bearing (01), Tapered Roller Bearing (09)
21	6.90/9	4840	24 1/4	5	129 3/4	295SF21909SBBL
23	6.50/10	5550	26 1/4	5	134 1/2	295SF23909SBBL
25	7.50/10	7260	28 3/4	5	139	295SF25909SBBL

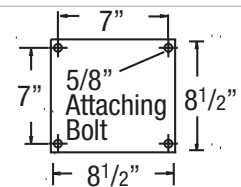
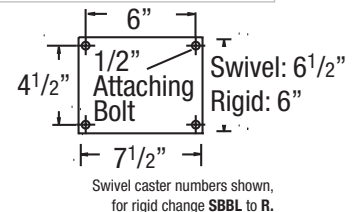

272/290/294/295 SERIES • CAPACITY TO 7260

PNEUMATIC CASTERS

AIR CARGO AND AVIATION

CAPACITY RANGE 375-450 LBS



Cargo Conveyor Casters

Common Applications:

- Aviation Industry
- Cargo Industry
- Automotive Industry
- Conveyor Systems



Albion 03 Air Cargo/Conveyor
Capacity to 450 119



Faultless Air Cargo/Conveyor
Capacity to 375 120



Jarvis Air Cargo/Conveyor
Capacity to 400 121

Before you fly, you need to roll! View Our Popular Aviation Caster Series:

LASER CUT INTEGRATED BRAKES



New PLB brakes are now available for aviation industry casters (pages 48-51).

LONGER LASTING KINGPINLESS CASTERS



If you need casters that will be impacted or shock-loaded ... or casters more suited for power-towed applications, see the Heavy Duty Kingpinless Section (pages 41-58).

DUAL WHEELS FOR ULTIMATE STABILITY



Looking to gain higher load ratings with low overall heights, better product stability and floor protection, or softer wheel options while maintaining high load ratings? View all of our dual wheel options (pages 100-112).

SPRING LOADED CASTERS



If you need casters that offer spring loaded protection from damaging shock, unwanted vibration and reduced noise levels, see the Spring Loaded Section (pages 87-99).

03

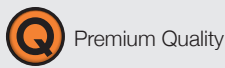

Air Cargo/Conveyor Casters

CAPACITY TO 450



Priority Economy

Priority with Optional Toe Guard

Three quality levels to meet all of your air cargo conveyor needs.

Priority Premier™ is built to exceptional manufacturing standards. **Priority** features precision bearings in wheel and raceway. **Priority Economy** casters provide dependability on a budget.

MOUNTING OPTIONS

Priority Premier™ Models

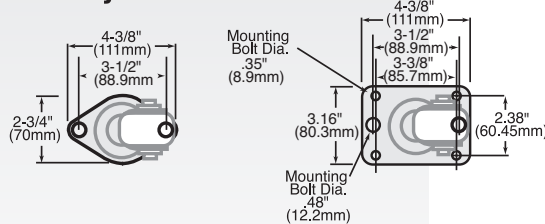

Priority and Priority Economy Models

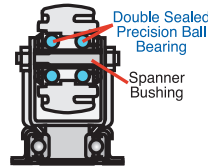
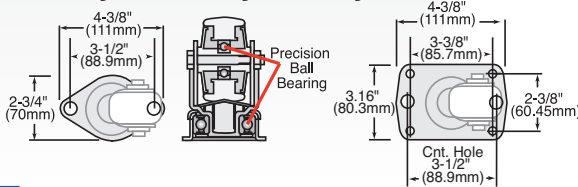

TOE GUARD OPTIONS



106mm Specify T0-106 120mm Specify T0-120 145mm Specify T0-145

TYPICAL APPLICATIONS

- Cargo Conveyor Equipment

Wheel Diameter (Inches)	Tread Width (Inches)	Capacity (Lbs) (Rated for manual operation)	Overall Height (Inches)	Approx. Wt. (Lbs)	Caster Number
-------------------------	----------------------	--	-------------------------	-------------------	---------------

Priority Premier™ Rectangular Plate Yellow Dichromate Finish					
2 1/4 (58mm)	1 3/4 (34mm)	450	3 3/4 (96mm)	1 3/4	03XN02028S004C
Double sealed precision ball bearing.					

Priority Premier™ Rectangular Plate Yellow Dichromate Metal Toe Guard					
2 1/4 (58mm)	1 3/4 (34mm)	450	3 3/4 (96mm)	1 3/4	03XN02028S001C
Double sealed precision ball bearing.					

FEATURES

Priority Premier™

- Sealed precision ball bearing in swivel section and wheel
- 1/8" formed steel construction
- Additional O-ring seal in swivel section prevents contamination
- Shock resistant premium nylon wheel
- Zinc plated finish on diamond plate models, yellow dichromate finish on rectangular plate models
- Optional Integral toe guard on 2 1/4" models
- Metal Thread Guards

Priority

- Sealed precision ball bearing in swivel section and wheel
- 1/8" formed steel construction
- White nylon thread guards
- Shock resistant wheels
- Zinc plated finish

Priority Economy

- Semi-precision unsealed ball bearings
- 1/8" formed steel construction
- Black polypropylene thread guards
- Shock resistant wheels
- Zinc plated finish

Wheel Diameter (Inches)	Tread Width (Inches)	Capacity (Lbs) (Rated for manual operation)	Overall Height (Inches)	Approx. Wt. (Lbs)	Caster Number
-------------------------	----------------------	--	-------------------------	-------------------	---------------

Priority Diamond Plate Zinc Finish					
2 1/4 (58mm)	1 11/32 (34mm)	450	3 3/4 (96mm)	1 3/4	03PR02028S
2 3/4 (70mm)	1 11/32 (34mm)	450	4 (102mm)	1 3/4	03PR03028S

Priority Rectangular Plate Zinc Finish					
2 1/4 (58mm)	1 11/32 (34mm)	450	3 3/4 (96mm)	1 3/4	03PR02028S004
2 3/4 (70mm)	1 11/32 (34mm)	450	4 (102mm)	1 3/4	03PR03028S004

Priority Economy Diamond Plate Zinc Finish					
2 1/4 (58mm)	1 11/32 (34mm)	450	3 3/4 (96mm)	1 3/4	03PE02028S
2 3/4 (70mm)	1 11/32 (34mm)	450	4 (102mm)	1 3/4	03PE03028S

Priority Economy Rectangular Plate Zinc Finish					
2 1/4 (58mm)	1 11/32 (34mm)	450	3 3/4 (96mm)	1 3/4	03PE02028S004
2 3/4 (70mm)	1 11/32 (34mm)	450	4 (102mm)	1 3/4	03PE03028S004

Faultless Precision, Heavy Duty Air Cargo/Conveyor Caster



CAPACITY TO 375



Designed for inverted applications, these Faultless conveyor casters are designed for easy installation and replacement in the field. Special dust-and-grease cap and special all-temperature lubricant are standard along with precision bearing swivel and needle bearing wheels. Corrosive-resistant zinc dichromate finish is standard.

MOUNTING OPTIONS

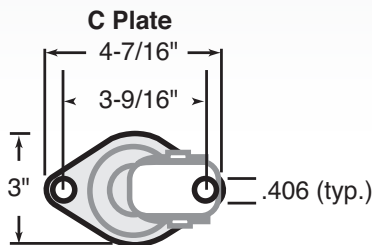
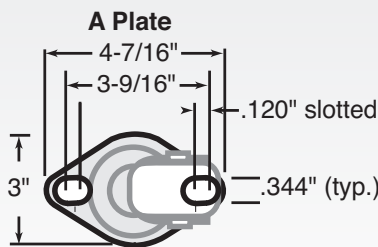

TYPICAL APPLICATIONS

- Cargo Conveyor Equipment

FEATURES

- **Raceways:** Fully sealed raceways for low maintenance and protection of the swivel head in outdoor environments
- **Swivel Bearings:** Precision bearing swivel
- **Wheel Bearings:** Need bearings or ball bearings; thread guards standard for longer life
- **Finish:** Corrosion-resistant zinc dichromate or powder coated finishes
- **Suggested Temperature Range:** 20°F to +180°F
- **Special Top Plates Available:** For specific installation requirements, consult factory

	Wheel Diameter (Inches)	Tread Width (Inches)	Capacity (Lbs) (rated for manual operation)	Overall Height (Inches)	Swivel Radius (Inches)	Caster Number
Polyflex Brown (Needle Bearing) with A Plate	2-3/4	13/8	375	41/32	23/8	27015



Polyflex Brown (Needle Bearing) with C Plate	3	15/6	270	325/32	25/8	25675
	3	15/6	300	41/32	215/32	25696



Polyflex Grey with Toe Guard (Needle Bearing) with A Plate	2-3/4	13/8	375	41/32	23/16	27016
---	-------	------	-----	-------	-------	--------------



Polyflex Brown with Toe Guard (Needle Bearing) with A Plate	2-3/4	13/8	375	41/32	213/16	26381
--	-------	------	-----	-------	--------	--------------



Jarvis Air Cargo/Conveyor Casters

CAPACITY TO 400



This air cargo caster is manufactured to withstand the day after day abuse of the air cargo industry. Designed for use on cargo sorting decks and trailers, the premium grade nylon wheel is designed to withstand heavy shock impacts and the dual ball bearings provide smooth rolling under the most abusive environments.

MOUNTING OPTIONS

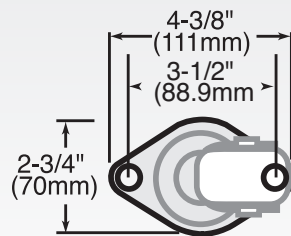

TYPICAL APPLICATIONS

- Cargo Conveyor Equipment

FEATURES

- Dual ball bearing for increased rollability and weight capacity
- 1/8" formed steel construction
- Quiet operation
- Corrosion resistant and durable attractive yellow dichromate finish
- Metal thread guards to prevent debris from entering bearing
- Full swivel seals for longer life

Wheel Diameter (Inches)	Tread Width (Inches)	Capacity (Lbs) (Rated for manual operation)	Overall Height (Inches)	Swivel Lead (Inches)	Approx. Wt. (Lbs)	Caster Number
3	1 1/4	400	4	15/32	1 3/4	FG3NYLONAIR



SPECIALTY CASTERS

CAPACITY RANGE 210-1500 LBS



DC Dolly Casters

An Economical and Floor Protective Dolly Solution

Common Applications:

- Business Machines
- Server Racks
- Cabinets/Cases
- Vending Machines
- Industrial Carts
- Material Handling Equipment
- Economical Carts
- Swing or Sliding Gates



20/21 Series Business Machine
Capacity to 1200 123



E-Line
Medium Heavy Duty Economical
Capacity to 1250 126-128



DC Dolly Casters
Capacity to 350 124



Gate Casters
Capacity to 210 129



Bassick Honcho AS Series
Capacity to 1250 125

Custom Fabrication (see pages 16-17)

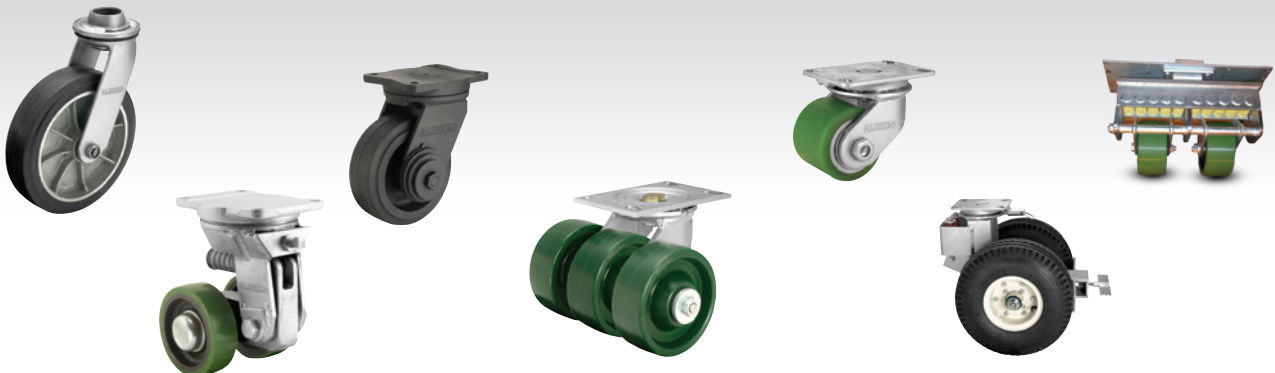

20 21

Business Machine Low Profile Casters CAPACITY TO 1200



MOUNTING OPTIONS

Standard Model Plate

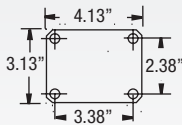

Attaching Bolt
20 Series: 5/16"
21 Series: 3/8"

O2 Series Model Plate

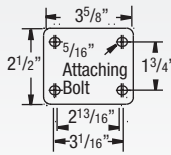

Specify O2 at end of caster part no.

TYPICAL APPLICATIONS

- Dollies
- Server shelves
- Cabinets/Cases
- Soda machines
- Vending Equipment
- Business machine equipment



Premium Quality



Environmentally Friendly

FEATURES

- **Construction:** 20 Series: Heat treated stamped steel. 21 Series: welded steel
- **Finish:** Black finish for corrosion prevention and sleek appearance

RIG OPTIONS

- **Zinc finish option** specify **ZN**



- **4.03" overall height option**, consult factory
- **Optional mounting hole diameters** available, consult factory

BEARING OPTIONS



Straight Roller (O1) Drawn Cup Roller (O2) Precision Ball (28)

BRAKE OPTIONS

Thumbscrew specify **B**



- High Capacity
- Low Height
- Stamped or Welded Construction

+ For swivel models add "S", for rigid model add "R" to end of base caster number.

Wheel Diameter (Inches)	Tread Width (Inches)	Capacity (Lbs) (Rated for manual operation)	Overall Height (Inches)	Swivel Lead (Inches)	Approx. Wk. (Lbs)	Base Caster Number+
-------------------------	----------------------	---	-------------------------	----------------------	-------------------	---------------------

20 Series Business Machine

	Polypropylene (Roller Bearing)	3	1.81	500	3.97	1.08	3	20PB03201
	Nylon Glass Filled (Roller Bearing)	3	1.81	700	3.97	1.08	3	20NG03201
	Phenolic (Roller Bearing)	3	1.81	700	3.97	1.08	3	20TM03201
	Solid Polyurethane (Precision Ball Bearing)	3	1.81	700	3.97	1.08	3	20XP03228

Axle diameter is 7/16"

+ For swivel models add "S", for rigid model add "R" to end of base caster number.

Wheel Diameter (Inches)	Tread Width (Inches)	Capacity (Lbs) (Rated for manual operation)	Overall Height (Inches)	Swivel Lead (Inches)	Approx. Wk. (Lbs)	Base Caster Number+
-------------------------	----------------------	---	-------------------------	----------------------	-------------------	---------------------

21 Series Business Machine

	Nylon Glass Filled (Roller Bearing)	3	1.81	1200	4.16	.81	3	21NG03201
	Phenolic (Roller Bearing)	3	1.81	1000	4.16	.81	3	21TM03201
	Solid Polyurethane (Sealed Precision Ball Bearing)	3	1.81	1200	4.16	.81	3	21XP03228

Axle diameter is 1/2"

Note: Lead times may vary on certain items, consult factory.

DC

DC Dolly Casters

CAPACITY TO 350



FEATURES

- **Swivel Section:** Double ball raceway for standard top plate (Single ball raceway for optional S01 top plate)
- **Finish:** Zinc plated finish
- **Thread Guards:** Interlocking thread guards standard on XS models, keeping out entangling debris for longer life
- **Construction:** Riveted construction
- Alternate or custom caster configurations available

RIG OPTIONS

NSF: Consult factory

BRAKE OPTION

Face Contact specify F



BEARING OPTIONS

Annular Ball (31)
Plain (41)

An ideal solution for dolly applications; the DC Dolly lineup is both economical and durable. All wheels are non-marking, and the XS wheels feature interlocking thread guards to protect them from entangling debris.

TYPICAL APPLICATIONS

- Dolly carts
- Display carts

SWIVEL CROSS SECTION

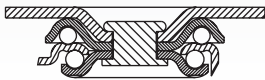

MOUNTING OPTIONS Standard Plate

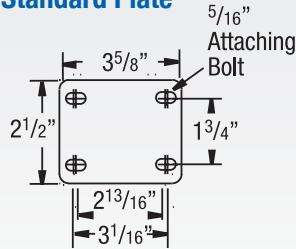

Special Order Plates S01 Top Plate for parts ending in S01

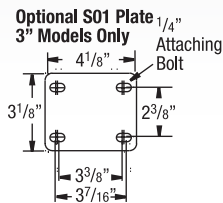

- Economical
- Non marking
- Thread guards protect axle from entangling debris

+ For swivel models add "S", for rigid model add "R" to end of base caster number.

	Wheel Diameter (Inches)	Tread Width (Inches)	Capacity (Lbs) (Based for manual operation)	Overall Height (Inches)	Swivel Lead (Inches)	Approx. Wt. (Lbs)	Base Caster Number+
TPR Rubber (31 Annular Ball Bearing)							
XS	3	1 1/4	275	3.8	1 1/4	.5	DCXS03031S01
	3	1 1/4	275	4 1/4	1 11/16	.5	DCXS03031
	3 1/2	1 1/4	300	4 3/4	1 11/16	.5	DCXS03X31
	4	1 1/4	325	5 1/4	1 11/16	.5	DCXS04031
	5	1 1/4	350	6 1/4	1 11/16	.5	DCXS05031

Non-marking TPR wheel (75 Shore A)

Polyurethane on Polypropylene (41 Plain Bearing)

	Wheel Diameter (Inches)	Tread Width (Inches)	Capacity (Lbs) (Based for manual operation)	Overall Height (Inches)	Swivel Lead (Inches)	Approx. Wt. (Lbs)	Base Caster Number+
XA	3	1 1/4	275	3.8	1 1/4	.5	DCXA03041S01
	3	1 1/4	275	4 1/4	1 11/16	.5	DCXA03041
	3 1/2	1 1/4	300	4 3/4	1 11/16	.5	DCXA03X41
	4	1 1/4	325	5 1/4	1 11/16	.5	DCXA04041
	5	1 1/4	350	6 1/4	1 11/16	.5	DCXA05041

+ For swivel models add "S", for rigid model add "R" to end of base caster number.

	Wheel Diameter (Inches)	Tread Width (Inches)	Capacity (Lbs) (Based for manual operation)	Overall Height (Inches)	Swivel Lead (Inches)	Approx. Wt. (Lbs)	Base Caster Number+
Polypropylene (41 Plain Bearing)							
PB	3	1 1/4	275	3.8	1 1/4	.5	DCPB03041S01
	3	1 1/4	275	4 1/4	1 11/16	.5	DCPB03041
	3 1/2	1 1/4	300	4 3/4	1 11/16	.5	DCPB03X41
	4	1 1/4	325	5 1/4	1 11/16	.5	DCPB04041
	5	1 1/4	350	6 1/4	1 11/16	.5	DCPB05041

AS Bassick Honcho



Legendary Bassick Honcho casters feature sealed upper and lower raceways for additional protection from the elements. The caster legs are embossed, formed legs for added strength. Yellow dichromate finish for added corrosion resistance.

TYPICAL APPLICATIONS

- Platform trucks
- Warehouse trucks
- Material handling containers
- Floor trucks

MOUNTING OPTION

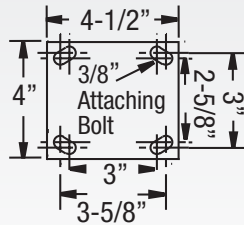

For rigid models change "CAS" to "CAR"

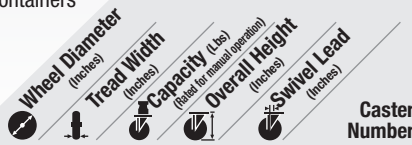

Soft Rubber (51 Roller Bearing)						
SFR	5	2	450	6 1/2	3 11/16	CAS50156YZ-SFR51(KK)
	6	2	475	7 1/2	4 3/8	CAS60156YZ-SFR51(KK)
	8	2	600	9 1/2	5 13/16	CAS80156YZ-SFR51(KK)

Hard Rubber (51 Roller Bearing)						
HDR	5	2	600	6 1/2	3 11/16	CAS50156YZ-HDR51(KK)
	6	2	650	7 1/2	4 3/8	CAS60156YZ-HDR51(KK)
	8	2	750	9 1/2	5 13/16	CAS80156YZ-HDR51(KK)

Polyolefin (51 Roller Bearing)						
POD	4	2	600	5 1/2	3	CAS40156YZ-POD51(KK)
	5	2	650	6 1/2	3 11/16	CAS50156YZ-POD51(KK)
	6	2	700	7 1/2	4 3/8	CAS60156YZ-POD51(KK)
	8	2	900	9 1/2	5 13/16	CAS80156YZ-POD51(KK)

Phenolic (51 Roller Bearing)						
PHN	4	2	800	5 1/2	3	CAS40156YZ-PHN51(KK)
	5	2	1250	6 1/2	3 11/16	CAS50156YZ-PHN51(KK)
	6	2	1200	7 1/2	4 3/8	CAS60156YZ-PHN51(KK)
	8	2	1250	9 1/2	5 13/16	CAS60156YZ-PHN51(KK)

FEATURES

- **Upper/Lower Raceway Rubber seals:** Rubber swivel raceway seals help protect casters
- **Finish:** Attractive yellow dichromate finish for added corrosion resistance
- **Top Plate & Yoke Base:** Cold formed
- **Swivel Section:** Full double ball heat treated raceways. Drawn and formed ballcup
- **Fork Legs:** Embossed, formed legs for added strength
- Alternate or custom caster configurations available

BRAKE OPTIONS

Add brake code to end of caster number

Total Lock
specify -TLB



Side Lock
specify -SB

Swivel Lock
specify -SL



BEARING OPTIONS

Straight Roller (51) Sealed Roller (81)



For rigid models change "CAS" to "CAR"

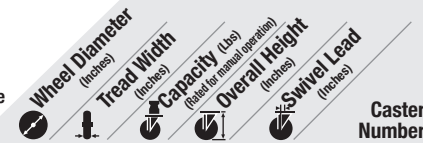

K Solid Urethane (81 Sealed Roller Bearing)						
KPU	4	2	700	5 1/2	3	CAS40156YZ-KPU81(KK)
	5	2	1000	6 1/2	3 11/16	CAS50156YZ-KPU81(KK)
	6	2	1200	7 1/2	4 3/8	CAS60156YZ-KPU81(KK)
	8	2	1250	9 1/2	5 13/16	CAS80156YZ-KPU81(KK)

RT Reinforced Thermoplastic (51 Roller Bearing)						
FRT	4	2	700	5 1/2	3	CAS40156YZ-FRT51(KK)
	5	2	1000	6 1/2	3 11/16	CAS50156YZ-FRT51(KK)
	6	2	1200	7 1/2	4 3/8	CAS60156YZ-FRT51(KK)
	8	2	1250	9 1/2	5 13/16	CAS80156YZ-FRT51(KK)

Eagle Urethane (51 Roller Bearing)						
EAG	4	2	600	5 1/2	3	CAS40156YZ-EAG51(BK)
	5	2	1100	6 1/2	3 11/16	CAS50156YZ-EAG51(BK)
	6	2	1100	7 1/2	4 3/8	CAS60156YZ-EAG51(BK)
	8	2	1250	9 1/2	5 13/16	CAS80156YZ-EAG51(BK)

Urethane on Aluminum (81 Sealed Roller Bearing)						
UOA	5	2	1250	6 1/2	3 11/16	CAS50156YZ-UOA81(BG)
	6	2	1250	7 1/2	4 3/8	CAS60156YZ-UOA81(BG)
	8	2	1250	9 1/2	5 13/16	CAS80156YZ-UOA81(BG)

Steel (51 Roller Bearing)						
STL	4	2	1200	5 1/2	3	CAS40156YZ-STL51(GG)
	5	2	1250	6 1/2	3 11/16	CAS50156YZ-STL51(GG)
	6	2	1250	7 1/2	4 3/8	CAS60156YZ-STL51(GG)
	8	2	1250	9 1/2	5 13/16	CAS80156YZ-STL51(GG)

E-Line **Economical Casters**

CAPACITY TO 1250



The E-line is an economical lineup of casters and wheels designed and mass-produced for a range of medium duty applications with load requirements ranging from 300 to 1,250 lbs. per caster. From shop carts and containers, to platform and lumber carts – the E-Line is your most competitive and in-stock 2" wide solution.

TYPICAL APPLICATIONS

- Shop Carts
- Retail Platform and Lumber Carts
- Warehouse Carts and Trucks
- Waste Containers
- Dollies
- Toolboxes

SWIVEL CROSS SECTION

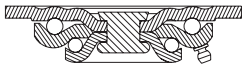

MOUNTING OPTION

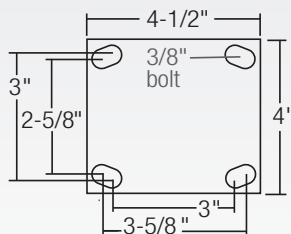

FEATURES

- **Top Plate & Yoke Base:** Cold formed from 1/4" steel plate. Yoke base is notched for factory or field-installable 4-position swivel lock
- **Swivel Section:** Double ball raceways for smooth swiveling action
- **Fork Legs:** 1/4" thick steel leg construction on swivel and rigid casters ... 3/16" construction on total lock casters
- **Kingpin:** 5/8" diameter permanent rivet kingpin
- **Axle:** 1/2" hollow axle with grease zerk and lock nut
- **Wheel seals:** Nylon seal retaining/thrust washers
- **RoHS:** RoHS compliant industrial zinc finish for corrosion resistance
- **Lubrication:** Zerk fitting in swivel section and in recessed head of hollow axle on straight roller and Delrin bearing wheels
- **NSF:** Select models (consult factory)
- **Thread Guards:** Select models have thread guard option (consult factory)

BEARING OPTIONS

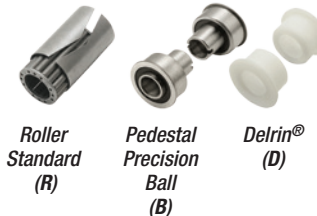

To change the standard roller bearing to an optional bearing in a caster, add **B** or **D** to the end of caster number.

Plastic retainer washers come standard on wheels with roller bearings; to order optional steel retainer washers add **SW** to the end of the part#. Example ES6X2CIRSW

RIG OPTIONS

- Sealed raceway option. Add **RS** after ES for free swivel models (example: ESRS6X2TPR). Seals are not available for total lock models.
- Integrated total lock brake, see brake options below. Maximum weight capacity of total lock brake models is 900lbs.

BRAKE OPTIONS

To order, add brake code below to end of model. Example: ES6X2MORWFB

Total Lock change ES to ET in charts on right.



Wheel Face All swivel models along with 6" and 8" rigid models specify **WFB**

Tread Brake swivel and rigid models specify **TBK**



Short Pedal -5" length cam swivel and rigid models. Roller bearing required specify **CAMS**

Long Pedal -7" length cam swivel and rigid models. Roller bearing required. Not available on 4" diameter models, specify **CAML**



Hand operated field installable swivel lock order **SWVLOCKX2** separately

E-Line Examples

ES6X2MOR



ES6X2TPDWFB



ES6X2TUMCAMS



ER6X2PDTBK



ES6X2MOPTBK



ET6X2TPR



ER6X2TPUCAML



ET6X2PKTP8



ES6X2PHNCAML



ES6X2CIR



+ Swivel models shown in chart, for rigid models change 1st two digits "ES" to "ER".

Wheel Diameter (Inches)	Tread Width (Inches)	Capacity (Lbs) (Based on manual operation)	Overall Height (Inches)	Swivel Lead (Inches)	Approx. Wt. (Lbs)	Caster Number+

Moldon Rubber (R Roller Bearing)

MOR	4	2	400	5 ⁵ / ₈	3 ³ / ₈	—	ES4X2MOR
	5	2	400	6 ¹ / ₂	4	—	ES5X2MOR
	6	2	550	7 ¹ / ₂	4 ³ / ₄	—	ES6X2MOR
	8	2	600	9 ¹ / ₂	6 ¹ / ₄	—	ES8X2MOR

To change the standard roller bearing to an optional bearing, add **B** (Precision Ball) to the end of the part #.

Thermo-Rubber (Donut) (R Roller Bearing)

TPD	4	2	300	5 ⁵ / ₈	3 ³ / ₈	—	ES4X2TPD
	5	2	350	6 ¹ / ₂	4	—	ES5X2TPD
	6	2	500	7 ¹ / ₂	4 ³ / ₄	—	ES6X2TPD
	8	2	600	9 ¹ / ₂	6 ¹ / ₄	—	ES8X2TPD

To change the standard roller bearing to an optional bearing, add **B** (Precision Ball) or **D** (Delrin) to the end of the part #.

PolyKat™ Thermo-Urethane (TP8 Precision Ball Bearing)

PKTP8	4	2	600	5 ⁵ / ₈	3 ³ / ₈	—	ES4X2PKTP8
	5	2	800	6 ¹ / ₂	4	—	ES4X2PKTP8
	6	2	1000	7 ¹ / ₂	4 ³ / ₄	—	ES4X2PKTP8
	8	2	1200	9 ¹ / ₂	6 ¹ / ₄	—	ES8X2PKTP8

Thermo-Urethane (Maroon/Grey) (R Roller Bearing)

TUM	4	2	500	5 ⁵ / ₈	3 ³ / ₈	—	ES4X2TUM
	5	2	600	6 ¹ / ₂	4	—	ES5X2TUM
	6	2	720	7 ¹ / ₂	4 ³ / ₄	—	ES6X2TUM
	8	2	800	9 ¹ / ₂	6 ¹ / ₄	—	ES8X2TUM

To change the standard roller bearing to an optional bearing, add **B** (Precision Ball) or **D** (Delrin) to the end of the part #.

Phenolic (R Roller Bearing)

PHN	4	2	800	5 ⁵ / ₈	3 ³ / ₈	—	ES4X2PHN
	5	2	1000	6 ¹ / ₂	4	—	ES5X2PHN
	6	2	1200	7 ¹ / ₂	4 ³ / ₄	—	ES6X2PHN
	8	2	1250	9 ¹ / ₂	6 ¹ / ₄	—	ES8X2PHN

To change the standard roller bearing to an optional bearing, add **B** (Precision Ball) or **D** (Delrin) to the end of the part #.

+ Swivel models shown in chart, for rigid models change 1st two digits "ES" to "ER".

Wheel Diameter (Inches)	Tread Width (Inches)	Capacity (Lbs) (Based on manual operation)	Overall Height (Inches)	Swivel Lead (Inches)	Approx. Wt. (Lbs)	Caster Number+

Thermo-Rubber (Flat) (R Roller Bearing)

TPR	4	2	300	5 ⁵ / ₈	3 ³ / ₈	—	ES4X2TPR
	5	2	350	6 ¹ / ₂	4	—	ES5X2TPR
	6	2	500	7 ¹ / ₂	4 ³ / ₄	—	ES6X2TPR
	8	2	600	9 ¹ / ₂	6 ¹ / ₄	—	ES8X2TPR

To change the standard roller bearing to an optional bearing, add **B** (Precision Ball) or **D** (Delrin) to the end of the part #.

Polyurethane HD (R Roller Bearing)

POD	4	2	500	5 ⁵ / ₈	3 ³ / ₈	—	ES4X2POD
	5	2	600	6 ¹ / ₂	4	—	ES5X2POD
	6	2	600	7 ¹ / ₂	4 ³ / ₄	—	ES6X2POD
	8	2	900	9 ¹ / ₂	6 ¹ / ₄	—	ES8X2POD

To change the standard roller bearing to an optional bearing, add **B** (Precision Ball) or **D** (Delrin) to the end of the part #.

Thermo-Urethane (Red/Black) (R Roller Bearing)

TPU	4	2	500	5 ⁵ / ₈	3 ³ / ₈	—	ES4X2TPU
	5	2	600	6 ¹ / ₂	4	—	ES5X2TPU
	6	2	720	7 ¹ / ₂	4 ³ / ₄	—	ES6X2TPU
	8	2	800	9 ¹ / ₂	6 ¹ / ₄	—	ES8X2TPU

To change the standard roller bearing to an optional bearing, add **B** (Precision Ball) or **D** (Delrin) to the end of the part #.

Mold-on Poly (R Roller Bearing)

MOP	4	2	800	5 ⁵ / ₈	3 ³ / ₈	—	ES4X2MOP
	5	2	1100	6 ¹ / ₂	4	—	ES5X2MOP
	6	2	1200	7 ¹ / ₂	4 ³ / ₄	—	ES6X2MOP
	8	2	1250	9 ¹ / ₂	6 ¹ / ₄	—	ES8X2MOP

To change the standard roller bearing to an optional bearing, add **B** (Precision Ball) to the end of the part #.

Cast Iron (R Roller Bearing)

CIR	4	2	800	5 ⁵ / ₈	3 ³ / ₈	—	ES4X2CIR
	5	2	1000	6 ¹ / ₂	4	—	ES5X2CIR
	6	2	1200	7 ¹ / ₂	4 ³ / ₄	—	ES6X2CIR
	8	2	1250	9 ¹ / ₂	6 ¹ / ₄	—	ES8X2CIR

To change the standard roller bearing to an optional bearing, add **B** (Precision Ball) to the end of the part #.

BRAKE SWIVEL RADIUS CHART

Wheel Diameter	Swivel Radius				
	Wheel Face Brake	Tread Lock Brake	Short Pedal Cam	Long Pedal Cam	Total Lock
4"	6-13/32"	3-5/8"	4-23/32"	N/A	5-7/16"
5"	7-1/32"	4"	5"	6"	5-13/16"
6"	7-21/32"	4-3/4"	5-1/2"	6-5/32"	6"
8"	9-1/16"	6-1/4"	6-1/4"	6-5/8"	6-3/8"

E-Line Components

Swivel and Rigid Rigs



Wheel Dia.	Tread Width	*Load Capacity (lbs)	Mount Height	Swivel Caster Part #	Rigid Caster Part #
4"	2"	1250	5-5/8"	RIG4X2ES	RIG4X2ER
5"	2"	1250	6-1/2"	RIG5X2ES	RIG5X2ER
6"	2"	1250	7-1/2"	RIG6X2ES	RIG6X2ER
8"	2"	1250	9-1/2"	RIG8X2ES	RIG8X2ER

Total Lock Rigs



Wheel Dia.	Tread Width	*Load Capacity (lbs)	Mount Height	Swivel Radius	Part #
4"	2"	900	5-5/8"	5-7/16"	RIG4X2EST
5"	2"	900	6-1/2"	5-13/16"	RIG5X2EST
6"	2"	900	7-1/2"	6"	RIG6X2EST
8"	2"	900	9-1/2"	6-3/8"	RIG8X2EST

*Some wheels have lower capacities. See pemcoasters.com/e/line for specifications.

Wheels

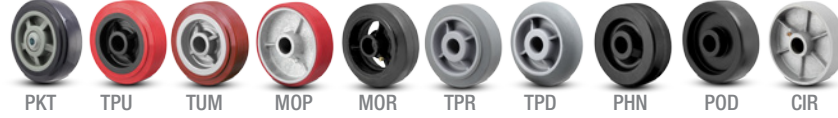

Wheel Dia.	Tread Width	Wheel Type	Load Capacity (lbs)	Standard Bore	Wheel Part # (Plain bore)
4"	2"	PolyKat™ Thermo-Urethane	600	1/2"	WH4X2PKTP8
		Thermo-Urethane (Red/Black)	500	1-3/16"	WH4X2TPU19
		Thermo-Urethane (Maroon/Grey)	500	1-3/16"	WH4X2TUM19
		Mold-on Poly	800	1-3/16"	WH4X2MOP19
		Mold-on Rubber	400	1-3/16"	WH4X2MOR19
		Thermo-Rubber (Flat)	300	1-3/16"	WH4X2TPR19
		Thermo-Rubber (Donut)	300	1-3/16"	WH4X2TPD19
		Phenolic	800	1-3/16"	WH4X2PHN19
		Polypropylene HD	500	1-3/16"	WH4X2POD19
5"	2"	Cast Iron	800	1-3/16"	WH4X2CIR19
		PolyKat™ Thermo-Urethane	800	1/2"	WH5X2PKTP8
		Thermo-Urethane (Red/Black)	600	1-3/16"	WH5X2TPU19
		Thermo-Urethane (Maroon/Grey)	600	1-3/16"	WH5X2TUM19
		Mold-on Poly	1100	1-3/16"	WH5X2MOP19
		Mold-on Rubber	400	1-3/16"	WH5X2MOR19
		Thermo-Rubber (Flat)	350	1-3/16"	WH5X2TPR19
		Thermo-Rubber (Donut)	350	1-3/16"	WH5X2TPD19
		Phenolic	1000	1-3/16"	WH5X2PHN19
6"	2"	Polypropylene HD	600	1-3/16"	WH5X2POD19
		Cast Iron	1000	1-3/16"	WH5X2CIR19
		PolyKat™ Thermo-Urethane	1000	1/2"	WH6X2PKTP8
		Thermo-Urethane (Red/Black)	720	1-3/16"	WH6X2TPU19
		Thermo-Urethane (Maroon/Grey)	720	1-3/16"	WH6X2TUM19
		Mold-on Poly	1200	1-3/16"	WH6X2MOP19
		Mold-on Rubber	550	1-3/16"	WH6X2MOR19
		Thermo-Rubber (Flat)	500	1-3/16"	WH6X2TPR19
		Thermo-Rubber (Donut)	500	1-3/16"	WH6X2TPD19
8"	2"	Phenolic	1200	1-3/16"	WH6X2PHN19
		Polypropylene HD	600	1-3/16"	WH6X2POD19
		Cast Iron	1200	1-3/16"	WH6X2CIR19
		PolyKat™ Thermo-Urethane	1200	1/2"	WH8X2PKTP8
		Mold-on Poly	1250	1-3/16"	WH8X2MOP19
		Thermo-Urethane (Red/Black)	800	1-3/16"	WH8X2TPU19
		Thermo-Urethane (Maroon/Grey)	800	1-3/16"	WH8X2TUM19
		Mold-on Rubber	600	1-3/16"	WH8X2MOR19
		Thermo-Rubber (Flat)	600	1-3/16"	WH8X2TPR19
8"	2"	Thermo-Rubber (Donut)	600	1-3/16"	WH8X2TPD19
		Phenolic	1250	1-3/16"	WH8X2PHN19
		Polypropylene HD	900	1-3/16"	WH8X2POD19
		Cast Iron	1250	1-3/16"	WH8X2CIR19

Brakes

All brake kits include axle, nut and necessary hardware to install on swivel or rigid rigs.

Tread Lock Brake (TBK)



TBK4X2E	4" models
TBK5X2E	5" models
TBK6X2E	6" models
TBK8X2E	8" models

Wheel Face Brake (WFB)



WFB4X2E	4" models
WFB5X2E	5" models
WFB6X2E	6" models
WFB8X2E	8" models

Not available on 4" and 5" rigid models.

Long Pedal Cam Brake 7" (CAML)

Only works with roller bearing models. Fits 5", 6" & 8" E-Line models.



CAMXX2L	Comes with custom spanner bushing (roller bearing required)
---------	---

Short Pedal Cam Brake 5" (CAMS)

Only works with roller bearing models. Fits all caster sizes.



CAMXX2S	Comes with custom spanner bushing (roller bearing required)
---------	---

Hardware (All hardware parts sold per piece, not sets)



Axle (Zerk)
1/2-13x3.75
AXLEZRKEX2

Nut
1/2-13
AXLENUTEX2

Spanner bushing
1/2 X 3/4 X 2-7/16
SPANNEREX2



Retaining Washer (Plastic)
WHLCAPPLEX2

Retaining Washer (Steel)
WHLCAPSTEX2

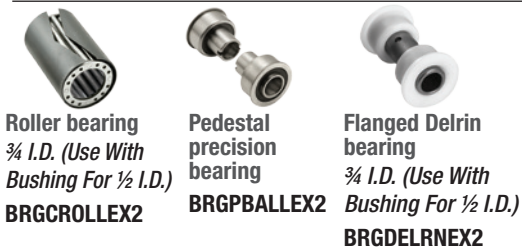

Roller bearing
3/4 I.D. (Use With Bushing For 1/2 I.D.)
BRGCROLLEX2

Pedestal precision bearing
BRGPBALLEX2

Flanged Delrin bearing
3/4 I.D. (Use With Bushing For 1/2 I.D.)
BRGDELRNEX2

Raceway Seals

Upper and Lower seals available on swivel caster models (Sold as set). Seals are not available for total lock models.



RCWYSEALEX2

4 Position Swivel Lock

Lock and unlock swivel for easy tracking down hallways



SWWLOCKX2

Floor Locks Designed to hold your portable equipment in a desired location.



Wheel Dia.	Caster Mtg. Ht.	Retracted Clearance	Approximate Weight (lbs)	Floor Lock #
4"	5-5/8"	3/4"	3-1/4	FL-4E
5"	6-1/2"	3/4"	3-1/2	FL-5E
6"	7-1/2"	3/4"	3-3/4"	FL-6E
8"	9-1/2"	3/4"	4"	FL-8E

Double Pedal Floor Locks Adaptable to all types of portable equipment, the double pedal floor lock allows for easier floor lock engagement.



Wheel Dia.	Caster Mtg. Ht.	Retracted Clearance	Approximate Weight (lbs)	Floor Lock #
4"	5-5/8"	1"	3-7/8	FLOCKE40
5"	6-1/2"	1"	4	FLOCKE50
6"	7-1/2"	1-3/8"	4-1/4	FLOCKE60
8"	9-1/2"	1-1/4"	4-3/4	FLOCKE80

02 14

Gate Casters CAPACITY TO 210



These casters are designed to make gate opening and closing easy. The casters feature gate mounts and spring loaded shock absorption.



Premium Quality



Environmentally Friendly

FEATURES

- Gate mount integrated in caster
- Spring loaded design provides shock absorption

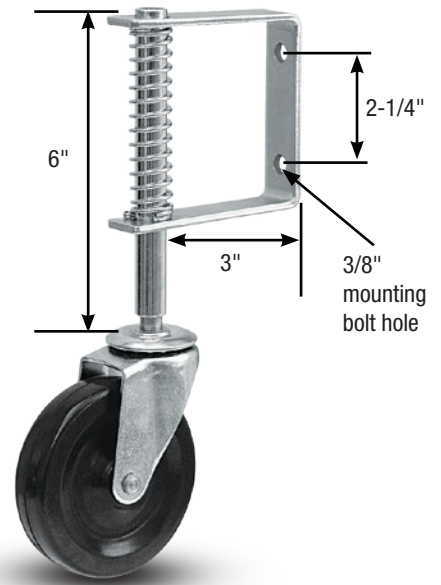



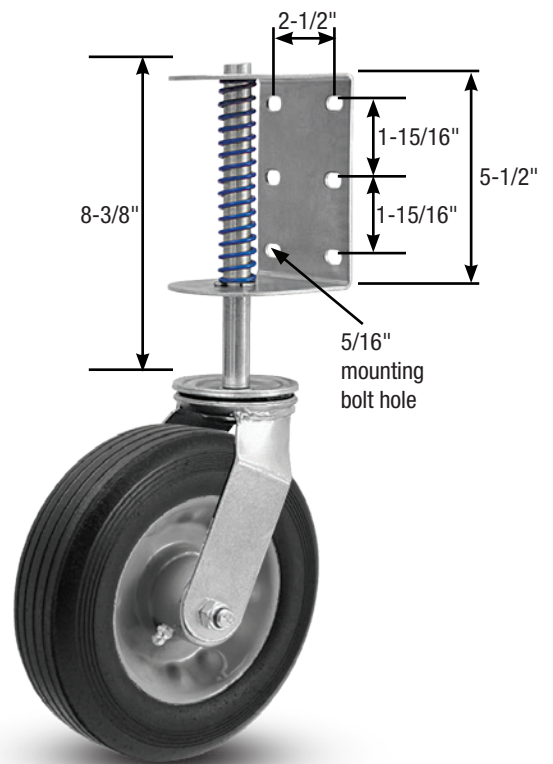

Wheel Diameter (Inches)	Tread Width/Type (Inches)	Capacity (Lbs) (Rates for manual operation)	Overall Height (Inches)	Swivel Lead (Inches)	Approx. Wt. (Lbs)	Caster Number
4	1	125	10-1/2	3.2		02RN04041S007



Wheel Diameter (Inches)	Tread Width/Type (Inches)	Capacity (Lbs) (Rates for manual operation)	Overall Height (Inches)	Swivel Lead (Inches)	Approx. Wt. (Lbs)	Caster Number
8	2-1/2	210	18-1/2	6.5		14SN08427S001

Wheel Visual Table of Contents

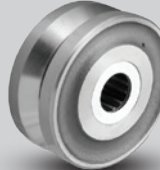

Metal Tread >>>

					
Cast Iron CA, CW, CH Pages 133-134	Flanged Cast Iron FL, FD Page 135	V-Groove Cast Iron VG, VL, VM Page 136	Ductile FM, FR Page 137	Drop Forged Steel FS, FH Page 138	Drop Forged Steel V-Groove VF, VH Page 139

Nylon Tread >>>

					
Maxim® NG Page 141	White Nylon NW Page 141	Trionix™ NX Page 142	Trionix™ V-Groove NV Page 142	High Heat Glass Filled HT Page 140	Heavy Duty Glass Filled DT Page 140

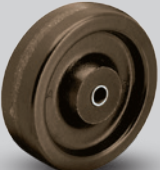

Phenolic Tread >>>

			
Phenolic Straight Sided TH, TS Page 143	Phenolic TM Page 143-144	Laminated Phenolic TL Page 144	Hi-Temp Phenolic TR Page 144



Polypropylene Tread >>>

	
Glass Filled RT Page 140	Polypropylene PB Page 145

Polypropylene Tread

	
Retort Hi-Temp Polypropylene RW Page 145	White Polypropylene PW Page 145

Polyurethane Tread >>>

			
Vulkollan® on Cast Iron VY Page 149	Thick Tread Vulkollan® VX Page 150	Polyurethane on Iron Core* PY, PH Pages 151-152	Thick Tread Polyurethane* PX Page 153

*PY, PH and PX available in multiple durometers.



Polyurethane Tread >>>



					
Polyurethane on Heavy Duty Cast Iron PF Page 154	Polyurethane on Cast Iron PI Page 154	Polyurethane Reactive PR Page 155	Polyurethane on Aluminum Core PA, PD Page 155	Round Tread Poly on Aluminum 95A PM Page 156	Round Tread Poly on Aluminum 80A PM 80A Page 156

Wheel Visual Table of Contents

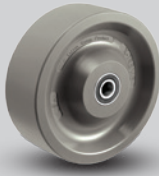
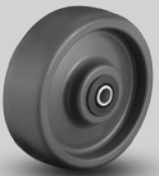

Polyurethane Tread >>>

					
Polyurethane on Aluminum 85A AX Page 156	Magnum Round on Aluminum 95A UA Page 157	Magnum Round on Aluminum 80A UA 80A Page 157	Magnum Round on Aluminum 73D UA 73D Page 157	Magnum Round on Aluminum 70A UA 70A Page 157	Aubin Industries Swivel-EAZ® EY, EZ Page 158

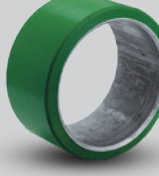
Polyurethane Tread >>>

					
X-Treme Solid Polyurethane XI Page 160	X-Treme Plus Solid Polyurethane XP Page 160	Solid Elastomer SE Page 161	Polyurethane on Polypropylene XA Page 161	Premium Poly on Polypropylene EG Page 162	Polyurethane Press-On Tire OG Page 163-164

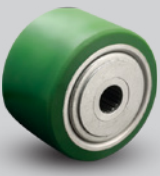
Polyurethane Tread

	
Mini Polyurethane Press-On Tire OG Page 165	Polyurethane V-Groove XV Page 165

Rubber Tread >>>

			
Full Pneumatic SF, SG Page 167	Hand Truck Wheel SO Page 168	Semi-Pneumatic SN Page 168	Monoprene Semi-Pneumatic SZ, SV Page 169

Rubber Tread >>>







					
Never Flat Tire NF Page 170	Ultimate Extra Soft Flat Tread XS, XY Page 171	Ultimate Extra Soft Round Tread XR Page 172	Heavy Duty Mold-On Rubber on Iron Core MH Page 173	Mold-On Rubber on Iron Core MR Pages 173-174	Mold-On Rubber on Die Cast Aluminum MD Page 175

Rubber Tread



			
Neoprene on Aluminum Flat Tread MG Page 176	Neoprene on Aluminum Round Tread NP Page 176	Rubber Press-On OA Page 177	Solid Rubber RR, RN Page 175

HARD TREAD WHEELS

Cast Iron Tread Wheels

 Cast Iron (CA, CW, CH).....	133-134
 Single Flange (FL).....	135
 Double Flange (FD).....	135
 Cast Iron V-Groove (VG/VL).....	136
 Ductile V-Groove (VM).....	136
 Ductile Iron (Flat & Crowned) FM/FR.....	137





Steel Tread Wheels

 Drop Forged and Large Bore Forged (FS/FH).....	138
 Drop Forged V-Groove (VF/VH).....	139





Glass Filled Polypropylene Wheels

 Glass Filled Polypropylene (RT).....	140
--	-----



Nylon Tread Wheels

 Glass Filled Nylon (HT/DT).....	140
 Maxim® Glass-filled Nylon (NG).....	141
 White Nylon Wheels (NW).....	141
 Trionix™ High Impact Polymer (NX).....	142
 Trionix™ High Impact Polymer V-Groove (NV).....	142

Phenolic Wheels

 Straight Sided Phenolic (TH/TS).....	143
 Phenolic (TM).....	143-144
 Heat Resistant Phenolic (TR).....	144
 Laminated Phenolic (TL).....	144

Polypropylene Wheels

 Polypropylene (PB).....	145
 White Polypropylene (PW).....	145
 RETORT Polypropylene (RW).....	145

CA



Premium Quality



Heat Resistant

Cast Iron



Premium cast iron, sometimes referred to as semi-steel, offers the highest tensile strength in the industry (30,000 psi). CA wheels are a cost-effective solution for high capacity applications.

FEATURES

- **Wheel face:** Machined flat with rounded edges
- **Finish:** Gray enamel
- **Temperature Range:** Up to +800°F, consult factory for high temperature requirements
- **Hardness:** Brinell 145

WHEEL OPTIONS

- Note: Select bearings featured are recommended for standard applications. For special applications or alternate bearings consult factory. See bearing information on page 13
- For customization & special application options, please consult factory

Cast Iron Wheels (CA)										Wheel Number Tapered Roller (09)	Wheel Number Plain Bore (41)
Wheel Diameter (Inches)	Tread Width (Inches)	Capacity (Lbs) (Based on minimal operation)	Hub Length (Inches)	Bore ID (Inches)	Bearing ID (Inches)	Approx. Wt. (Lbs)	Wheel Number Roller Bearing (01, 05, 07)				
3	1-1/4	300	1-1/2	1/2	-	1-1/4				CA0304108	
3	1-5/16	300	1-3/8	1-1/16	1/2	1-1/4	CA0300108				
3-1/4	1-1/2	400	1-5/8	1-3/16	1/2	1	CA0310108				
3-1/4	1-1/2	400	1-5/8	1-3/16	5/8	1	CA0310110				
3-1/4	1-1/2^A	400	1-5/8	1-3/16	3/4	1	CA0310112~				
3-1/4	2	700	2-3/16	1-3/16	1/2	3-1/4	CA0320108				
3-1/4	2	700	2-3/16	1-3/16	5/8	3-1/4	CA0320110				
3-1/4	2	700	2-3/16	1-3/16	3/4	3-1/4	CA0320112~				
3-1/4	4	2000	4-1/2	1-15/16	3/4	6-1/2		CA0370912			
3-1/2	1-1/4	350	1-1/2	1/2	-	1				CA03X4108	
4	1-1/4	350	1-3/8	1/2	1/2	1-3/4				CA0404108	
4	1-5/16	350	1-3/8	1-1/16	1/2	1-3/4	CA0400108				
4	1-1/2	600	1-5/8	1-3/16	1/2	2-1/4	CA0410108				
4	1-1/2	600	1-5/8	1-3/16	5/8	2-1/4	CA0410110				
4	1-1/2^A	600	1-5/8	1-3/16	3/4	2-1/4	CA0410112~				
4	1-7/8	1000	2-3/16	1-7/16	1/2	3-1/4	CA0420108				
4	1-7/8	1000	2-3/16	1-7/16	5/8	3-1/4	CA0420110				
4	1-7/8	1000	2-3/16	1-3/16	3/4	3-1/4	CA0420112~				
4	3	2000	3-1/4	1-15/16	1	8-1/4	CA0450116				
4	3	2000	3-1/4	1-15/16	1-1/4	8-1/4	CA0450120				
4	4	4000	4-1/4	2-7/16	1-1/4	10-3/4	CA0470120*				
4	4	4000	4-1/4	2-7/16	1-1/2	10-3/4	CA0470124*				
5	1-1/4	350	1-1/2	1/2	-	2-1/4				CA0504108	
5	1-5/16	350	1-3/8	1-1/16	1/2	2-1/4	CA0500108				
5	1-1/2	600	1-5/8	1-3/16	1/2	3-1/4	CA0510108				
5	1-1/2	600	1-5/8	1-3/16	5/8	3-1/4	CA0510110				
5	1-1/2^A	600	1-5/8	1-3/16	3/4	3-1/4	CA0510112~				
5	1-7/8	1300	2-3/16	1-3/16	1/2	4-1/4	CA0520108				
5	1-7/8	1300	2-3/16	1-3/16	5/8	4-1/4	CA0520110				
5	1-7/8	1300	2-3/16	1-3/16	3/4	4-1/4	CA0520112~				
5	2-1/8	1500	2-3/16	1-7/16	7/8	5-1/4	CA0530114				
5	2-1/8	1500	2-3/16	1-7/16	1	5-1/4	CA0530116				
5	2-1/2	2300	3-1/4	1-15/16	1	10	CA0540116				
5	2-1/2	2300	3-1/4	1-15/16	1-1/4	10	CA0540120				
6	1-1/2	800	1-5/8	1-3/16	1/2	4	CA0610108				
6	1-1/2	800	1-5/8	1-3/16	5/8	4	CA0610110				
6	1-1/2^A	800	1-5/8	1-3/16	3/4	4	CA0610112~				
6	1-7/8	1400	2-3/16	1-3/16	1/2	6-1/4	CA0620108				
6	1-7/8	1400	2-3/16	1-3/16	5/8	6-1/4	CA0620110				
6	1-7/8	1400	2-3/16	1-3/16	3/4	6-1/4	CA0620112~				
6	2-1/2	2300	3-1/4	1-15/16	1	10-1/4	CA0640116				
6	2-1/2	2300	3-1/4	1-15/16	1-1/4	10-1/4	CA0640120				
6	2-1/2	1600	2-3/4	1-3/16	3/4	7-1/2	CA0640712				
6	2-1/2	1800	2-3/4	1-15/16	1	9-1/2	CA0640516				
6	2-1/2	2300	3-1/2	1-15/16	3/4	10		CA0640912			
6	3	2800	3-1/4	1-15/16	1	11-3/4	CA0650116				
6	3	2800	3-1/4	1-15/16	1-1/4	11-3/4	CA0650120				
6	3	2800	3-1/2	1-15/16	3/4	11-1/2		CA0650912			
8	2	1800	2-3/16	1-3/16	1/2	8-1/2	CA0820108				
8	2	1800	2-3/16	1-3/16	5/8	8-1/2	CA0820110				
8	2	1800	2-3/16	1-3/16	3/4	8-1/2	CA0820112~				
8	2-1/2	2300	3-1/4	1-15/16	1	13-1/4	CA0840116				
8	2-1/2	2300	3-1/4	1-15/16	1-1/4	13-1/4	CA0840120				
8	2-1/2	1600	2-3/4	1-3/16	3/4	10	CA0840712				
8	2-1/2	1800	2-3/4	1-15/16	1	13	CA0840516				
8	3	2800	3-1/4	1-15/16	1	11-3/4	CA0850116				
8	3	2800	3-1/4	1-15/16	1-1/4	11-3/4	CA0850120				
8	3	2800	3-1/2	1-15/16	3/4	11-1/2		CA0850912			
8	4	4000	4-1/4	2-7/16	1-1/4	27-1/4	CA0870120				
8	4	4000	4-1/4	2-7/16	1-1/2	27-1/4	CA0870124				
8	4	6000	4-1/2	2-7/16	1	26-1/2		CA0870916			
8	4	6000	4-1/2	2-7/16	1-1/4	26-1/2		CA0870920			
10	2-1/2	2300	3-1/4	1-15/16	1	17-1/2	CA1040116				
10	2-1/2	2300	2-3/4	1-15/16	1	17-1/2	CA1040516				
10	2-1/2	2300	3-1/4	1-15/16	1-1/4	17-1/2	CA1040120				

~ Nylon retainer thrust washers & hardened metal spanner bushing included.
 ^ 27/16" spanner and spacers included. * Crown face

Continue on next page >>

CAST IRON WHEELS • UP TO 8000



Continued from previous page

See previous page for CA description and product details.



Premium Quality



Heat Resistant



Large bore premium cast iron, sometimes referred to as semi-steel, offers the highest tensile strength in the industry (30,000 psi). CW wheels are a cost-effective solution for high capacity applications. See CA cast iron for features and options.



Premium Quality



Heat Resistant



Heavy duty premium cast iron, sometimes referred to as semi-steel, offers the highest tensile strength in the industry (30,000 psi). These wheels are a cost-effective solution for high capacity applications. See CA cast iron for features and options.

Wheel Diameter (Inches)	Tread Width (Inches)	Capacity (Lbs) (Based on manual operation)	Hub Length (Inches)	Bore ID (Inches)	Bearing ID (Inches)	Approx. Wt. (Lbs)	Wheel Number Roller Bearing (01, 05, 07)	Wheel Number Tapered Roller (09)	Wheel Number Plain Bore (41)
Cast Iron Wheels (CA)									
10	3	2800	3-1/4	1-15/16	1	16-3/4	CA1050116		
10	3	2800	3-1/4	1-15/16	1-1/4	16-3/4	CA1050120		
10	3	2800	3-1/2	1-15/16	3/4	16-1/2		CA1050912	
10	4	4000	4-1/4	2-7/16	1-1/4	33	CA1070120		
10	4	4000	4-1/4	2-7/16	1-1/2	33	CA1070124		
10	4	6000	4-1/2	2-7/16	1	32-1/2		CA1070916	
10	4	6000	4-1/2	2-7/16	1-1/4	32-1/2		CA1070920	
12	2-1/2	1800	2-3/4	1-15/16	1	20-1/2	CA1240516		
12	2-1/2	2300	3-1/4	1-15/16	1	20-1/2	CA1240116		
12	2-1/2	2300	3-1/4	1-15/16	1-1/4	20-1/2	CA1240120		
12	3	2800	3-1/4	1-15/16	1	22	CA1250116		
12	3	2800	3-1/4	1-15/16	1-1/4	22	CA1250120		
12	3	2800	3-1/2	1-15/16	3/4	21-3/4		CA1250912	
12	3-1/2	4000	4-1/4	2-7/16	1-1/4	35-1/2	CA1260120		
12	3-1/2	4000	4-1/4	2-7/16	1-1/2	35-1/2	CA1260124		
12	3-1/2	4000	4-1/2	2-7/16	1	35		CA1260916	
12	3-1/2	4000	4-1/2	2-7/16	1-1/4	35		CA1260920	
14	4	4000	4-1/4	2-7/16	1-1/4	49-1/2	CA1470120		
14	4	4000	4-1/4	2-7/16	1-1/2	49-1/2	CA1470124		
16	3	4000	4-1/4	2-7/16	1-1/4	52-1/4	CA1650120		
16	3	4000	4-1/4	2-7/16	1-1/2	52-1/4	CA1650124		
16	4	5000	5-1/4	2-7/16	1-1/4	65-1/4	CA1670120		
16	4	5000	5-1/4	2-7/16	1-1/2	65-1/4	CA1670124		
18	3	4000	4-1/4	2-7/16	1-1/4	58	CA1850120		
18	3	4000	4-1/4	2-7/16	2	58	CA1850124		

Wheel Diameter (Inches)	Tread Width (Inches)	Capacity (Lbs) (Based on manual operation)	Hub Length (Inches)	Bore ID (Inches)	Bearing ID (Inches)	Approx. Wt. (Lbs)	Wheel Number Roller Bearing (01)	Wheel Number Bronze Bearing (22)*	Wheel Number Annular Ball Bearing (31)
Large Bore Premium Cast Iron Wheels (CW)									
8	3	6000	3-1/4	2-7/16	1-1/4	21-3/4	CW0850120		
8	3	6000	3-1/4	2-7/16	1-1/2	21-3/4	CW0850124		
8	3	8000	3-1/2	2-7/16	1	21-1/2		CW0850916	
8	3	8000	3-1/2	2-7/16	1-1/4	21-1/2		CW0850920	

Wheel Diameter (Inches)	Tread Width (Inches)	Capacity (Lbs) (Based on manual operation)	Hub Length (Inches)	Bore ID (Inches)	Bearing ID (Inches)	Approx. Wt. (Lbs)	Wheel Number Roller Bearing (01)	Wheel Number Bronze Bearing (22)*	Wheel Number Annular Ball Bearing (31)
Heavy Duty Cast Iron Wheels (CH)									
5	2	1500	2-3/16	1-3/16	1/2	4-1/4	CH0520108		CH0523108
5	2	1500	2-3/16	1-3/16	5/8	4-1/4	CH0520110		
5	2	1500	2-3/16	1-3/16	3/4	4-1/4	CH0520112~	CH0522212	
6	2	1700	2-3/16	1-3/16	1/2	6-1/4	CH0620108		CH0623108
6	2	1700	2-3/16	1-3/16	5/8	6-1/4	CH0620110		
6	2	1700	2-3/16	1-3/16	3/4	6-1/4	CH0620112~	CH0622212	
8	2	1800	2-3/16	1-3/16	1/2	8-1/2	CH0820108		CH0823108
8	2	1800	2-3/16	1-3/16	5/8	8-1/2	CH0820110		
8	2	1800	2-3/16	1-3/16	3/4	8-1/2	CH0820112~	CH0822112	

~ Nylon retainer thrust washers & hardened metal spanner bushing included.

* Hub length increases to 2-3/8" on bronze bearings.

FL Single Flange

Premium Quality

Heat Resistant

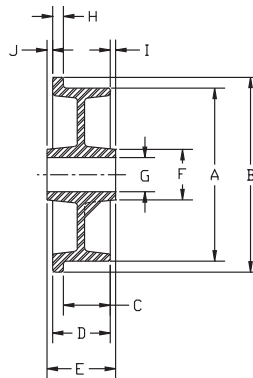

Letters match to chart descriptions below.

Various bore sizes are available for FL for use as plain bore wheels or to be used with keyway and set screw or with a variety of bearings. This cast iron wheel offers 30,000 psi tensile strength.

FEATURES

- Finish:** Gray enamel
- Temperature Range:** Up to +800°F, consult factory for high temperature requirements
- Hardness:** Brinell 145

WHEEL OPTIONS

- Note: Select bearings featured are recommended for standard applications. For special applications or alternate bearings consult factory. See bearing information on page 13
- For customization & special application options, please consult factory

Face Diameter "A" (Inches)	Flange OD "B" (Inches)	Face Width "C" (Inches)	O.A. Width "D" (Inches)	Hub Length "E" (Inches)	Hub O.D. "F" (Inches)	Bore "G" (Inches)	Flange Width "H" (Inches)	Hub Offset "I" (Inches)	Hub Offset "J" (Inches)	Capacity (Lbs.)	Bearing Size (Inches)	Approx. Wt. (Lbs.)	Wheel Number Straight Roller (01)	Wheel Number Tapered Roller (09)
Single Flange (FL)														
3	4	1	1-3/8	2-3/16	1-5/8	1-3/16	3/8	9/16	1/4	700	3/4	3	FL0320112	
3-1/4	4	1	1-3/8	2-3/16	1-3/4	1-3/16	3/8	19/32	7/32	700	3/4	3	FL0310112	
4-1/2	5-1/2	1-9/16	2-3/8	2-1/2	2-1/2	1-15/16	13/16	1/16	1/16	1500	1	9-1/2	FL0410116	FL0410912
4-1/2	5-1/2	1-9/16	2-3/8	2-1/2	2-1/2	1-15/16	13/16	1/16	1/16	1500	3/4	9-1/2		
5	6	1-1/8	1-1/2	2-3/16	1-3/4	1-3/16	3/8	11/32	11/32	500	3/4	5-1/4	FL0510112	
5-3/8	6-1/8	1-5/16	1-11/16	2-3/16	1-3/4	1-3/16	3/8	13/32	3/32	900	3/4	5	FL0520112	
5	6	1-1/8	1-15/16	3-1/4	2-1/2	1-15/16	13/16	15/16	3/8	1000	1	6-1/2	FL0520116	
5	6	1-1/8	1-15/16	3-1/2	2-1/2	1-15/16	13/16	15/16	3/8	1000	3/4	6-1/2		FL0520912
6	6-3/4	1-5/8	2	2-3/16	1-3/4	1-3/16	3/8	3/32	3/32	900	3/4	8-1/2	FL0620112	
7-1/16	8-3/4	1-3/4	2-3/16	2-3/4	2-5/8	1-15/16	7/16	9/32	9/32	1200	1	12-3/4	FL0720116	
7-1/16	8-3/4	1-3/4	2-3/16	3	2-5/8	1-15/16	7/16	9/32	9/32	1200	3/4	12-3/4		FL0720912
8	9-1/2	2	2-1/2	3-1/4	3	1-15/16	1/2	3/8	3/8	1600	1	16-1/4	FL0840116	
8	9-1/2	2	2-1/2	3-1/2	3	1-15/16	1/2	3/8	3/8	1600	3/4	16-1/4		FL0840912
10	12	2-3/8	3	3-1/4	3	1-15/16	5/8	1/8	1/8	2000	1	29-1/4	FL1050116	
10	12	2-3/8	3	3-1/2	3	1-15/16	5/8	1/8	1/8	2000	3/4	29-1/4		FL1050912
14	16	3	3-5/8	4-1/4	4-1/4	2-7/16	5/8	5/16	5/16	3000	1-1/4	56	FL1460120	
14	16	3	3-5/8	4-1/2	4-1/4	2-7/16	5/8	5/16	5/16	3000	1	56		FL1460916

FD Double Flange

Premium Quality

Heat Resistant



Face Diameter "A" (Inches)	Flange OD "B" (Inches)	Face Width "C" (Inches)	O.A. Width "D" (Inches)	Hub Length "E" (Inches)	Hub O.D. "F" (Inches)	Bore "G" (Inches)	Flange Width "H" (Inches)	Hub Offset "I" (Inches)	Hub Offset "J" (Inches)	Capacity (Lbs.)	Bearing Size (Inches)	Approx. Wt. (Lbs.)	Wheel Number Straight Roller (01)	Wheel Number Tapered Roller (09)
Double Flange (FD)														
5	6	3/4	1-1/2	2-3/16	1-3/4	1-3/16	3/8	11/32	11/32	500	3/4	6	FD0510112	
10	12	1-3/4	3	3-1/4	3	1-15/16	5/8	1/8	1/8	2000	1	35	FD1050116	
10	12	1-3/4	3	3-1/2	3	1-15/16	5/8	1/8	1/8	2000	3/4	35		FD1050912

FD offers various bore sizes for use as plain bore wheels or to be used with keyway and set screw or with a variety of bearings. This cast iron wheel offers 30,000 psi tensile strength. See FL for features and options.

CAST IRON WHEELS • UP TO 3000

VG/VL

 Premium Quality  Heat Resistant
Cast Iron V-Groove

Letters match to chart descriptions

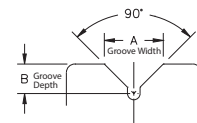

Wheel face and "V"-groove are machined from heavy duty cast iron. A relief groove at the base of the "V" tends to equalize the load to each face of the angle track when in operation. Wheel face and bore are machined for concentricity to proper tracking. These wheels can be used not only on track but flat surfaces as well. VL wheels feature a larger bore for greater capacity.

Please note: Track alignment is critical when utilizing v-groove wheels.

FEATURES

- **Wheel face:** V-Groove
- **Finish:** Silver Enamel Paint
- **Temperature Range:** Up to +350°F, consult factory for high temperature requirements
- **Hardness:** Brinell 145 **Tensile:** 30,000 psi

WHEEL OPTIONS

- Note: Select bearings featured are recommended for standard applications. For special applications or alternate bearings consult factory. See bearing information on page 13
- For customization & special application options, please consult factory



VM

Ductile V-Groove

Albion VM Ductile Wheels feature higher capacities compared to cast iron V-Groove wheels. Wheels are painted black.

Letters match to chart descriptions

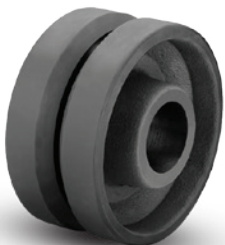
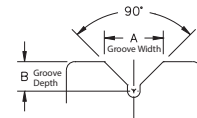

FEATURES

- **Wheel face:** V-Groove
- **Finish:** Flat Black Paint w/Rust Inhibitor
- **Temperature Range:** Up to +350°F, consult factory for high temperature requirements
- **Hardness:** Brinell 131 – 217 (mechanical properties ASTM A536 grade 65-45-12)
- **Tensile:** 65,000 psi

WHEEL OPTIONS

- Note: Select bearings featured are recommended for standard applications. For special applications or alternate bearings consult factory. See bearing information on page 13.
- For customization & special application options, please consult factory

Wheel Diameter (Inches)	Tread Width (Inches)	Capacity (Lbs) (Rated for manual operation)	Hub Length (Inches)	Bore ID (Inches)	Bearing ID (Inches)	Groove Width "A" (Inches)	Groove Depth "B" (Inches)	Approx. Wt. (Lbs)	Wheel Number Roller Bearing (O1)	Wheel Number Tapered Roller (O9)
4	2	800	2-3/16	1-3/16	5/8	7/8	7/16	4	VG0420110	
4	2	800	2-3/16	1-3/16	3/4	7/8	7/16	4	VG0420112~	
5	2	800	2-3/16	1-3/16	5/8	7/8	7/16	5	VG0520110	
5	2	800	2-3/16	1-3/16	3/4	7/8	7/16	5	VG0520112~	
6	2	1000	2-3/16	1-3/16	5/8	7/8	7/16	8	VG0620110	
6	2	1000	2-3/16	1-3/16	3/4	7/8	7/16	8	VG0620112~	
6	2-1/2	2500	3-1/4	1-15/16	1	7/8	7/16	11-3/4	VG0640116	
6	2-1/2	2500	3-1/4	1-15/16	1-1/4	7/8	7/16	11-3/4	VG0640120	
6	2-1/2	2500	3-1/2	1-15/16	3/4	7/8	7/16	11-1/2		VG0640912
8	2-1/2	2500	3-1/4	1-15/16	1	7/8	7/16	15-1/2	VG0840116	
8	2-1/2	2500	3-1/4	1-15/16	1-1/4	7/8	7/16	15-1/2	VG0840120	
8	2-1/2	2500	3-1/2	1-15/16	3/4	7/8	7/16	15-1/2		VG0840912
8	2-1/2	2500	3-1/2	2	1	7/8	7/16	15-1/2		VG0840916
8	3	2500	3-1/4	1-15/16	1	7/8	7/16	16-3/4	VG0850116	
8	3	2500	3-1/4	1-15/16	1-1/4	7/8	7/16	16-3/4	VG0850120	
8	3	2500	3-1/2	1-15/16	3/4	7/8	7/16	16-1/2		VG0850912
8	3	2500	3-1/2	2	1	7/8	7/16	16-1/2		VG0850916
8	3	4000	3-1/4	2-7/16	1-1/4	1-3/8	11/16	17-3/4	VL0850120	
8	3	4000	3-1/4	2-7/16	1-1/2	1-3/8	11/16	17-3/4	VL0850124	
8	3	4000	3-1/2	2-7/16	1	1-3/8	11/16	17-1/4		VL0850916
8	3	4000	3-1/2	2-7/16	1-1/4	1-3/8	11/16	17-1/4		VL0850920
10	3	3000	3-1/4	1-15/16	1	1-3/8	11/16	27	VG1050116	
10	3	3000	3-1/4	1-15/16	1-1/4	1-3/8	11/16	27	VG1050120	
10	3	3500	3-1/2	1-15/16	3/4	1-3/8	11/16	26-3/4		VG1050912
10	3	3500	3-1/2	2	1	1-3/8	11/16	26-3/4		VG1050916
10	3	4000	3-1/4	2-7/16	1-1/4	1-3/8	11/16	28	VL1050120	
10	3	4000	3-1/4	2-7/16	1-1/2	1-3/8	11/16	28	VL1050124	
10	3	4000	3-1/2	2-7/16	1	1-3/8	11/16	27-1/4		VL1050916
10	3	4000	3-1/2	2-11/32	1-1/4	1-3/8	11/16	27-1/4		VL1050920

~ Wheels are complete with spanner bushing and nylon sealed retaining/thrust washer.

Wheel Diameter (Inches)	Tread Width (Inches)	Capacity (Lbs) (Rated for manual operation)	Hub Length (Inches)	Bore ID (Inches)	Bearing ID (Inches)	Groove Width "A" (Inches)	Groove Depth "B" (Inches)	Approx. Wt. (Lbs)	Wheel Number Roller Bearing (O1)	Wheel Number Tapered Roller (O9)
6	2-1/2	3500	3-1/4	1-15/16	1	7/8	7/16	9-1/2	VM0640116	
6	2-1/2	3500	3-1/4	1-15/16	1-1/4	7/8	7/16	9-1/2	VM0640120	
6	2-1/2	3500	3-1/2	1-15/16	3/4	7/8	7/16	9-1/2		VM0640912
6	3	5000	3-1/4	1-15/16	1	7/8	7/16	10-1/2	VM0650116	
6	3	5000	3-1/4	1-15/16	1-1/4	7/8	7/16	10-1/2	VM0650120	
6	3	5000	3-1/2	1-15/16	3/4	7/8	7/16	10-1/2		VM0650912
8	3	5000	3-1/4	1-15/16	1	7/8	7/16	16-1/2	VM0850116	
8	3	5000	3-1/4	1-15/16	1-1/4	7/8	7/16	16-1/2	VM0850120	
8	3	5000	3-1/2	1-15/16	3/4	7/8	7/16	16-1/2		VM0850912
8	3	5000	3-1/2	1-15/16	1	7/8	7/16	16-1/2		VM0850916
10	3	6000	3-1/4	1-15/16	1	1-3/8	11/16	26	VM1050116	
10	3	6000	3-1/4	1-15/16	1-1/4	1-3/8	11/16	26	VM1050120	
10	3	6000	3-1/2	1-15/16	3/4	1-3/8	11/16	26		VM1050912
10	3	6000	3-1/2	1-15/16	1	1-3/8	11/16	26		VM1050916

4x2 and 6x2 models coming soon – consult factory.

FM



Premium Quality



Heat Resistant

Flat Tread Ductile



Albion FM Ductile Wheels feature higher capacities compared to cast iron wheels. Wheels are painted black.

FEATURES

- **Wheel face:** Flat tread design
- **Finish:** Black paint
- **Temperature Range:** Up to +800°F, consult factory for high temperature requirements
- **Tensile Strength:** 65K PSI

WHEEL OPTIONS

- Note: Select bearings featured are recommended for standard applications. For special applications or alternate bearings consult factory. See bearing information on page 13
- For customization & special application options, please consult factory

Wheel Diameter (Inches)	Tread Width (Inches)	Capacity (Lbs) (Based for manual operation)	Hub Length (Inches)	Bore ID (Inches)	Bearing ID (Inches)	Approx. Wt. (LBS)	Wheel Number Plain Bore (00)	Wheel Number Roller Bearing (01)	Wheel Number Tapered Roller (09)
Flat Tread Ductile Flat Tread Painted Black (FM)									
5	2	1500	2-3/16	1-3/16	3/4	6	FM0520019	FM0520112	
5	2	1500	2-7/16	1-3/8	1/2	6			FM0520908
6	2	1500	2-3/16	1-3/16	3/4	7-1/2	FM0620019	FM0620112	
6	2	2000	2-7/16	1-3/8	1/2	7-1/2			FM0620908
6	2-1/2	3500	3-1/4	1-15/16	1-1/4	10-1/2	FM0640031	FM0640120	
6	2-1/2	3500	3-1/2	1-15/16	3/4	10-1/2			FM0640912
6	3	6000	3-1/4	1-15/16	1-1/4	11-1/2	FM0650031	FM0650120	
6	3	6000	3-1/2	1-15/16	3/4	11-1/2			FM0650912
8	2	2000	2-3/16	1-3/16	3/4	11	FM0820019	FM0820112	
8	2	2000	2-7/16	1-3/8	1/2	11			FM0820908
8	3	6000	3-1/4	1-15/16	1	15-1/2	FM0850031	FM0850116	
8	3	6000	3-1/2	1-15/16	3/4	15-1/2			FM0850912
10	3	6000	3-1/4	1-15/16	1-1/4	20-1/2	FM1050031	FM1050120	
10	3	6000	3-1/2	1-15/16	3/4	20-1/2			FM1050912

Wheel Diameter (Inches)	Tread Width (Inches)	Capacity (Lbs) (Based for manual operation)	Hub Length (Inches)	Bore ID (Inches)	Bearing ID (Inches)	Approx. Wt. (LBS)	Wheel Number Plain Bore (00)	Wheel Number Roller Bearing (01)	Wheel Number Tapered Roller (09)
Flat Tread Ductile Flat Tread Unpainted (FM)									
12	3-1/2	6000	4-1/4	2-7/16	1-1/4	40-1/2		FM1260120	
12	3-1/2	6000	4-1/4	2-7/16	1-1/2	40-1/2		FM1260124	
12	3-1/2	6000	4-1/2	2-7/16	1	40			FM1260916
12	3-1/2	6000	4-1/2	2-7/16	1-1/4	40			FM1260920

3-1/2" tread width models are not painted.

FR



Premium Quality



Heat Resistant

Full Radius Ductile Tread



FR Full Radius Ductile Tread Design For Easier Maneuverability

Albion FR Ductile Wheels feature higher capacities compared to cast iron wheels. Full radius tread design makes them easier to swivel and roll. Wheels are painted black.

FEATURES

- **Wheel face:** Full radius tread design
- **Finish:** Black paint
- **Temperature Range:** Up to +800°F, consult factory for high temperature requirements
- **Tensile Strength:** 65K PSI

WHEEL OPTIONS

- Note: Select bearings featured are recommended for standard applications. For special applications or alternate bearings consult factory. See bearing information on page 13
- For customization & special application options, please consult factory

Wheel Diameter (Inches)	Tread Width (Inches)	Capacity (Lbs) (Based for manual operation)	Hub Length (Inches)	Bore ID (Inches)	Bearing ID (Inches)	Approx. Wt. (LBS)	Wheel Number Plain Bore (00)	Wheel Number Roller Bearing (01)	Wheel Number Tapered Roller (09)
Full Radius Tread Ductile (FR)									
5	2	1500	2-3/16	1-3/16	3/4	6	FR0520019	FR0520112	
5	2	1500	2-7/16	1-3/8	1/2	6			FR0520908
6	2	2000	2-3/16	1-3/16	3/4	7-1/2	FR0620019	FR0620112	
6	2	2000	2-7/16	1-3/8	1/2	7-1/2			FR0620908
6	2-1/2	3500	3-1/4	1-15/16	1-1/4	10-1/2	FR0640031	FR0640120	
6	2-1/2	3500	3-1/2	1-15/16	3/4	10-1/2			FR0640912
6	3	6000	3-1/4	1-15/16	1-1/4	11-1/2	FR0650031	FR0650120	
6	3	6000	3-1/2	1-15/16	3/4	11-1/2			FR0650912
8	2	1500	2-3/16	1-3/16	3/4	11	FR0820019	FR0820112	
8	2	2000	2-7/16	1-3/8	1/2	11			FR0820908
8	3	6000	3-1/4	1-15/16	1-1/4	15-1/2	FR0850031	FR0850120	
8	3	6000	3-1/2	1-15/16	3/4	15-1/2			FR0850912
10	3	6000	3-1/4	1-15/16	1-1/4	20-1/2	FR1050031	FR1050120	
10	3	6000	3-1/2	1-15/16	3/4	20-1/2			FR1050912

CAST IRON WHEELS • UP TO 6000

FS



Drop Forged Steel



Heat Resistant



Drop forged steel wheels are hot forged from carbon steel billets. The forging process improves grain flow, enhances ductility and tensile strength. Suitable for high capacity, abusive applications. Forged steel is 64,000 psi tensile strength.

FEATURES

- **Wheel face:** Machined flat with rounded edges
- **Finish:** Clear coat enamel
- **Temperature Range:** Up to +800°F, consult factory for high temperature requirements
- **Hardness:** Rockwell 80 B

WHEEL OPTIONS

- Note: Select bearings featured are recommended for standard applications. For special applications or alternate bearings consult factory. See bearing information on page 13
- For customization & special application options, please consult factory

Wheel Diameter (Inches)	Tread Width (Inches)	Capacity (Lbs) (Rated for normal operation)	Hub Length (Inches)	Bore ID (Inches)	Bearing ID (Inches)	Approx. Wt. (Lbs)	Wheel Number Roller Bearing (01)	Wheel Number Tapered Roller (08, 09)
Drop Forged Steel Wheels (FS)								
4	1-1/2	1400	2-3/16	1-3/16	1/2	3-1/4	FS0410108	
4	1-1/2	1400	2-3/16	1-3/16	5/8	3-1/4	FS0410110	
4	1-1/2	1400	2-3/16	1-3/16	3/4	3-1/4	FS0410112~	
4	1-1/2	1400	2-7/16	1-3/8	1/2	3-1/4		FS0410908
5	1-3/4	1500	2-3/16	1-3/16	1/2	5-1/4	FS0520108	
5	1-3/4	1500	2-3/16	1-3/16	5/8	5-1/4	FS0520110	
5	1-3/4	1500	2-3/16	1-3/16	3/4	5-1/4	FS0520112~	
5	1-3/4	1800	2-7/16	1-3/8	1/2	5-1/4		FS0520908
6	2	1700	2-3/16	1-3/16	1/2	6-1/4	FS0620108	
6	2	1700	2-3/16	1-3/16	5/8	6-1/4	FS0620110	
6	2	1700	2-3/16	1-3/16	3/4	6-1/4	FS0620112~	
6	2	2500	2-7/16	1-3/8	1/2	6-1/4		FS0620908
6	2	2500	2-7/16	1-7/8	3/4	6-1/4		FS0620912
6	2-1/2	4000	3-1/4	1-15/16	1	11-3/4	FS0640116	
6	2-1/2	4000	3-1/4	1-15/16	1-1/4	11-3/4	FS0640120	
6	2-1/2	5000	3-1/2	1-7/8	3/4	11-1/4		FS0640912
6	2-1/2	5000	3-1/2	2-1/4	1	11-3/4		FS0640916
6	3	6000	3-1/4	2-7/16	1-1/4	20-1/4	FS0650120	
6	3	6000	3-1/2	2-7/16	1-1/2	20-1/4	FS0650124	
6	3	10000	3-1/2	2-7/16	1	19-3/4		FS0650916
6	3	10000	3-1/2	2-7/16	1-1/8	19-3/4		FS0650918
6	3	10000	3-1/2	2-7/16	1-1/4	19-3/4		FS0650920
8	2-1/2	4000	3-1/4	1-15/16	1	18	FS0840116	
8	2-1/2	4000	3-1/4	1-15/16	1-1/4	18	FS0840120	
8	3	4500	3-1/4	1-15/16	1	18-1/4	FS0850116	
8	3	4500	3-1/4	1-15/16	1-1/4	18-1/4	FS0850120	
8	3	5500	3-1/2	1-15/16	3/4	18-1/4		FS0850912
8	3	5500	3-1/2	2-1/4	1	18-1/4		FS0850916
8	4	8350	4-1/4	2-7/16	1-1/4	35-1/2	FS0870120	
8	4	8350	4-1/4	2-7/16	1-1/2	35-1/2	FS0870124	
8	4	10000	4-1/2	2-7/16	1	36-1/2		FS0870916
8	4	10000	4-1/2	2-7/16	1-1/8	36-1/2		FS0870918
8	4	10000	4-1/2	2-7/16	1-1/4	36-1/2		FS0870920
10	3	5000	3-1/4	1-15/16	1	27-3/4	FS1050116	
10	3	5000	3-1/4	1-15/16	1-1/4	27-3/4	FS1050120	
10	3	6000	3-1/2	1-15/16	3/4	27-1/2		FS1050912
10	4	8350	4-1/4	2-7/16	1-1/4	48	FS1070120	
10	4	8350	4-1/4	2-7/16	1-1/2	48	FS1070124	
10	4	10000	4-1/2	2-7/16	1	47-1/4		FS1070916
10	4	10000	4-1/2	2-7/16	1-1/8	47-1/4		FS1070918
10	4	10000	4-1/2	2-7/16	1-1/4	47-1/4		FS1070920

~ Wheels are complete with spanner bushing and nylon sealed retaining/thrust washer.

FH



Large Bore Drop Forged Steel



These dropped forged steel wheels are a large bore version of FS wheels. See FS wheels for features and options.

Up to 20,000 lbs Capacity!

Wheel Diameter (Inches)	Tread Width (Inches)	Capacity (Lbs) (Rated for normal operation)	Hub Length (Inches)	Bore ID (Inches)	Bearing ID (Inches)	Approx. Wt. (Lbs)	Wheel Number Roller Bearing (01)	Wheel Number Tapered Roller (09)
Large Bore Drop Forged Steel Wheels (FH)								
6	3	17000	3-1/2	3-1/8	1-1/4	22-1/4		FH0650920
6	3	17000	3-1/2	3-1/8	1-1/2	22-1/4		FH0650924
8	3	6500	3-1/4	2-7/16	1-1/4	34	FH0850120	
8	4	20000	4-1/2	3-1/8	1-1/4	34		FH0870920
8	4	20000	4-1/2	3-1/8	1-1/2	34		FH0870924
10	3	6000	3-1/4	2-7/16	1-1/4	37-1/4	FH1050120	
10	3	6000	3-1/4	2-7/16	1-1/2	37-1/4	FH1050124	
10	3	6500	3-1/2	2-7/16	1	37		FH1050916
10	3	6500	3-1/2	2-7/16	1-1/4	37		FH1050920
10	4	20000	4-1/2	3-1/8	1-1/4	46-1/4		FH1070920
10	4	20000	4-1/2	3-1/8	1-1/2	46-1/4		FH1070924

VF/VH



Premium Quality



Heat Resistant

Drop Forged Steel V-Groove

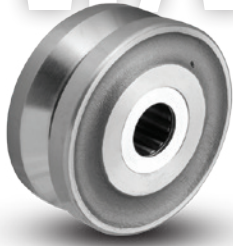

Wheel face and "V"-groove are machined from drop forged steel. A relief groove at the base of the "V" tends to equalize the load to each face of the angle track when in operation. Wheel face and bore are machined for concentricity to proper tracking. These wheels can be used not only on a track but flat surfaces as well. VH wheels feature a larger bore for greater capacity.

Please note: Track alignment is critical when utilizing v-groove wheels.

FEATURES

- **Wheel face:** V-Groove
- **Finish:** Clear Coat Enamel w/Rust Inhibitor
- **Temperature Range:** Up to +350°F, consult factory for high temperature requirements
- **Hardness:** Brinell 149 (converted from Rockwell 80 B)
- **Tensile:** 64,000 psi

WHEEL OPTIONS

- Note: Select bearings featured are recommended for standard applications. For special applications or alternate bearings consult factory. See bearing information on page 13
- For customization & special application options, please consult factory

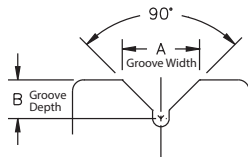

Letters match to chart descriptions

Wheel Diameter (Inches)	Tread Width (Inches)	Capacity (Lbs) (rated for manual operation)	Hub Length (Inches)	Bore ID (Inches)	Bearing ID (Inches)	Groove Width "A" (Inches)	Groove Depth "B" (Inches)	Approx. Wt. (Lbs)	Wheel Number Roller Bearing (01)	Wheel Number Tapered Roller (09)
Drop Forged Steel V-Groove (VF, VH)										
6	3	6000	3-1/4	2-7/16	1-1/4	1-3/8	11/16	20-1/4	VF0650120	
6	3	6000	3-1/4	2-7/16	1-1/2	1-3/8	11/16	20-1/4	VF0650124	
6	3	10000	3-1/2	2-7/16	1	1-3/8	11/16	19-3/4		VF0650916
6	3	10000	3-1/2	2-7/16	1-1/4	1-3/8	11/16	19-3/4		VF0650920
6	3	15000	3-1/2	3-1/8	1-1/4	1-3/8	11/16	22		VH0650920
6	3	15000	3-1/2	3-1/8	1-1/2	1-3/8	11/16	22		VH0650924
8	3	6000	3-1/4	1-15/16	1	7/8	7/16	30	VF0850116	
8	4	8350	4-1/4	2-7/16	1-1/4	1-3/4	7/8	21-3/4	VF0870120	
8	4	8350	4-1/4	2-7/16	1-1/2	1-3/4	7/8	21-3/4	VF0870124	
8	4	10000	4-1/2	2-7/16	1	1-3/4	7/8	21		VF0870916
8	4	10000	4-1/2	2-7/16	1-1/4	1-3/4	7/8	21		VF0870920
8	4	15000	4-1/2	3-1/8	1-1/4	1-3/4	7/8	27-1/2		VH0870920
8	4	15000	4-1/2	3-1/8	1-1/2	1-3/4	7/8	27-1/2		VH0870924
10	3	6000	3-1/4	2-7/16	1-1/4	1-3/8	11/16	37-1/2	VH1050120	
10	3	6000	3-1/4	2-7/16	1-1/2	1-3/8	11/16	37-1/2	VH1050124	
10	3	6000	3-1/2	2-7/16	1	1-3/8	11/16	37		VH1050916
10	3	6000	3-1/2	2-7/16	1-1/4	1-3/8	11/16	37		VH1050920
10	3	5000	3-1/4	1-15/16	1	1-3/8	11/16	27-3/4	VF1050116	
10	3	5000	3-1/4	1-15/16	1-1/4	1-3/8	11/16	27-3/4	VF1050120	
10	4	8350	4-1/4	2-7/16	1-1/4	1-3/4	7/8	48	VF1070120	
10	4	8350	4-1/4	2-7/16	1-1/2	1-3/4	7/8	48	VF1070124	
10	4	10000	4-1/2	2-7/16	1	1-3/4	7/8	47-1/4		VF1070916
10	4	10000	4-1/2	2-7/16	1-1/4	1-3/4	7/8	47-1/4		VF1070920
10	4	15000	4-1/2	3-1/8	1-1/4	1-3/4	7/8	46-1/4		VH1070920
10	4	15000	4-1/2	3-1/8	1-1/2	1-3/4	7/8	46-1/4		VH1070924

FORGED STEEL WHEELS • UP TO 15000



Economical

RT Glass Filled Polypropylene



Premium Quality



Heat Resistant

HT High Heat Glass Filled Nylon



Premium Quality



Heat Resistant

DT Heavy Duty Glass Filled Nylon



Need tough, heat resistant wheels? Albion offers three versions: the RT, HT, and the newest addition to the family, the DT. These wheels are ideal for food processing, tool storage, sanitary maintenance, and applications requiring easy mobility under heavy loads. All three are extremely resistant to water, chemical absorption, steam cleaning, and HEAT!

FEATURES

- **Wheel face:** Moderate crown
- **Finish:** RT & HT (Black) DT (Dark Grey)
- **Material:**

RT: Glass filled polypropylene

HT: Glass filled nylon designed for higher temperature applications

DT: Heavy duty version of the RT wheels with regards to impact and load capacity and are made from a glass filled nylon with impact modifiers and temperature stabilization formulation

- **Temperature Range:**

RT: -20°F to +250°F

HT: -20°F to +480°F

DT: -20°F to +350°F

- **Hardness:**

RT: 65-70 Shore D

HT: 75-80 Shore D

DT: 75-80 Shore D

Glass Filled Polypropylene (RT)							Wheel Number Roller Bearing (01)	Wheel Number Precision Ball Bearing (28)	Wheel Number Pedestal Precision Ball Bearing (29)
Wheel Diameter (Inches)	Tread Width (Inches)	Capacity (Lbs) (Rated for manual operation)	Hub Length (Inches)	Bore ID (Inches)	Bearing ID (Inches)				
4	2	800	2-3/16	1-3/16	3/4	RT0420112			
4	2	800	2-3/16	1-3/16	1/2		RT0422808*	RT0422908	
5	2	1000	2-3/16	1-3/16	3/4	RT0520112			
5	2	1000	2-3/16	1-3/16	1/2		RT0522808*	RT0522908	
6	2	1200	2-3/16	1-3/16	3/4	RT0620112			
6	2	1200	2-3/16	1-3/16	1/2		RT0622808*	RT0622908	
8	2	1400	2-3/16	1-3/16	3/4	RT0820112~			
8	2	1400	2-3/16	1-3/16	3/4		RT0822808*	RT0822908	

*Requires (2) top hats to achieve 1/2" ID; order (2) of part number 41774 for each wheel ordered.

High Heat Glass Filled Nylon (HT)								
Wheel Diameter (Inches)	Tread Width (Inches)	Capacity (Lbs) (Rated for manual operation)	Hub Length (Inches)	Bore ID (Inches)	Bearing ID (Inches)			
4	2	800	2-3/16	1-3/16	3/4	HT0420112		
5	2	1000	2-3/16	1-3/16	3/4	HT0520112		
6	2	1200	2-3/16	1-3/16	3/4	HT0620112		
8	2	1400	2-3/16	1-3/16	3/4	HT0820112		

High temp Delrin bearing available, consult factory.

Heavy Duty Glass Filled Nylon (DT)								
Wheel Diameter (Inches)	Tread Width (Inches)	Capacity (Lbs) (Rated for manual operation)	Hub Length (Inches)	Bore ID (Inches)	Bearing ID (Inches)			
4	2	1000	2-3/16	1-3/16	3/4	DT0420112		
4	2	800	2-3/16	1-3/16	1/2		DT0422808*	DT0422908
5	2	1200	2-3/16	1-3/16	3/4	DT0520112		
5	2	1000	2-3/16	1-3/16	1/2		DT0522808*	DT0522908
6	2	1400	2-3/16	1-3/16	3/4	DT0620112		
6	2	1200	2-3/16	1-3/16	1/2		DT0622808*	DT0622908
8	2	1600	2-3/16	1-3/16	3/4	DT0820112		
8	2	1400	2-3/16	1-3/16	1/2		DT0822808*	DT0822908

*Requires (2) top hats to achieve 1/2" ID; order (2) of part number 41774 for each wheel ordered.

WHEEL OPTIONS

- Note: Select bearings featured are recommended for standard applications. For special applications or alternate bearings consult factory. See bearing information on page 13.
- For customization & special application options, please consult factory.
- For stainless steel roller bearing specify **ZB03**.



NG Economical Maxim® Glass Filled Nylon



Albion's Maxim® wheel delivers maximum performance and an economical solution for your most demanding caster applications. With a focus on ergonomics, this advanced wheel starts rolling, keeps rolling and swivels with ease! The innovative nylon and fiberglass construction stands up to solvents, extreme temperatures and high load capacities. Maxim wheels won't absorb moisture!

FEATURES

- **Wheel face:** Slight crown
- **Finish:** Black
- **Temperature Range:** -40° to +250°F
- **Hardness:** 85 Shore D ±5

WHEEL OPTIONS

- Note: Select bearings featured are recommended for standard applications. For special applications or alternate bearings consult factory. See bearing information on page 13
- For customization & special application options, please consult factory

Wheel Diameter (Inches)	Tread Width (Inches)	Capacity (Lbs) (Based for manual operation)	Hub Length (Inches)	Bore ID (Inches)	Bearing ID (Inches)	Approx. Wt. (Lbs)	Wheel Number	Roller Bearing (01,07)	Wheel Number Pedestal Precision Ball (29)*
3-1/4	2	700	2-3/16	1-3/16	3/4	1	NG0320112		
3-1/4	2	700	2-3/16	1-3/16	1/2	1			NG0322908
4	2	800	2-3/16	1-3/16	3/4	1	NG0420112		
4	2	800	2-3/16	1-3/16	1/2	1			NG0422908
5	2	1000	2-3/16	1-3/16	3/4	1	NG0520112		
5	2	1000	2-3/16	1-3/16	1/2	1			NG0522908
6	2	1200	2-3/16	1-3/16	3/4	1-1/8	NG0620112		
6	2	1200	2-3/16	1-3/16	1/2	1-1/8			NG0622908
8	2	1400	2-3/16	1-3/16	3/4	1-3/8	NG0820112		
8	2	1400	2-3/16	1-3/16	1/2	1-3/8			NG0822908
10	2-1/2	1500	2-3/4	1-3/16	3/4		NG1040712		

* Hub length of pedestal precision bearing (29) models is 2-7/16".

NW Premium Quality Economical White Nylon



Economical, Strong, Clean.
Excellent for clean rooms!

FEATURES

- **Wheel face:** Moderate crown
- Composed of injection molded white nylon
- Maximum performance, economical solution for your most demanding caster applications
- Excellent ergonomics ... wheel starts rolling, keeps rolling and swivels with ease
- **Temperature Range:** -20°F to 250°F
- **Hardness:** 85 Shore D ±5

WHEEL OPTIONS

- Note: Select bearings featured are recommended for standard applications. For special applications or alternate bearings consult factory. See bearing information on page 13
- For customization & special application options, please consult factory

Wheel Diameter (Inches)	Tread Width (Inches)	Capacity (Lbs) (Based for manual operation)	Hub Length (Inches)	Bore ID (Inches)	Bearing ID (Inches)	Approx. Weight (Lbs)	Bearing	Wheel Number
5	2	600	2-3/16	1-3/16	1-3/16	1	Plain Bore	NW0520019
5	2	600	2-3/16	1-3/16	3/4	1	Roller	NW0520112
5	2	600	2-3/16	1-3/16	1/2	1	Pedestal Precision Ball	NW0522908
5	2	600	2-3/16	1-3/16	3/4	1	Delrin	NW0525112
6	2	900	2-3/16	1-3/16	1-3/16	1-1/4	Plain Bore	NW0620019
6	2	900	2-3/16	1-3/16	3/4	1-1/4	Roller	NW0620112
6	2	900	2-3/16	1-3/16	1/2	1-1/4	Pedestal Precision Ball	NW0622908
6	2	900	2-3/16	1-3/16	3/4	1-1/4	Delrin	NW0625112
8	2	1100	2-3/16	1-3/16	1-3/16	2	Plain Bore	NW0820019
8	2	1100	2-3/16	1-3/16	3/4	2	Roller Bearing	NW0820112
8	2	1100	2-3/16	1-3/16	1/2	2	Pedestal Precision Ball	NW0822908
8	2	1100	2-3/16	1-3/16	3/4	2	Delrin	NW0825112



NX

 Premium Quality

 Maintenance Free

 Ergonomic

Trionix™ High Impact Polymer



These unique high impact polymer wheels deliver superior rollability, capacity and slide resistance. Trionix™ features unique polymers that resist corrosion and most chemicals. Wheels are machined and straight sided.

FEATURES

- **Wheel face:** Slight crown
- **Finish:** Black
- **Temperature Range:** -30°F to +220°F
- **Hardness:** 78-82 Shore D

WHEEL OPTIONS

- Note: Select bearings featured are recommended for standard applications. For special applications or alternate bearings consult factory. See bearing information on page 13
- For customization & special application options, please consult factory

Wheel Diameter (Inches)		Tread Width (Inches)	Capacity (Lbs) (Rated for normal operation)	Hub Length (Inches)	Bore ID (Inches)	Bearing ID (Inches)	Approx. Wt. (Lbs)	Wheel Number Precision Ball (28)
Trionix High Impact Polymer (NX)								
4	2	2160	2-7/16	2	1/2	4		NX0422808
5	2	2160	2-7/16	2	1/2	5		NX0522808
6	2	2160	2-7/16	2	1/2	6		NX0622808
6	2-1/2	7200	3	2	3/4	6-1/2		NX0642812
6	3	7200	3-1/2	2	3/4	6-1/2		NX0652812
8	2	2160	2-7/16	2	1/2	8		NX0822808
8	2-1/2	7200	3	2	3/4	9		NX0842812
8	3	7200	3-1/2	2	3/4	9		NX0852812
10	2-1/2	7200	3	2	3/4	10		NX1042812
10	3	7200	3-1/2	2	3/4	10		NX1052812

Note: For 6", 8" and 10" diameter wheels, use ZY1216003 top hats to increase all 2-1/2" wide wheels to 3-1/2" hub length.

NV

 Premium Quality

 Maintenance Free

Trionix™ High Impact Polymer V-Groove



Like the NX wheels, these unique high impact polymer wheels deliver superior rollability, capacity and slide resistance. Trionix™ features unique polymers that resist corrosion and most chemicals. Wheels are machined with V-groove.

FEATURES

- **Wheel face:** Slight crown
- **Finish:** Black
- **Temperature Range:** -30°F to +220°F
- **Hardness:** 78-82 Shore D

WHEEL OPTIONS

- Note: Select bearings featured are recommended for standard applications. For special applications or alternate bearings consult factory. See bearing information on page 13
- For customization & special application options, please consult factory

Wheel Diameter (Inches)		Tread Width (Inches)	Capacity (Lbs) (Rated for normal operation)	Hub Length (Inches)	Bore ID (Inches)	Groove Width "A" (Inches)	Groove Depth "B" (Inches)	Wheel Number Precision Ball (28)
Trionix V-Groove High Impact Polymer (NV)								
4	2	2160	2-7/16	1/2	.88	.44		NV0422808
5	2	2160	2-7/16	1/2	.88	.44		NV0522808
6	2	2160	2-7/16	1/2	.88	.44		NV0622808
8	2	2160	2-7/16	1/2	.88	.44		NV0622808

*Spanner held in place with snap rings to prevent loss of top hat.

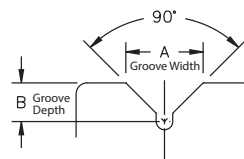

Letters match to chart descriptions

TH/TS



Economical

Straight Sided Phenolic



TH/TS wheels are molded of heavy macerated or chopped cotton denim, impregnated with phenolic resin and formed in close fitting molds under high pressure and temperature. They are non-marking and excellent load carriers.

FEATURES

- **Wheel face:** Moderate crown
- **Finish:** Black
- **Temperature Range:** -65°F to +250°F (+300°F intermittent)
- **Hardness:** Rockwell 102 E

WHEEL OPTIONS

- Note: Select bearings featured are recommended for standard applications. For special applications or alternate bearings consult factory. See bearing information on page 13
- For customization & special application options, please consult factory

	Wheel Diameter (Inches)	Tread Width (Inches)	Capacity (Lbs) (Based on manual operation)	Hub Length (Inches)	Bore ID (Inches)	Bearing ID (Inches)	Approx. Wt. (Lbs)	Wheel Number Roller Bearing (01)
Straight Sided Phenolic (TH, TS)								
4	1-1/2	500	1-27/32	1-1/16	3/4	3/4		TS0410112
4	1-7/8	800	2-13/32	1-3/16	3/4	1		TS0420112
4	2	1000	2-3/16	1-3/16	1/2	1-3/4		TH0420108
4	2	1000	2-3/16	1-3/16	5/8	1-3/4		TH0420110
4	2	1000	2-3/16	1-3/16	3/4	1-3/4		TH0420112~
5	1-1/2	500	1-27/32	1-1/16	3/4	1-1/4		TS0510112~
5	1-7/8	1000	2-13/32	1-3/16	3/4	1-1/2		TS0520112
5	2	1200	2-3/16	1-3/16	1/2	2-1/4		TH0520108
5	2	1200	2-3/16	1-3/16	5/8	2-1/4		TH0520110
5	2	1200	2-3/16	1-3/16	3/4	2-1/4		TH0520112~
6	1-1/2	500	1-27/32	1-3/16	3/4	1-1/4		TS0610112
6	1-7/8	1200	2-13/32	1-3/16	3/4	1-3/4		TS0620112
6	2	1500	2-3/16	1-3/16	1/2	3		TH0620108
6	2	1500	2-3/16	1-3/16	5/8	3		TH0620110
6	2	1500	2-3/16	1-3/16	3/4	3		TH0620112~
8	1-7/8	1400	2-13/32	1-3/16	3/4	4		TS0820112

~ Wheels are complete with spanner bushing and nylon sealed retaining/thrust washer.

TM



Economical

Phenolic



TM wheels are molded of heavy macerated or chopped cotton denim, impregnated with phenolic resin and formed in close fitting molds under high pressure and temperature. They are non-marking and excellent load carriers.

FEATURES

- **Wheel face:** Moderate crown
- **Finish:** Black
- **Temperature Range:** -65°F to +250°F (+300°F intermittent)
- **Hardness:** Rockwell 102 E

WHEEL OPTIONS

- Note: Select bearings featured are recommended for standard applications. For special applications or alternate bearings consult factory. See bearing information on page 13
- For customization & special application options, please consult factory

	Wheel Diameter (Inches)	Tread Width (Inches)	Capacity (Lbs) (Based on manual operation)	Hub Length (Inches)	Bore ID (Inches)	Bearing ID (Inches)	Approx. Wt. (Lbs)	Wheel Number Roller Bearing (01)	Wheel Number Tapered Roller (09)
Phenolic (TM)									
3	1-1/4	400	1-3/8	1-1/16	1/2	1/2		TM0300108	
3-1/4	1-1/2	600	1-5/8	1-3/16	1/2	3/4		TM0310108	
3-1/4	1-1/2	600	1-5/8	1-3/16	5/8	3/4		TM0310110	
3-1/4	1-1/2^A	600	1-5/8	1-3/16	3/4	3/4		TM0310112~	
3-1/4	2	700	2-3/16	1-3/16	1/2	1-1/4		TM0320108	
3-1/4	2	700	2-3/16	1-3/16	5/8	1-1/4		TM0320110	
3-1/4	2	700	2-3/16	1-3/16	3/4	1-1/4		TM0320112~	
3-1/2	1-1/4	400	1-3/8	1-1/16	1/2	3/4		TM03X0108	
4	1-1/4	400	1-3/8	1-1/16	1/2	3/4		TM0400108	
4	1-1/2	600	1-5/8	1-3/16	1/2	1		TM0410108	
4	1-1/2	600	1-5/8	1-3/16	5/8	1		TM0410110	
4	1-1/2^A	600	1-5/8	1-3/16	3/4	1		TM0410112~	
4	2	800	2-3/16	1-3/16	1/2	1-1/2		TM0420108	
4	2	800	2-3/16	1-3/16	5/8	1-1/2		TM0420110	
4	2	800	2-3/16	1-3/16	3/4	1-1/2		TM0420112~	
5	1-1/4	400	1-3/8	1-1/16	1/2	1-1/4		TM0500108	
5	1-1/2	600	1-5/8	1-3/16	1/2	1-1/2		TM0510108	
5	1-1/2	600	1-5/8	1-3/16	5/8	1-1/2		TM0510110	
5	1-1/2^A	600	1-5/8	1-3/16	3/4	1-1/2		TM0510112~	
5	2	1000	2-3/16	1-3/16	1/2	1-3/4		TM0520108	
5	2	1000	2-3/16	1-3/16	5/8	1-3/4		TM0520110	
5	2	1000	2-3/16	1-3/16	3/4	1-3/4		TM0520112~	
6	1-1/2	800	1-5/8	1-3/16	1/2	1-1/2		TM0610108	
6	1-1/2	800	1-5/8	1-3/16	5/8	1-1/2		TM0610110	
6	1-1/2^A	800	1-5/8	1-3/16	3/4	1-1/2		TM0610112~	
6	2	1200	2-3/16	1-3/16	1/2	2-1/2		TM0620108	
6	2	1200	2-3/16	1-3/16	5/8	2-1/2		TM0620110	

~ Wheels are complete with spanner bushing and nylon sealed retaining/thrust washer.

^ 2 7/16" spanner and spacers included.

**Specially machined wheel built from 2 modified 3" tread width wheels.

PHENOLIC WHEELS • UP TO 1500



Continued from previous page.

Phenolic



See previous page for TM description and product details.

TR Heat Resistant Phenolic



Similar to TM wheels, but the temperature range increases to up to +475°F continuous use or +525°F intermittent use for TR wheels. Color is reddish green. See TM wheel for features and options. To order TR wheels, change TM wheel number to **TR**. Example: **TR1040116**. Capacities are reduced – consult factory.

TL Laminated Phenolic



Consult factory for models and options

TL wheels feature a laminated tread that is highly resistant to chipping or fraying. Wheels are molded of heavy macerated or chopped cotton denim, impregnated with phenolic resin and formed in close fitting molds under high pressure and temperature. They are non-marking and excellent load carriers. Color is brown with black core. See TM wheel for features and options. To order TL wheels, change **TM** in wheel number to **TL**. Example: **TL1040116**.

Phenolic (TM)							Wheel Number Roller (01, 05, 07)	Wheel Number Tapered Roller (09)
Wheel Diameter (Inches)	Tread Width (Inches)	Capacity (Lbs) (Rated for manual operation)	Hub Length (Inches)	Bore ID (Inches)	Bearing ID (Inches)	Approx. Wt. (Lbs)		
6	2	1200	2-3/16	1-3/16	3/4	2-1/2	TM0620112~	
6	2-1/2	1600	3-1/4	1-15/16	1	4-1/2	TM0640116	
6	2-1/2	1600	3-1/4	1-15/16	1-1/4	4-1/2	TM0640120	
6	2-1/2	1600	2-3/4	1-15/16	1	4-1/4	TM0640516	
6	2-1/2	1600	2-3/4	1-3/16	3/4	3-1/2	TM0640712	
6	2-1/2	1600	3-1/2	1-15/16	3/4	4-1/4		TM0640912
6	3	2000	3-1/4	1-3/16	1	5	TM0650116	
6	3	2000	3-1/4	1-3/16	1-1/4	5	TM0650120	
6	3	2000	3-1/2	1-3/16	3/4	4-3/4		TM0650912
6	3	2000	3-1/2	1-3/16	1	4-3/4		TM0650916
6	3	2000	3-1/2	1-1/16	1-1/4	4-3/4		TM0650920
7	3	2200	3-1/4	1-15/16	1	6-1/2	TM0750116	
7	3	2200	3-1/4	1-15/16	1-1/4	6-1/2	TM0750120	
7	3	2200	3-1/2	1-15/16	3/4	6-1/4		TM0750912
7	3	2200	3-1/2	2	1	6-1/4		TM0750916
7	3	2200	3-1/2	2-11/32	1-1/4	6-1/4		TM0750920
8	2	1400	2-3/16	1-3/16	5/8	4	TM0820110	
8	2	1400	2-3/16	1-3/16	3/4	4	TM0820112~	
8	2-1/2	2000	3-1/4	1-15/16	1	6-1/4	TM0840116	
8	2-1/2	2000	3-1/4	1-15/16	1-1/4	6-1/4	TM0840120	
8	2-1/2	1800	2-3/4	1-15/16	1	5-3/4	TM0840516	
8	2-1/2	1600	2-3/4	1-3/16	3/4	5-1/4	TM0840712	
8	2-1/2	2000	3-1/2	1-15/16	3/4	6		TM0840912
8	2-1/2	2000	3-1/2	2	1	6		TM0840916
8	3	2500	3-1/4	1-15/16	1	7-1/4	TM0850116	
8	3	2500	3-1/4	1-15/16	1-1/4	7-1/4	TM0850120	
8	3	2500	3-1/2	1-15/16	3/4	7		TM0850912
8	3	2500	3-1/2	2	1	7		TM0850916
8	3	2500	3-1/2	2-11/32	1-1/4	7		TM0850920
8	6**	5000	6-1/2	2-11/32	1-1/4	15-1/2		TM0890920
10	2-1/2	2500	3-1/4	1-15/16	1	7-3/4	TM1040116	
10	2-1/2	2500	3-1/4	1-15/16	1-1/4	7-3/4	TM1040120	
10	2-1/2	2500	2-3/4	1-15/16	1	7-1/2	TM1040516	
10	2-1/2	2500	2-3/4	1-3/16	3/4	7	TM1040712	
10	3	2900	3-1/4	1-15/16	1	9-3/4	TM1050116	
10	3	2900	3-1/4	1-15/16	1-1/4	9-3/4	TM1050120	
10	3	2900	3-1/2	1-15/16	3/4	9-1/2		TM1050912
10	3	2900	3-1/2	2	1	9-1/2		TM1050916
10	3	2900	3-1/2	2-11/32	1-1/4	9-1/2		TM1050920
10	6**	5800	6-1/2	2-11/32	1-1/4	20-1/2		TM1090920
12	2-1/2	3000	3-1/4	1-15/16	1	11-3/4	TM1240116	
12	2-1/2	3000	3-1/4	1-15/16	1-1/4	11-3/4	TM1240120	
12	2-1/2	1800	2-3/4	1-15/16	1	11-1/4	TM1240516	
12	3	3500	3-1/4	1-15/16	1	12-3/4	TM1250116	
12	3	3500	3-1/4	1-15/16	1-1/4	12-3/4	TM1250120	
12	3	3500	3-1/2	1-15/16	3/4	12-1/2		TM1250912
12	3	3500	3-1/2	2	1	12-1/2		TM1250916
12	3	3500	3-1/2	2-11/32	1-1/4	12-1/2		TM1250920
12	3-1/2	4000	4-1/4	2-7/16	1-1/4	23-1/2	TM1260120	
12	3-1/2	4000	4-1/4	2-7/16	1-1/2	23-1/2	TM1260124	
12	3-1/2	4000	4-1/2	2-7/16	1	23		TM1260916
12	3-1/2	4000	4-1/2	2-7/16	1-1/4	23		TM1260920
12	4	8000	4-1/2	2-11/32	1-1/4	26-1/4		TM1270920
16	3	4000	4-1/4	2-7/16	1-1/4	25	TM1650120	
16	3	4000	4-1/4	2-7/16	1-1/2	25	TM1650124	
16	3	4000	4-1/2	2-7/16	1-1/4	25-3/4		TM1650920
16	4	8000	5-1/4	2-7/16	1-1/4	35-3/4	TM1670120	
16	4	8000	5-1/4	2-7/16	1-1/2	35-3/4	TM1670124	
16	4	8000	5-1/2	2-7/16	1-1/4	34-1/4		TM1670920
18	3	3500	3-1/4	1-15/16	1	23-3/4	TM1850116	
18	3	3500	3-1/4	1-15/16	1-1/4	23-3/4	TM1850120	

~ Wheels are complete with spanner bushing and nylon sealed retaining/thrust washer.

^ 2⁷/₁₆" spanner and spacers included.

**Specially machined wheel built from 2 modified 3" tread width wheels.

PB Economical Polypropylene



This wheel is an injection molded blend of thermo-plastic polymers which resist absorption and are resistant to most chemicals and solvents. Capacity ratings are comparable to hard rubber wheels with the added advantage of being lighter in weight and having greater impact resistance.

FEATURES

- **Wheel face:** Moderate crown
- **Finish:** Black
- **Temperature Range:** -20°F to +180°F
- **Hardness:** 65 Shore D

WHEEL OPTIONS

- Note: Select bearings featured are recommended for standard applications. For special applications or alternate bearings consult factory. See bearing information on page 13
- For customization & special application options, please consult factory

PW Economical White Polypropylene



Same options as PB



RW RETORT Polypropylene



Designed to withstand the rigors of high temperature, RW wheels are perfect for cooker racks and retort carts. The oversized bore ID ensures smooth movement, even if wheels experience heat expansion.

FEATURES

- **Wheel Face:** Moderate crown
- **Finish:** White
- **Temperature Range:** -20°F degrees up to +290°F
- **Hardness:** 75 Shore D
- Same options as PB

Polypropylene (PB)										Wheel Number Delrin Bearing (51)	Wheel Number Plain Bore (41)
Wheel Diameter (Inches)	Tread Width (Inches)	Capacity (Lbs) (Based for manual operation)	Hub Length (Inches)	Bore ID (Inches)	Bearing ID (Inches)	Approx. Wt. (Lbs)	Wheel Number Roller Bearing (01)				
3	1-3/8	250	1-1/2	1-5/16	1/2	1/2				PB0305108	
3	1-1/4	250	1-1/2	1/2	1/2	1/2					PB0304108
3-1/2	1-3/8	275	1-1/2	1-5/16	1/2	1/2				PB03X5108	
4	1-1/4	300	1-1/2	1/2	1/2	1/2					PB0404108
4	1-3/8	300	1-1/2	1-5/16	1/2	1/2				PB0405108	
4	1-1/2 [^]	400	1-5/8	1-3/16	1/2	3/4			PB0410112~		
4	2	450	2-3/16	3/4	3/4	1/2			PB0420112~		PB0424112
4	2	450	2-3/16	1-3/16	3/4	1					
5	1-1/4	450	1-1/2	1/2	1/2	1/2					PB0504108
5	1-1/4	450	1-1/2	1-5/16	1/2	1/2				PB0505108	
5	1-1/2 [^]	450	1-5/8	1-3/16	3/4	1			PB0510112~		
5	2	550	2-3/16	3/4	3/4	3/4			PB0520112~		PB0524112
5	2	650	2-3/16	1-3/16	3/4	1-1/4					
6	1-1/2 [^]	550	1-5/8	1-3/16	3/4	1			PB0610112~		
6	2	650	2-3/16	3/4	3/4	1					PB0624112
6	2	750	2-3/16	1-3/16	3/4	1-1/2			PB0620112~		
8	2	850	2-3/16	3/4	3/4	1-1/4					PB0824112
8	2	1000	2-3/16	1-3/16	3/4	1-3/4			PB0820112~		

~ Wheels are complete with spanner bushing & nylon retaining thrust washers.
[^] 27/16" spanner and spacers included.

White Polypropylene (PW)										Wheel Number Plain Bore (41)	Wheel Number Delrin Bearing (51)*
Wheel Diameter (Inches)	Tread Width (Inches)	Capacity (Lbs) (Based for manual operation)	Hub Length (Inches)	Bore ID (Inches)	Bearing ID (Inches)	Approx. Wt. (Lbs)	Wheel Number Roller Bearing (01)				
3	1-1/4	250	1-7/16	1/2	1/2	1/2				PW0304108	
3-1/2	1-1/4	275	1-7/16	1/2	1/2	1/2				PW03X4108	
4	1-1/4	300	1-7/16	1/2	1/2	1/2				PW0404108	
4	1-1/2	400	1-5/8	3/4	3/4	1/2				PW0414112	
4	2	450	2-3/16	3/4	3/4	3/4				PW0424112	
4	2	450	2-3/16	1/2	1/2	3/4				PW0424108	
5	1-1/4	450	1-7/16	1/2	1/2	1/2				PW0504108	
5	1-1/2	450	1-5/8	3/4	3/4	1/2				PW0514112	
5	2	550	2-3/16	3/4	3/4	3/4				PW0524112	
5	2	650	2-3/16	1/2	1/2	3/4				PW0524108	
5	2	650	2-3/8	1/2	3/4	3/4					PW0525112
6	1-1/2	550	1-5/8	3/4	3/4	3/4				PW0614112	
6	2	650	2-3/16	3/4	3/4	3/4				PW0624112	
6	2	750	2-3/16	1/2	1/2	3/4				PW0624108	
6	2	750	2-3/8	1/2	3/4	3/4					PW0625112

* Hub length of Delrin bearing (51) models is 2-9/16".

RETORT Polypropylene (RW)										Wheel Number Roller Bearing (01)	Wheel Number Plain Bore (41)
Wheel Diameter (Inches)	Tread Width (Inches)	Capacity (Lbs) (Based for manual operation)	Hub Length (Inches)	Bore ID (Inches)	Bearing ID (Inches)	Approx. Wt. (Lbs)	Wheel Number Roller Bearing (01)				
3	1-3/8	300	1-1/2	1/2	1/2	1/4					RW0304108
3-1/2	1-3/8	300	1-1/2	1/2	1/2	1/4					RW03X4108
4	1-3/8	300	1-1/2	1/2	1/2	3/4					RW0404108
4	1-1/2 [^]	375	1-5/8	1-3/16	3/4	1			RW0410112		
4	2	500	2-3/16	1-3/16	3/4	1			RW0420112		
5	1-3/8	440	1-1/2	1/2	1/2	1					RW0504108
5	1-1/2 [^]	540	1-5/8	1-3/16	3/4	1			RW0510112		
5	2	650	2-3/16	1-3/16	3/4	1/2			RW0520112		
6	1-1/2 [^]	600	1-5/8	1-3/16	3/4	1/2			RW0610112		
6	2	700	2-3/16	1-3/16	3/4	2			RW0620112		
8	1-1/2 [^]	750	1-5/8	1-3/16	3/4	2			RW0810112		
8	2	900	2-3/16	1-3/16	3/4	2-1/2			RW0820112		



[^] 27/16" spanner and spacers included.

POLYURETHANE TREAD WHEELS





Vulkollan® Wheels

-  Vulkollan® Premium Polyurethane (VY, VX)...148-150



Polyurethane on Iron Wheels

-  Polyurethane on Iron (PY, PH, PI).....151-152, 154
-  Polyurethane on Iron (Thick Tread) (PX).....153
-  Polyurethane on Heavy Duty Cast Iron (PF).....154



Polyurethane on Aluminum Wheels

-  Polyurethane on Aluminum (PA, PD).....155
-  Polyurethane Round Tread on Aluminum (PM, PM 80A).....156
-  Polyurethane Round Tread on Aluminum (AX).....156
-  Magnum Round Tread Polyurethane on Aluminum (UA).....157



Polyurethane Solid Elastomer Wheels

-  Polyurethane X-treme® Plus (XP).....159-160
-  Polyurethane X-treme® (XI).....159-160
-  Polyurethane Solid Elastomer (SE).....161



Polyurethane on Polypropylene Wheels

-  Polyurethane on Polypropylene (XA)161
-  Eagle Polyurethane on Polypropylene (EG).....162

Polyurethane Specialty Wheels

-  Polyurethane Reactive (PR).....155
-  Polyurethane Swivel-EAZ® (EY, EZ).....158
-  Polyurethane V-Groove (XV).....165

Polyurethane Press-On Wheels

-  Polyurethane Press-On (OG).....163-165
-  Polyurethane Press-On Mini (OG).....165

POLYURETHANE EXPERTS



- Strong tread bond for long life
- Close tolerance cores for precise manufacturing and quality control
- Superior material blends for the highest quality treads

ALBION
the caster experts

Albiion offers an expansive range of polyurethane wheels, with various material blends designed to deliver specific features and application benefits (see pages 146-165 for full offering)

Our popular **80A** and **95A** durometer wheels are **designed and proven for industrial use**—many offering a **3 year warranty**

New formulas and tread profiles continue to be developed to **enhance ergonomics (AX, PF, and UA wheels)**

Standard and custom keyway inserts are available

Custom machining and crown facing

Cutter bars, brakes, and sound dampening pads available

Custom colors available (minimums may apply)

Specialty Wheel Development – Albiion’s team of engineers has significant experience designing and developing new wheels for specialty applications in virtually any industry. Contact factory with your needs!

Anti-Microbial Additives – Bacterial inhibitors are available in many of our urethane products. If your food, medical, or laboratory application requires additional peace of mind, this is a great wheel solution.

PREVENZ™ ANTIMICROBIAL*

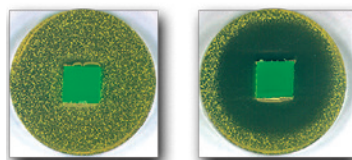

*Please contact factory for ordering information.

VULKOLLAN® WHEELS (VY/VX)

- **Highest quality** polyurethane in the world
- **Superior** in load capacity, reliability, strength, and life
- **Reduce** your downtime and maintenance costs with Vulkollan!

Tear Resistance

Standard Polyurethane vs. Vulkollan® Polyurethane Is Much Harder to Tear

Product Life

Standard Polyurethane vs. Vulkollan® Polyurethane Last up to 40% Longer!

See next page for more details



VULKOLLAN®

THE ULTIMATE ELASTOMER



We are one of the very few companies licensed to produce Vulkollan Polyurethane Raw Materials.

Now the highest quality polyurethane in the world is available from the highest quality caster company in the world. Beware of imitators; competitors will produce knockoff wheels that look like Vulkollan®, but do not match its performance. Albion guarantees authentic Vulkollan®. If you are looking for unmatched performance and legendary durability, look to Albion – your source for the best polyurethane wheels in the world.

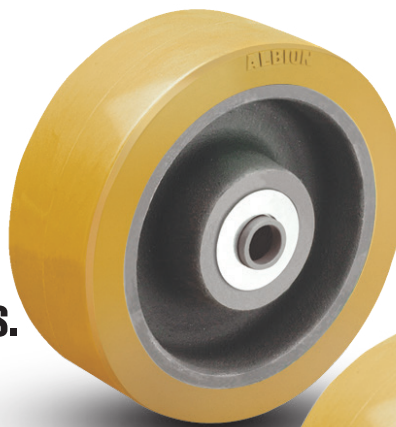

Thick Tread VX

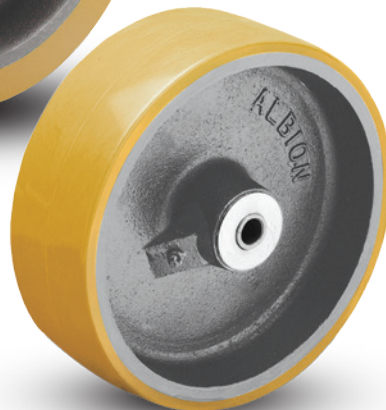

Standard Tread VY

FEATURES

The Vulkollan® raw materials are superior and the processes take longer, but as you can see from the features, some things are worth waiting for:

- Superior tear resistance
- Superior rebound resilience
- Superior ozone, grease and oils resistance
- Superior dynamic load capacity
- Superior reliability
- Superior wear resistance
- Superior structural strength
- Low permanent deformation
- Reduced downtime and maintenance costs
- Bottom line: wheel may last 40% longer than most polyurethane wheels especially in extreme conditions

Capacity

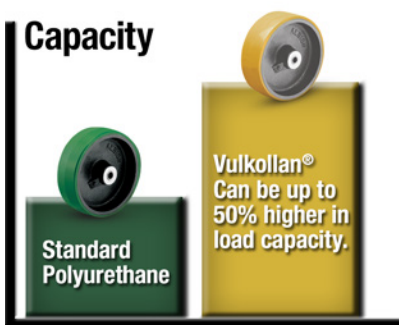

Product Life



Tear Resistance



APPLICATIONS



VY



Ergonomic



Premium Quality



Towing[^]

Vulkollan[®]

on Cast Iron

Made in the USA



Vulkollan are the highest quality polyurethane wheels with unmatched performance and durability.

FEATURES

- **Thickness:** 1/2" thick polyurethane tread
- **Wheel Face:** Tapered 3° Crown
- **Finish:** Orange/Brown tread on cast iron core
- **Hardness:** 95 Shore A
- **Temperature Range:** -40°F to +180°F

WHEEL OPTIONS

- Note: Select bearings featured are recommended for standard applications. For special applications or alternate bearings consult factory. See bearing information on page 13
- For customization & special application options, please consult factory

Note: Vulkollan is a registered trademark of Bayer MaterialScience

Vulkollan Value Quotient:

- Highest Quality Polyurethane in the World
- Extremely Durable
- High Load Capacity
- Ergonomic - Easy to Roll
- High Abrasion Resistance



Depending on diameter and tread width, cores may be spoked, solid

Wheel Diameter (Inches)	Tread Width (Inches)	Capacity (Lbs) (Based on manual operation)	Hub Length (Inches)	Bore ID (Inches)	Bearing ID (Inches)	Approx. Wt. (Lbs)	Wheel Number Roller Bearing (01,05)	Wheel Number Tapered Bearing (09)	Wheel Number Precision Ball (28)
-------------------------	----------------------	--	---------------------	------------------	---------------------	-------------------	-------------------------------------	-----------------------------------	----------------------------------

Vulkollan on Cast Iron

4	2	1100	2-3/16	1-3/16	1/2	5	VY0420112		
5	2	1400	2-3/16	1-3/16	1/2	6			VY0522808
5	2	1400	2-3/16	1-3/16	3/4	6	VY0520112		
6	2	1500	2-3/16	1-3/16	1/2	8			VY0622808
6	2	1500	2-3/16	1-3/16	3/4	8	VY0620112		
6	2-1/2	2350	3-1/4	1-15/16	1	10-1/2	VY0640116		
6	2-1/2	2350	3-1/4	1-15/16	1-1/4	10-1/2	VY0640120		
6	2-1/2	2350	2-3/4	1-15/16	1	11	VY0640516		
6	3	3000	3-1/2	2.04	3/4	13-3/4			VY0652812
6	3	3000	3-1/4	1-15/16	1	13-3/4	VY0650116		
6	3	3000	3-1/4	1-15/16	1-1/4	13-3/4	VY0650120		
6	3	3000	3-1/2	1-15/16	3/4	13-1/4		VY0650912	
6	3	3000	3-1/2	1.98	1	13-1/4		VY0650916	
8	2	2000	2-3/16	1-3/16	1/2	9			VY0822808
8	2	2000	2-3/16	1-3/16	3/4	9	VY0820112		
8	2-1/2	2900	3-1/4	1-15/16	1	13	VY0840116		
8	2-1/2	2900	3-1/4	1-15/16	1-1/4	13	VY0840120		
8	2-1/2	2900	2-3/4	1-15/16	1	13	VY0840516		
8	3	4000	3-1/2	2.04	3/4	16			VY0852812
8	3	4000	3-1/2	2-7/16	25mm	16			VY0852816
8	3	4000	3-1/4	1-15/16	1	16	VY0850116		
8	3	4000	3-1/4	1-15/16	1-1/4	16	VY0850120		
8	3	4000	3-1/2	1-15/16	3/4	15-3/4		VY0850912	
8	3	4000	3-1/2	1.98	1	15-3/4		VY0850916	
8	3	4000	3-1/2	2.33	1-1/4	15-3/4		VY0850920	
8	4	5050	4-1/4	2-7/16	1-1/4	23-3/4	VY0870120		
8	4	5050	4-1/2	2-7/16	1	22-1/2		VY0870916	
8	4	5050	4-1/2	2-7/16	1-1/4	22-1/2		VY0870920	
10	2-1/2	3450	3-1/4	1-15/16	1	17-1/4	VY1040116		
10	2-1/2	3450	3-1/4	1-15/16	1-1/4	17-1/4	VY1040120		
10	2-1/2	3450	2-3/4	1-15/16	1	17-1/2	VY1040516		
10	3	5000	3-1/2	2.04	3/4	20-1/2			VY1052812
10	3	5000	3-1/2	2-7/16	25mm	20-1/2			VY1052816
10	3	5000	3-1/4	1-15/16	1	20-1/2	VY1050116		
10	3	5000	3-1/4	1-15/16	1-1/4	20-1/2	VY1050120		
10	3	5000	3-1/2	1-15/16	3/4	20		VY1050912	
10	3	5000	3-1/2	1.98	1	20		VY1050916	
10	3	5000	3-1/2	2.33	1-1/4	20		VY1050920	
10	4	6050	4-1/4	2-7/16	1-1/4	30-1/4	VY1070120		
10	4	6050	4-1/2	2-7/16	1	29		VY1070916	
10	4	6050	4-1/2	2-7/16	1-1/4	29		VY1070920	
12	3	5300	3-1/4	1-15/16	1	28-1/4	VY1250116		
12	3	5300	3-1/4	1-15/16	1-1/4	28-1/4	VY1250120		
12	3	5300	3-1/2	1-15/16	3/4	28		VY1250912	
12	3	5300	3-1/2	1.98	1	28		VY1250916	
12	3	5300	3-1/2	2.33	1-1/4	28		VY1250920	
12	4	6925	4-1/4	2-7/16	1-1/4	36-3/4	VY1270120		
12	4	6925	4-1/2	2-7/16	1	35-1/2		VY1270916	
12	4	6925	4-1/2	2-7/16	1-1/4	35-1/2		VY1270920	

IMPORTANT: The color of Vulkollan will change over time and exposure to UV rays from an off-white to a very dark brown.

[^]Towing: Consult factory prior to ordering to ensure selection supports your towing requirement



Thick Tread Vulkollan® on Cast Iron

Made in the USA



Vulkollan are the highest quality polyurethane wheels with unmatched performance and durability.

FEATURES

- **Thickness:** 1" thick polyurethane tread
- **Wheel Face:** Flat
- **Finish:** Orange/Brown tread on cast iron core
- **Hardness:** 95 Shore A
- **Temperature Range:** -40°F to +180°F

WHEEL OPTIONS

- Note: Select bearings featured are recommended for standard applications. For special applications or alternate bearings consult factory. See bearing information on page 13
- For customization & special application options, please consult factory

Note: Vulkollan is a registered trademark of Bayer MaterialScience

Vulkollan Value Quotient:

- Highest Quality Polyurethane in the World
- Extremely Durable
- High Load Capacity
- Ergonomic - Easy to Roll
- High Abrasion Resistance

Wheel Diameter (Inches)	Tread Width (Inches)	Capacity (Lbs) (Based on manual operation)	Hub Length (Inches)	Bore ID (Inches)	Bearing ID (Inches)	Approx. Wt. (Lbs)	Wheel Number Roller Bearing (01,05)	Wheel Number Tapered Bearing (09)	Wheel Number Precision Ball (28) Pedestal Precision Ball (29)
Thick Tread Vulkollan on Cast Iron									
6	2-1/2	2350	3-1/4	1-15/16	1	10-1/2	VX0640116		
6	2-1/2	2350	3-1/4	1-15/16	1-1/4	10-1/2	VX0640120		
6	2-1/2	2350	2-3/4	1-15/16	1	11	VX0640516		
6	3	3000	3-1/2	2.04	3/4	13-3/4			VX0652812
6	3	3000	3-1/2	2.04	3/4	13-3/4			VX0652912
6	3	3000	3-1/4	1-15/16	1	13-3/4	VX0650116		
6	3	3000	3-1/4	1-15/16	1-1/4	13-3/4	VX0650120		
6	3	3000	3-1/2	1-15/16	3/4	13-1/4		VX0650912	
6	3	3000	3-1/2	1.98	1	13-1/4		VX0650916	
8	2-1/2	2900	3-1/4	1-15/16	1	13	VX0840116		
8	2-1/2	2900	3-1/4	1-15/16	1-1/4	13	VX0840120		
8	2-1/2	2900	2-3/4	1-15/16	1	13	VX0840516		
8	3	4000	3-1/2	2.04	3/4	16			VX0852812
8	3	4000	3-1/2	2.04	3/4	16			VX0852912
8	3	4000	3-1/4	1-15/16	1	16	VX0850116		
8	3	4000	3-1/4	1-15/16	1-1/4	16	VX0850120		
8	3	4000	3-1/2	1-15/16	3/4	15-3/4		VX0850912	
8	3	4000	3-1/2	1.98	1	15-3/4		VX0850916	
8	3	4000	3-1/2	2.33	1-1/4	15-3/4		VX0850920	
10	2-1/2	3450	3-1/4	1-15/16	1	17-1/4	VX1040116		
10	2-1/2	3450	3-1/4	1-15/16	1-1/4	17-1/4	VX1040120		
10	2-1/2	3450	2-3/4	1-15/16	1	17-1/2	VX1040516		
10	3	5000	3-1/2	2.04	3/4	20-1/2			VX1052812
10	3	5000	3-1/2	2.04	3/4	20-1/2			VX1052912
10	3	5000	3-1/4	1-15/16	1	20-1/2	VX1050116		
10	3	5000	3-1/4	1-15/16	1-1/4	20-1/2	VX1050120		
10	3	5000	3-1/2	1-15/16	3/4	20		VX1050912	
10	3	5000	3-1/2	1.98	1	20		VX1050916	
10	3	5000	3-1/2	2.33	1-1/4	20		VX1050920	

IMPORTANT: The color of Vulkollan will change over time and exposure to UV rays from an off-white to a very dark brown.

PY/PH



Polyurethane on Cast Iron Core



These wheels are composed of a polyurethane elastomer, open cast on clean, close tolerance cores. Polyurethane tread is chemically bonded to a cast iron core. High capacity polyurethane protects floors, is non-marking and delivers quieter operation than standard metal wheels.

FEATURES

- **Thickness:** 1/2" thick polyurethane tread
- **Wheel Face:** Available in flat or 3° crown
- **Hardness:** 95 Shore A
- **Finish:** Green tread on black core
- **Temperature Range:** -40°F to +180°F

WHEEL OPTIONS

- **80 Shore A** durometer option available (20% capacity reduction) Red-orange tread on light grey core
- **70 Shore D** durometer option available (20% capacity increase) Black tread on black core
- Note: Select bearings featured are recommended for standard applications. For special applications or alternate bearings consult factory. See bearing information on page 13
- For customization & special application options, please consult factory
- Tapered bearings or precision ball bearings are recommended for towing applications

Depending on size, cores may be spoked or solid.

70 Shore D Models

Capacity increases 20% for 70 Shore D durometer models (To order, add 70D to end of wheel number)



Ergonomic Option 80 Shore A Models

Capacity decreases 20% for 80 Shore A durometer models (To order, add 80A to end of wheel number)

Wheel Diameter (Inches)	Tread Width (Inches)	95A Capacity (Lbs) (Rated for normal operation)	80A Capacity (Lbs) (Rated for normal operation)	70D Capacity (Lbs) (Rated for normal operation)	Hub Length (Inches)	Bore ID (Inches)	Bearing ID (Inches)	Approx. Wk. (Lbs)	Wheel Num. Roller Brg. (01,05,07)	Wheel Number Tapered Bearing (09)	Wheel Number Precision Ball (28)
-----------------------------------	--------------------------------	---	---	---	-------------------------------	----------------------------	-------------------------------	-----------------------------	---	---	--



Polyurethane on Cast Iron Core (PY, PH)											
3-1/4	1-5/8	420	330	500	1-5/8	1-3/16	1/2	1	PY0310108		
3-1/4	1-5/8	420	330	500	1-5/8	1-3/16	5/8	1	PY0310110		
3-1/4	1-5/8	420	330	500	1-5/8	1-3/16	3/4	1	PY0310112		
3-1/4	2-3/16	540	430	640	2-3/16	1-3/16	1/2	1-1/4	PY0320108		
3-1/4	2-3/16	540	430	640	2-3/16	1-3/16	5/8	1-1/4	PY0320110		
3-1/4	2-3/16	540	430	640	2-3/16	1-3/16	3/4	1-1/4	PY0320112		
3-1/4	3-1/4	850	680	1020	3-1/4	1-15/16	1	3	PY0350116		
3-1/4	3-1/4	850	680	1020	3-1/4	1-15/16	1-1/4	3	PY0350120		
3-1/4	4-1/4	1100	880	1320	4-1/4	1-15/16	1	3-3/4	PY0370116		
3-1/4	4-1/4	1100	880	1320	4-1/4	1-15/16	1-1/4	3-3/4	PY0370120		
3-1/4	4-1/4	1100	880	1320	4-1/2	1-15/16	3/4	3-3/4		PY0370912	
4	2	750	600	900	2-3/16	1-3/16	1/2		PY0420112		
5	2	1050	840	1250	2-3/16	1-3/16	1/2		PY0520112		
5	2-1/2	1300	1050	1500	2-3/4	1-15/16	1	8	PY0540516		PY0522808~
5	2-1/2	1300	1050	1500	3-1/4	1-15/16	1	8-1/2	PY0540116		
5	2-1/2	1300	1050	1500	3-1/4	1-15/16	1-1/4	8-1/2	PY0540120		
5	3	1500	1220	1750	3-1/4	1-15/16	1	9	PY0550116		
5	3	1500	1220	1750	3-1/4	1-15/16	1-1/4	9	PY0550120		
5	3	1500	1220	1750	3-1/2	1-15/16	3/4	8-1/2		PY0550912	
6	2	1200	960	1440	2-3/16	1-3/16	1/2		PY0620112		PY0622808~^
6	1-1/2	840	670	1000	1-5/8	1-3/16	1/2	4	PY0610108		
6	1-1/2	840	670	1000	1-5/8	1-3/16	5/8	4	PY0610110		
6	1-1/2	840	670	1000	1-5/8	1-3/16	3/4	4	PY0610112		
6	2	1200	960	1440	2-3/16	1-7/16	7/8	6	PH0620114		
6	2	1200	960	1440	2-3/16	1-7/16	1	6	PH0620116		
6	2-1/2	1600	1300	1900	2-3/4	1-3/16	3/4	6-3/4	PY0640712		
6	2-1/2	1600	1300	1900	2-3/4	1-15/16	1	11	PY0640516		
6	2-1/2	1600	1300	1900	3-1/4	1-15/16	1	10-1/2	PY0640116		
6	2-1/2	1600	1300	1900	3-1/4	1-15/16	1-1/4	10-1/2	PY0640120		
6	2-1/2	1600	1300	1900	3-1/2	1-15/16	3/4	10-1/2		PY0640912	
6	3	2000	1600	2350	3-1/4	1-15/16	1	13-3/4	PY0650116		
6	3	2000	1600	2350	3-1/4	1-15/16	1-1/4	13-3/4	PY0650120		
6	3	2000	1600	2350	3-1/2	1-15/16	3/4	13-1/4		PY0650912	
6	3	2000	1600	2350	3-1/2	1.98	1	13-1/4		PY0650916	
8	2	1500	1200	1750	2-3/16	1-3/16	1/2		PY0820112		
8	2-1/2	2000	1600	2400	3-1/4	1-15/16	1	13	PY0840116		PY0822808~
8	2-1/2	2000	1600	2400	3-1/4	1-15/16	1-1/4	13	PY0840120		
8	2-1/2	2000	1600	2400	2-3/4	1-15/16	1	13	PY0840516		
8	2-1/2	2000	1600	2400	2-3/4	1-3/16	3/4	9-3/4	PY0840712		
8	2-1/2	2000	1600	2400	3-1/2	1-15/16	3/4	12-3/4		PY0840912	
8	3	2500	2000	3000	3-1/4	1-15/16	1	16	PY0850116		
8	3	2500	2000	3000	3-1/4	1-15/16	1-1/4	16	PY0850120		
8	3	2500	2000	3000	3-1/2	1-15/16	3/4	15-3/4		PY0850912	
8	3	2500	2000	3000	3-1/2	1.98	1	15-3/4		PY0850916	
8	3	2500	2000	3000	3-1/2	2.33	1-1/4	15-3/4		PY0850920	
8	3	2500	2000	3000	3-1/4	2-7/16	1-1/4	15-1/2	PH0850120		
8	3	2500	2000	3000	3-1/4	2-7/16	1-1/2	15-1/2	PH0850124		
8	4	3800	3000	4300	4-1/4	2-7/16	1-1/4	23-3/4	PY0870120		
8	4	3800	3000	4300	4-1/4	2-7/16	1-1/2	23-3/4	PY0870124		
8	4	3800	3000	4300	4-1/2	2-7/16	1	22-1/2		PY0870916	
8	4	3800	3000	4300	4-1/2	2-7/16	1-1/4	22-1/2		PY0870920	
10	2-1/2	2300	1840	2760	3-1/4	1-15/16	1	17-1/4	PY1040116		
10	2-1/2	2300	1840	2760	3-1/4	1-15/16	1-1/4	17-1/4	PY1040120		
10	2-1/2	2300	1840	2760	2-3/4	1-15/16	1	17-1/2	PY1040516		
10	3	3000	2400	3600	3-1/4	1-15/16	1	20-1/2	PY1050116		
10	3	3000	2400	3600	3-1/4	1-15/16	1-1/4	20-1/2	PY1050120		
10	3	3000	2400	3600	3-1/2	1-15/16	3/4	20		PY1050912	

~ Pedestal Precision Ball (29) bearings also available. To order change "28" to "29". Example: PY0522908

^ Bearing ID is 3/4" for these models with Precision Ball bearings

^Towing: Consult factory prior to ordering to ensure selection supports your towing requirement

PY/PH

PY/PH Continued



See previous page for PY/PH description and product details.



Depending on diameter and tread width, cores may be spoked, solid spoked or solid.

Wheel Diameter (Inches)	Tread Width (Inches)	95A Capacity (Lbs) (Rated for manual operation)	80A Capacity (Lbs) (Rated for manual operation)	70D Capacity (Lbs) (Rated for manual operation)	Hub Length (Inches)	Bore ID (Inches)	Bearing ID (Inches)	Approx. Wt. (Lbs)	Wheel Num. Roller Brg. (01,05,07)	Wheel Number Tapered Bearing (09)	Wheel Number Precision Ball (28)
-----------------------------------	--------------------------------	---	---	---	-------------------------------	----------------------------	-------------------------------	-----------------------------	---	---	--

Polyurethane on Cast Iron Core (PY, PH)

Diameter (in)	Tread Width (in)	95A Capacity (Lbs)	80A Capacity (Lbs)	70D Capacity (Lbs)	Hub Length (in)	Bore ID (in)	Bearing ID (in)	Approx. Wt. (Lbs)	Wheel Num. Roller Brg.	Wheel Number Tapered Bearing	Wheel Number Precision Ball
10	3	3000	2400	3600	3-1/2	1.98	1	20		PY1050916	
10	3	3000	2400	3600	3-1/2	2.33	1-1/4	20		PY1050920	PY1052812~^
10	3	3000	2400	3600	3-1/4	2-7/16	1-1/4	19-3/4	PH1050120		
10	3	3000	2400	3600	3-1/4	2-7/16	1-1/2	19-3/4	PH1050124		
10	4	4200	3350	5000	4-1/4	2-7/16	1-1/4	30-1/4	PY1070120		
10	4	4200	3350	5000	4-1/4	2-7/16	1-1/2	30-1/4	PY1070124		
10	4	4200	3350	5000	4-1/2	2-7/16	1	29		PY1070916	
10	4	4200	3350	5000	4-1/2	2-7/16	1-1/4	29		PY1070920	
10	5	5000	4000	6000	5-1/4	2-7/16	1-1/4	41-1/4	PY1080120		
10	5	5000	4000	6000	5-1/4	2-7/16	1-1/2	41-1/4	PY1080124		
10	5	5000	4000	6000	5-1/2	2-7/16	1	39-1/4		PY1080916	
10	5	5000	4000	6000	5-1/2	2-7/16	1-1/4	39-1/4		PY1080920	
12	2-1/2	2700	2160	3240	3-1/4	1-15/16	1	22-3/4	PY1240116		
12	2-1/2	2700	2160	3240	3-1/4	1-15/16	1-1/4	22-3/4	PY1240120		
12	2-1/2	2700	2160	3240	2-3/4	1-15/16	1	22	PY1240516		
12	3	3500	2800	4200	3-1/4	1-15/16	1	28-1/4	PY1250116		
12	3	3500	2800	4200	3-1/4	1-15/16	1-1/4	28-1/4	PY1250120		
12	3	3500	2800	4200	3-1/2	1-15/16	3/4	28		PY1250912	
12	3	3500	2800	4200	3-1/2	1.98	1	28		PY1250916	
12	3	3500	2800	4200	3-1/2	2.33	1-1/4	28		PY1250920	
12	3	3500	2800	4200	3-1/4	2-7/16	1-1/4	27-1/2	PH1250120		
12	3	3500	2800	4200	3-1/4	2-7/16	1-1/2	27-1/2	PH1250124		
12	3-1/2	4110	3280	4900	4-1/4	2-7/16	1-1/4	31-1/2	PY1260120		
12	3-1/2	4110	3280	4900	4-1/4	2-7/16	1-1/2	31-1/2	PY1260124		
12	3-1/2	4110	3280	4900	4-1/2	2-7/16	1	30-1/2		PY1260916	
12	3-1/2	4110	3280	4900	4-1/2	2-7/16	1-1/4	30-1/2		PY1260920	
12	4	4800	3840	5760	4-1/4	2-7/16	1-1/4	36-3/4	PY1270120		
12	4	4800	3840	5760	4-1/4	2-7/16	1-1/2	36-3/4	PY1270124		
12	4	4800	3840	5760	4-1/2	2-7/16	1	35-1/2		PY1270916	
12	4	4800	3840	5760	4-1/2	2-7/16	1-1/4	35-1/2		PY1270920	
12	5	6000	4800	7200	5-1/4	2-7/16	1-1/4	48	PY1280120		
12	5	6000	4800	7200	5-1/4	2-7/16	1-1/2	48	PY1280124		
12	5	6000	4800	7200	5-1/2	2-7/16	1	47		PY1280916	
12	5	6000	4800	7200	5-1/2	2-7/16	1-1/4	47		PY1280920	
14	4	5000	4000	6000	4-1/4	2-7/16	1-1/4	48-1/2	PY1470120		
14	4	5000	4000	6000	4-1/4	2-7/16	1-1/2	48-1/2	PY1470124		
14	4	5000	4000	6000	4-1/2	2-7/16	1	47-1/2		PY1470916	
14	4	5000	4000	6000	4-1/2	2-7/16	1-1/4	47-1/2		PY1470920	
16	3	4260	3400	5100	4-1/4	2-7/16	1-1/4	51	PY1650120		
16	3	4260	3400	5100	4-1/4	2-7/16	1-1/2	51	PY1650124		
16	3	4260	3400	5100	4-1/2	2-7/16	1	49-3/4		PY1650916	
16	3	4260	3400	5100	4-1/2	2-7/16	1-1/4	49-3/4		PY1650920	
16	4	5970	4770	7160	5-1/4	2-7/16	1-1/4	65	PY1670120		
16	4	5970	4770	7160	5-1/4	2-7/16	1-1/2	65	PY1670124		
16	4	5970	4770	7160	5-1/4	3-1/16	1-3/4	65	PY1670128		
16	4	5970	4770	7160	5-1/2	2-7/16	1-1/4	63		PY1670920	
16	5	7700	6160	9240	5-1/4	2-7/16	1-1/4	100	PY1680120		
16	5	7700	6160	9240	5-1/4	2-7/16	1-1/2	100	PY1680124		
16	5	7700	6160	9240	5-1/4	3-1/16	1-3/4	100	PY1680128		
16	5	7700	6160	9240	5-1/4	3-1/4	2	100	PY1680132		
16	5	7700	6160	9240	5-1/2	2-7/16	1-1/4	100		PY1680920	
18	3	4600	3680	5520	4-1/4	2-7/16	1-1/4	59	PY1850120		
18	3	4600	3680	5520	4-1/4		1-1/2	59	PY1850124		
18	3	4600	3680	5520	4-1/2	2-7/16	1-1/4	57-3/4		PY1850920	
18	4	6500	5200	7800	5-1/4	2-7/16	1-1/4	83	PY1870120		
18	4	6500	5200	7800	5-1/4		1-1/2	83	PY1870124		
18	4	6500	5200	7800	5-1/2	2-7/16	1-1/4	81-3/4		PY1870920	
18	5	8400	6720	10080	5-1/4	2-7/16	1-1/2	89	PY1880124		
18	5	8400	6720	10080	5-1/4	3-1/16	1-3/4	89	PY1880128		
18	5	8400	6720	10080	5-1/4	3-1/4	2	89	PY1880132		
18	5	8400	6720	10080	5-1/2	2-9/16	1-1/2	87-3/4		PY1880924	

PX



Thick Tread Polyurethane on Cast Iron Core



PX wheels are composed of a polyurethane elastomer, open cast on clean, precision tolerance cores. Polyurethane tread is chemically bonded to a cast iron core. High capacity polyurethane protects floors, is non-marking and delivers quieter operation than standard metal wheels.

FEATURES

- **Thickness:** 1" thick polyurethane tread
- **Wheel Face:** Available in flat or 3° crown
- **Hardness:** 95 Shore A
- **Finish:** Green tread on black core
- **Temperature Range:** -40°F to +180°F

WHEEL OPTIONS

- **80 Shore A** durometer option available (20% capacity reduction). Provides more debris resistance. Red-orange on black core
- **70 Shore D** durometer option available (20% capacity increase). Black tread on black core.
- **Note:** Select bearings featured are recommended for standard applications. For special applications or alternate bearings consult factory. See bearing information on page 13
- For customization & special application options, please consult factory
- Tapered bearings are recommended for towing applications



70 Shore D Models
Capacity increases 20% for 70 Shore D durometer models
(To order, add 70D to end of wheel number)



Ergonomic Option 80 Shore A Models
Capacity decreases 20% for 80 Shore A durometer models
(To order, add 80A to end of wheel number)

Thick Tread Polyurethane on Cast Iron Core (PX)										Wheel Number Tapered Roller Bearing (01)	Wheel Number Roller Bearing (09)
Wheel Diameter (Inches)	Tread Width (Inches)	Capacity (Lbs) (Rate for manual operation)	Hub Length (Inches)	Bore ID (Inches)	Bearing ID (Inches)	Approx. Wt. (Lbs)					
6	3	2250	3-1/4	1-15/16	1	13-3/4			PX0650116		
6	3	2250	3-1/4	1-15/16	1-1/4	13-3/4			PX0650120		
6	3	2250	3-1/2	1-15/16	3/4	13-1/4				PX0650912	
6	3	2250	3-1/2	1.98	1	13-1/4				PX0650916	
8	2-1/2	2200	3-1/4	1-15/16	1	13			PX0840116		
8	2-1/2	2200	3-1/4	1-15/16	1-1/4	13			PX0840120		
8	2-1/2	2200	3-1/2	1-15/16	3/4	12-3/4				PX0840912	
8	3	2780	3-1/4	1-15/16	1	16			PX0850116		
8	3	2780	3-1/4	1-15/16	1-1/4	16			PX0850120		
8	3	2780	3-1/2	1-15/16	3/4	15-3/4				PX0850912	
8	3	2780	3-1/2	1.98	1	15-3/4				PX0850916	
8	4	3850	4-1/4	2-7/16	1-1/4	23-3/4			PX0870120		
8	4	3850	4-1/4	2-7/16	1-1/2	23-3/4			PX0870124		
8	4	3850	4-1/2	2-7/16	1	22-1/2				PX0870916	
8	4	3850	4-1/2	2-7/16	1-1/4	22-1/2				PX0870920	
10	2-1/2	2600	3-1/4	1-15/16	1	17-1/4			PX1040116		
10	2-1/2	2600	3-1/4	1-15/16	1-1/4	17-1/4			PX1040120		
10	3	3300	3-1/4	1-15/16	1	20-1/2			PX1050116		
10	3	3300	3-1/4	1-15/16	1-1/4	20-1/2			PX1050120		
10	3	3300	3-1/2	1-15/16	3/4	20				PX1050912	
10	3	3300	3-1/2	1.98	1	20				PX1050916	
10	3	3300	3-1/2	2.33	1-1/4	20				PX1050920	
10	4	4620	4-1/4	2-7/16	1-1/4	30-1/4			PX1070120		
10	4	4620	4-1/4	2-7/16	1-1/2	30-1/4			PX1070124		
10	4	4620	4-1/2	2-7/16	1	29				PX1070916	
10	4	4620	4-1/2	2-7/16	1-1/4	29				PX1070920	
10	5	5500	5-1/4	2-7/16	1-1/4	41-1/4			PX1080120		
10	5	5500	5-1/4	2-7/16	1-1/2	41-1/4			PX1080124		
10	5	5500	5-1/2	2-7/16	1	39-1/4				PX1080916	
10	5	5500	5-1/2	2-7/16	1-1/4	39-1/4				PX1080920	
12	3	3760	3-1/4	1-15/16	1	28-1/4			PX1250116		
12	3	3760	3-1/4	1-15/16	1-1/4	28-1/4			PX1250120		
12	3	3760	3-1/2	1-15/16	3/4	28				PX1250912	
12	3	3760	3-1/2	1.98	1	28				PX1250916	
12	3	3760	3-1/2	2.33	1-1/4	28				PX1250920	
12	4	5280	4-1/4	2-7/16	1-1/4	36-3/4			PX1270120		
12	4	5280	4-1/4	2-7/16	1-1/2	36-3/4			PX1270124		
12	4	5280	4-1/2	2-7/16	1	35-1/2				PX1270916	
12	4	5280	4-1/2	2-7/16	1-1/4	35-1/2				PX1270920	
12	5	6600	5-1/4	2-7/16	1-1/4	48			PX1280120		
12	5	6600	5-1/4	2-7/16	1-1/2	48			PX1280124		
12	5	6600	5-1/2	2-7/16	1	47				PX1280916	
12	5	6600	5-1/2	2-7/16	1-1/4	47				PX1280920	
12	6	8250	6-1/2	2.33	1-1/4	25-3/4				PX1290920	
16	3	4680	4-1/4	2-7/16	1-1/4	51			PX1650120		
16	3	4680	4-1/4	2-7/16	1-1/2	51			PX1650124		
16	3	4680	4-1/2	2-7/16	1	49-3/4				PX1650916	
16	3	4680	4-1/2	2-7/16	1-1/4	49-3/4				PX1650920	
16	4	6570	4-1/4	2-7/16	1-1/4	65			PX1670120		
16	4	6570	4-1/4	2-7/16	1-1/2	65			PX1670124		
16	4	6570	4-1/2	2-7/16	1-1/4	63				PX1670920	
16	5	8470	5-1/4	2-7/16	1-1/4	85			PX1680120		
16	5	8470	5-1/4	2-7/16	1-1/2	85			PX1680124		
16	5	8470	5-1/2	2-7/16	1-1/4	85				PX1680920	

POLYURETHANE ON CAST IRON • UP TO 8470

^Towing: Consult factory prior to ordering to ensure selection supports your towing requirement

PF



Ergonomic



Maintenance Free



Premium Quality



Towing[^]

Polyurethane on Heavy Duty Cast Iron



Ergonomic polyurethane tread is firmly bonded to precision machined cast iron core and features precision ball bearings for smooth, reliability mobility in both hand operated or towed applications.

FEATURES

- **Hardness:** 95 Shore A
- **Wheel Face:** Radius tread
- **Finish:** Yellow on black core
- **Temperature Range:** -40°F to +180°F

WHEEL OPTIONS

- Note: Select bearings featured are recommended for standard applications. For special applications or alternate bearings consult factory. See bearing information on page 13
- For customization & special application options, please consult factory

Wheel Diameter (Inches)	Tread Width (Inches)	Capacity (Lbs) (Based on manual operation)	Hub Length (Inches)	Bore ID (Inches)	Bearing ID (Inches)	Approx. Wt. (Lbs)	Wheel Number Precision Ball Bearing (28)	Wheel Number Tapered Roller Bearing (09)
Polyurethane on Heavy Duty Cast Iron (PF)								
6	2	2000	2-7/16	47mm	1/2		PF0622808	
6	2-1/2	2900	3	52mm	3/4		PF064281201	
6	2-1/2	2900	3-1/2	52mm	3/4		PF0642812	
8	2	2200	2-7/16	47mm	1/2		PF0822808	
8	2-1/2	3100	3-1/2	52mm	3/4		PF0842812	
8	2-1/2	3100	3	52mm	3/4		PF084281201	
8	3	4000	3-1/2	62mm	3/4		PF0852812	
10	2-1/2	3300	3-1/2	52mm	3/4		PF1042812	
10	2-1/2	3300	3	52mm	3/4		PF104281201	
10	3	4200	3-1/2	62mm	3/4		PF1052812	
10	5	8000	5-1/2	2-7/16"	1-1/4			PF1280920
12	3	4400	3-1/2	62mm	3/4		PF1252812	
12	5	10000	5-1/2	2-7/16"	1-1/4			PF1280920
16	5	10500	5-1/2	2-7/16"	1-1/4			PF1680920

PI



Economical

Polyurethane on Cast Iron



PI wheels are composed of a polyurethane elastomer, open cast or injection molded, on clean, close tolerance cores. Polyurethane tread is chemically bonded to a cast iron core. High capacity polyurethane protects floors, is non-marking and delivers quieter operation than standard metal wheels.

FEATURES

- **Hardness:** 95 Shore A
- **Wheel Face:** Available in flat tread
- **Finish:** Green tread on silver painted core
- **Temperature Range:** -40 °F to +180°F

WHEEL OPTIONS

- Note: Select bearings featured are recommended for standard applications. For special applications or alternate bearings consult factory. See bearing information on page 13
- For customization & special application options, please consult factory

Wheel Diameter (Inches)	Tread Width (Inches)	Capacity (Lbs) (Based on manual operation)	Hub Length (Inches)	Bore ID (Inches)	Bearing ID (Inches)	Approx. Wt. (Lbs)	Wheel Number Roller Bearing (01)	Wheel Number Plain Bearing (00)
Polyurethane on Cast Iron (PI)								
6	2-1/2	1600	2-3/4	1-3/16	3/4			PI0640019
6	2-1/2	1600	3-1/4	1-15/16	1		PI0640116	
6	3	2000	3-1/4	1-15/16	3/4			PI0650031
6	3	2000	3-1/4	1-15/16	1		PI0650116	
8	2-1/2	2000	3-1/4	1-15/16	3/4			PI0840031
8	2-1/2	2000	3-1/4	1-15/16	1		PI0840116	
8	3	2500	3-1/4	1-15/16	1		PI0850116	
8	3	2500	3-1/4	1-15/16	3/4			PI0850031
10	2-1/2	2200	3-1/4	1-15/16	1		PI1040116	
10	2-1/2	2200	3-1/4	1-15/16	3/4			PI1040031
10	3	3000	3-1/4	1-15/16	1		PI1050116	
10	3	3000	3-1/4	1-15/16	3/4			PI1050031
12	2-1/2	2500	3-1/4	1-15/16	3/4			PI1240031
12	3	3500	3-1/4	1-15/16	1		PI1250116	
12	3	3500	3-1/4	1-15/16	3/4			PI1250031

PR



Premium Quality



Ergonomic



Maintenance Free

Polyurethane Reactive



This special polyurethane material is resistant to picking up metal chips. Wheels are quiet rolling and provide easy turning.

FEATURES

- **Wheel Face:** Round tread
- **Finish:** Reddish brown tread on black core
- **Temperature Range:** -40°F to +180°F
- **Hardness:** 80 Shore A

WHEEL OPTIONS

- Note: Select bearings featured are recommended for standard applications. For special applications or alternate bearings consult factory. See bearing information on page 13
- For customization & special application options, please consult factory

Wheel Diameter (Inches)	Tread Width (Inches)	Capacity (Lbs) (rated for manual operation)	Hub Length (Inches)	Bore ID (Inches)	Bearing ID (Inches)	Approx. Wt. (Lbs)	Wheel Number Roller Bearing (01)	Wheel Number Precision Ball Bearing (28)
Polyurethane Reactive on Cast Iron (PR)								
10	3	2400	3-1/2	1-15/16	3/4			PR1052812
10	3	2400	3-1/4	1-15/16	1		PR1050116	
12	3	2800	3-1/2	1-15/16	3/4			PR1252812
12	3	2800	3-1/4	1-15/16	1		PR1250116	

PA/PD



Premium Quality

Polyurethane on Aluminum Core



Composed of a polyurethane elastomer, open cast on clean, close tolerance cores. Polyurethane tread is chemically bonded to aluminum core. High capacity polyurethane protects floors, is non-marking and delivers quieter operation than standard metal wheels. PA wheels feature cast aluminum cores. PD wheels feature die cast aluminum cores.

FEATURES

- **Finish:** Green tread on aluminum core
- **Temperature Range:** -40°F to +180°F
- **Hardness:** PA 95 Shore A
PD 60 Shore D

WHEEL OPTIONS

- Note: Select bearings featured are recommended for standard applications. For special applications or alternate bearings consult factory. See bearing information on page 13
- For customization & special application options, please consult factory

Wheel Diameter (Inches)	Tread Width (Inches)	Capacity (Lbs) (rated for manual operation)	Hub Length (Inches)	Bore ID (Inches)	Bearing ID (Inches)	Approx. Wt. (Lbs)	Wheel Number Roller Bearing (01,09)	Wheel Number Precision Ball Bearing (28)
Polyurethane on Aluminum Core (PA, PD)								
4	1-1/2	600	1-5/8	1-3/16	1/2	1	PD0410108	
4	1-1/2	600	1-5/8	1-3/16	5/8	1	PD0410110	
4	1-1/2 [^]	600	1-5/8	1-3/16	3/4	1	PD0410112~	
4	2	700	2-3/16	1-3/16	1/2	1-1/2	PD0420108	
4	2	700	2-3/16	1-3/16	5/8	1-1/2	PD0420110	
4	2	700	2-3/16	1-3/16	3/4	1-1/2	PD0420112~	
4	3-1/4	1200	3-1/4	1-15/16	1	3-1/4	PA0450116	
4	3-1/4	1200	3-1/4	1-15/16	1-1/4	3-1/4	PA0450120	
4	4-1/4	1600	4-1/4	1-15/16	1	4-1/4	PA0470116	
4	4-1/4	1600	4-1/4	1-15/16	1-1/4	4-1/4	PA0470120	
5	1-1/2	720	1-5/8	1-3/16	1/2	1-1/2	PD0510108	
5	1-1/2	720	1-5/8	1-3/16	5/8	1-1/2	PD0510110	
5	1-1/2 [^]	720	1-5/8	1-3/16	3/4	1-1/2	PD0510112~	
5	2	1050	2-3/16	1-3/16	1/2	1-3/4	PD0520108	
5	2	1050	2-3/16	1-3/16	5/8	1-3/4	PD0520110	
5	2	1050	2-3/16	1-3/16	3/4	1-3/4	PD0520112	
6	2	1230	2-3/16	1-3/16	1/2	2-1/4	PD0620108	
6	2	1230	2-3/16	1-3/16	5/8	2-1/4	PD0620110	
6	2	1230	2-3/16	1-3/16	3/4	2-1/4	PD0620112~	
8	2	1500	2-3/16	1-3/16	1/2	3-1/4	PD0820108	
8	2	1500	2-3/16	1-3/16	5/8	3-1/4	PD0820110	
8	2	1500	2-3/16	1-3/16	3/4	3-1/4	PD0820112~	
8	2-1/2	2010	3-1/4	1-15/16	1	4	PD0840116	
8	2-1/2	2010	3-1/2	2	3/4	4		PD0842812
8	3	2520	3-1/4	1-15/16	1	4-1/4	PD0850116	
8	3	2520	3-1/4	1-15/16	1-1/4	4-1/4	PD0850120	
8	3	2520	3-1/2	2	3/4	4-1/4		PD0852812
10	2-1/2	2370	3-1/4	1-15/16	1	4-3/4	PD1040116	
10	2-1/2	2370	3-1/2	2	3/4	4-3/4		PD1042812
10	3	3000	3-1/4	1-15/16	1	5	PD1050116	
10	3	3000	3-1/4	1-15/16	1	5	PD1050116	
10	3	3000	3-1/4	1-15/16	1-1/4	5	PD1050120	
10	3	3000	3-1/4	1-15/16	3/4	5		PD1052812
12	6	7500	6-1/2	2.33	1-1/4	25-3/4	PA1290920	

~ Wheels are complete with spanner bushing and nylon sealed retaining/thrust washer.
[^] 27/16" spanner and spacers included.

PM



Ergonomic



Premium Quality



Maintenance Free

Round Tread Polyurethane on Aluminum Core



95 Shore A Models

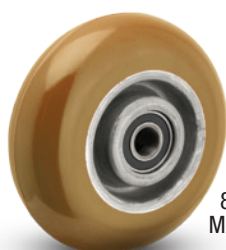

80 Shore A Models

Composed of a polyurethane elastomer, open cast on clean, close tolerance cores. Wheels feature a chemical and mechanical lock of tread to the core. High capacity polyurethane protects floors, is non-marking and delivers quieter operation than standard metal wheels.

FEATURES

- **Wheel face:** Round tread
- **Finish:** Green tread on aluminum core
- **Temperature Range:** -40°F to +180°F
- **Hardness:** 95 Shore A (green) or 80 Shore A (butterscotch)
- Wheels are complete with top hat and spacers

WHEEL OPTIONS

- Available in **80 Shore A** and **70 Shore D**, consult factory.
- Note: Select bearings featured are recommended for standard applications. For special applications or alternate bearings consult factory. See bearing information on page 13
- For customization & special application options, please consult factory



Tread is mechanically and chemically bonded through a patented process to a lightweight durable aluminum core

Wheel Diameter (inches)	Tread Width (inches)	Capacity (Lbs) (rated for manual operation)	Hub Length (inches)	Bore ID (inches)	Bearing ID (inches)	Approx. Wt. (Lbs)	Wheel Number Precision Ball (28)
Round Tread Polyurethane on Aluminum Core (PM 95A)							
5	2	1000	2-7/16	1-9/16	1/2	2	PM0522808
6	2	1250	2-7/16	1-9/16	1/2	3	PM0622808
8	2	1500	2-7/16	1-9/16	1/2	4	PM0822808

Wheel Diameter (inches)	Tread Width (inches)	Capacity (Lbs) (rated for manual operation)	Hub Length (inches)	Bore ID (inches)	Bearing ID (inches)	Approx. Wt. (Lbs)	Wheel Number Precision Ball (28)
Round Tread Polyurethane on Aluminum Core (PM 80A)							
5	2	1000	2-7/16	1-9/16	1/2	2	PM052280880A
6	2	1250	2-7/16	1-9/16	1/2	3	PM062280880A
8	2	1500	2-7/16	1-9/16	1/2	4	PM082280880A

NEW

AX



Ergonomic



Maintenance Free



Premium Quality



Towing[^]

Round Tread Polyurethane on Aluminum Core



Most Ergonomic Solution:

- Easiest movement
- Reduces noise
- Debris resistant
- Floor protective

Designed for ergonomic applications. Wheels feature a chemical and mechanical lock of tread to the core. High capacity polyurethane protects floors, is non-marking and delivers quieter operation than standard metal wheels.

FEATURES

- **Wheel face:** Round tread
- **Finish:** Red tread on aluminum core
- **Temperature Range:** -40°F to +180°F
- **Hardness:** 85 Shore A
- Wheels are complete with top hat and spacers

WHEEL OPTIONS

- For customization & special application options, please consult factory



Wheel Diameter (inches)	Tread Width (inches)	Capacity (Lbs) (rated for manual operation)	Hub Length (inches)	Bore ID (inches)	Bearing ID (inches)	Approx. Wt. (Lbs)	Wheel Number Precision Ball (28)
Round Tread Polyurethane on Aluminum Core (AX)							
4	2	800	2-7/16	1-9/16	1/2	1-1/2	AX0422808
5	2	1000	2-7/16	1-9/16	1/2	2	AX0522808
6	2	1250	2-7/16	1-9/16	1/2	3	AX0622808
8	2	1500	2-7/16	1-9/16	1/2	4	AX0822808

UA



Ergonomic



Premium Quality



Maintenance Free



Towing[^]

Magnum Round Tread Polyurethane on Aluminum Core

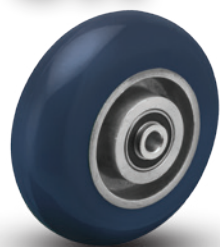

Made in the USA

Magnum polyurethane wheels are designed to meet today's most stringent ergonomic needs. These premium polyurethane wheels are standard with crowned treads, sealed precision ball bearings and top hat reducing bushings for optimum rollability. Magnum wheels will perform well in both manual and power-towed material handling applications.

FEATURES

- **Wheel face:** Round tread
- **Finish:** Blue, Red, Orange or Black on Aluminum
- **Temperature Range:** -40°F to +180°F
- **Hardness:** Standard blue 95 Shore A
- Wheels are complete with top hat and spacers

WHEEL OPTIONS

- Note: Select bearings featured are recommended for standard applications. For special applications or alternate bearings consult factory. See bearing information on page 13
- For customization & special application options, please consult factory



95 Shore A



80 Shore A



73 Shore D



70 Shore A

Wheel Diameter (Inches)	Tread Width (Inches)	Capacity (Lbs) (Rate for manual operation)	Hub Length (Inches)	Bore ID (Inches)	Bearing ID (Inches)	Approx. Wt. (Lbs)	Wheel Number Precision Ball (28)
-------------------------	----------------------	--	---------------------	------------------	---------------------	-------------------	----------------------------------

Blue Round Tread Polyurethane on Aluminum Core (UA)							
4	2	700	2-7/16	1-9/16	1/2	2	UA0422808
6	2	750	2-7/16	1-9/16	1/2	3	UA0622808
8	2	900	2-7/16	1-9/16	1/2	4	UA0822808

Red Round Tread Polyurethane on Aluminum Core (UA 80A)							
4	2	500	2-7/16	1-9/16	1/2	2	UA042280880A
6	2	500	2-7/16	1-9/16	1/2	3	UA062280880A
8	2	800	2-7/16	1-9/16	1/2	4	UA082280880A

Orange Round Tread Polyurethane on Aluminum Core (UA 73D)							
4	2	900	2-7/16	1-9/16	1/2	2	UA042280873D
6	2	1000	2-7/16	1-9/16	1/2	3	UA062280873D
8	2	1200	2-7/16	1-9/16	1/2	4	UA082280873D

Black Round Tread Polyurethane on Aluminum Core (UA 70A)							
4	2	400	2-7/16	1-9/16	1/2	2	UA042280870A
6	2	410	2-7/16	1-9/16	1/2	3	UA062280870A
8	2	500	2-7/16	1-9/16	1/2	4	UA082280870A

POLYURETHANE ON ALUMINUM • UP TO 1200

Excellent in automotive manufacturing applications!



[^]Towing: Consult factory prior to ordering to ensure selection supports your towing requirement

EY/EZ



Ergonomic



Maintenance Free

Aubin Industries Swivel-EAZ® Crown/Flat Tread

Made in the USA



Dual wheels give the Swivel-EAZ® extremely high rollability and durability. Capacities range from 500 lbs to 4800 lbs depending on wheel size and durometer. Also available in 70A, 80A, 60D, and 75D. Made in the USA.



FEATURES

- **Wheel face:** Dual wheel crowned tread (EZ) or flat tread (EY)
- **Finish:** Standard Blue on aluminum
- **Temperature Range:** -40°F to +180°F
- **Hardness:** Standard blue 95 Shore A

WHEEL OPTIONS

- Note: Select bearings featured are recommended for standard applications. For special applications or alternate bearings consult factory. See bearing information on page 13
- For other available durometers please consult factory

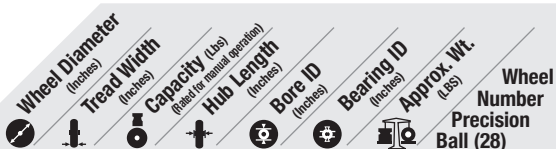

Swivel-EAZ Crowned Tread (EY)							
4	2	675	2-1/2	N/A	1/2		EY0422808
5	2	900	2-1/2	N/A	1/2		EY0522808
6	2	1425	2-1/2	N/A	1/2		EY0622808
6	3	2137	3-1/2	N/A	3/4		EY0652812
8	2	2400	2-1/2	N/A	1/2		EY0822808
8	3	3250	3-1/2	N/A	3/4		EY0852812
10	3	3800	3-1/2	N/A	3/4		EY1052812

Swivel-EAZ Flat Tread (EZ)							
4	2	900	2-1/2	N/A	1/2		EZ0422808
5	2	1400	2-1/2	N/A	1/2		EZ0522808
6	2	1900	2-1/2	N/A	1/2		EZ0622808
6	3	2850	3-1/2	N/A	3/4		EZ0652812
8	2	3000	2-1/2	N/A	1/2		EZ0822808
8	3	4000	3-1/2	N/A	3/4		EZ0852812
10	3	4800	3-1/2	N/A	3/4		EZ1052812

95A durometer is standard; for optional durometers please consult factory.

About Swivel-EAZ®

Swivel-EAZ® By Aubin Industries is a revolutionary rolling system. Available in more than 350 patented sizes and configurations with more being added regularly. The Swivel-EAZ is the "New Standard for Logistics" in the Material Handling Industry.

Durometer Options



70A (Black)



80A (Red)



95A (Blue)



60D (Gray)



75D (Black)

Wheel capacities are lower for 70A and 80A. Consult factory.

Wheel capacities are higher for 60D and 75D. Consult factory.



ALBION[®]

the caster experts

New Proprietary Poured Mold Techniques
for a Smoother, Cleaner Wheel with no Parting Lines

Solid Polyurethane X-treme Wheels



 **USA**
Made in the



X-treme

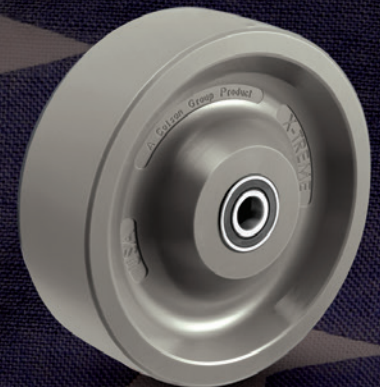

X-treme Plus

See Page 160

- Specifically designed for applications involving:
chemicals, solvents, and water
- Low rolling resistance and crowned tread for ergonomics
- Solid elastomer construction for no tread failures
- Non-marking and floor protective



THE GLOBAL LEADER IN CASTERS AND WHEELS.

Made in the **USA**



XI/XP X-Treme Solid Polyurethane

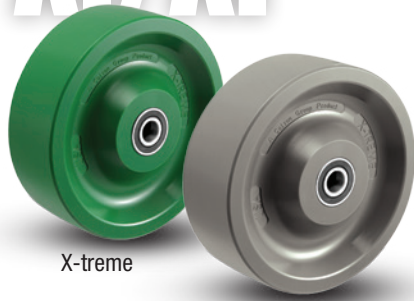

X-treme

X-treme Plus

Albion X-treme and X-treme Plus wheels have been a very popular solid polyurethane choice for years, but now Albion has taken the wheels to a new level. Instead of compression molding, Albion now uses a proprietary poured mold technique that results in a cleaner, smoother looking wheel. These wheels are designed specifically for high-capacity manual applications involving chemicals, solvents or water. X-tremely low rolling resistance and the crowned tread make this wheel your choice for ergonomic applications. One-piece construction affords freedom from tread separation with an exceptionally long life. The solid polyurethane material is non-marking and provides floor protection.

FEATURES

- **Hardness:**
X-treme: 70 Shore D
X-treme Plus: 60 Shore D
- **Wheel face:** Crowned tread
- **Finish:**
X-treme: Green
X-treme Plus: Grey
- **Temperature Range:**
Up to +180°F

WHEEL OPTIONS

- Note: Select bearings featured are recommended for standard applications. For special applications or alternate bearings consult factory. See bearing information on page 13
- For customization & special application options, please consult factory

X-Treme Solid Polyurethane (XI)									
Wheel Diameter (Inches)	Tread Width (Inches)	Capacity (Lbs) (Based for manual operation)	Hub Length (Inches)	Bore ID (Inches)	Bearing ID (Inches)	Approx. Wt. (Lbs)	Wheel Number Roller Bearing (01)	Wheel Number Delrin Bearing (51)	Wheel Number Precision Ball (28)*
3-1/4	2	900	2-3/16	1-3/16	3/4	1	XI0320112	XI0325112	
3-1/4	2	900	2-7/16	1-9/16	1/2	1			XI0322808
4	2	1000	2-3/16	1-3/16	3/4	1	XI0420112	XI0425112	
4	2	1000	2-7/16	1-9/16	1/2	1			XI0422808
5	2	1000	2-3/16	1-3/16	3/4	1-1/2	XI0520112	XI0525112	
5	2	1000	2-7/16	1-9/16	1/2	1-1/2			XI0522808
6	2	1000	2-3/16	1-3/16	3/4	1-3/4	XI0620112	XI0625112	
6	2	1000	2-7/16	1-9/16	1/2	1-3/4			XI0622808
8	2	1000	2-3/16	1-3/16	3/4	4	XI0820112	XI0825112	
8	2	1000	2-7/16	1-9/16	1/2	4			XI0822808

X-Treme Plus Solid Polyurethane (XP)									
Wheel Diameter (Inches)	Tread Width (Inches)	Capacity (Lbs) (Based for manual operation)	Hub Length (Inches)	Bore ID (Inches)	Bearing ID (Inches)	Approx. Wt. (Lbs)	Wheel Number Roller Bearing (01)	Wheel Number Delrin Bearing (51)	Wheel Number Precision Ball (28)*
3-1/4"	2	900	2-3/16	1-3/16	3/4	1	XP0320112	XP0325112	
3-1/4"	2	900	2-7/16	1-9/16	1/2	1			XP0322808
4	2	1400	2-3/16	1-3/16	3/4	1	XP0420112	XP0425112	
4	2	1400	2-7/16	1-9/16	1/2	1			XP0422808
5	2	1200	2-3/16	1-3/16	3/4	1-1/2	XP0520112	XP0525112	
5	2	1200	2-7/16	1-9/16	1/2	1-1/2			XP0522808
6	2	1400	2-3/16	1-3/16	3/4	1-3/4	XP0620112	XP0625112	
6	2	1400	2-7/16	1-9/16	1/2	1-3/4			XP0622808
6	3	1700	3-1/2	2-7/16	3/4	5	XP0650112	XP0655112	
6	3	1700	3-1/2	2-7/16	3/4	5			XP0652812
8	2	1200	2-3/16	1-3/16	3/4	4	XP0820112	XP0825112	
8	2	1200	2-7/16	1-9/16	1/2	4			XP0822808
8	2-1/2	2000	3-1/2	2-7/16	3/4	5	XP0840112	XP0845112	
8	2-1/2	2000	3-1/2	2-7/16	3/4	5			XP0842812
8	3	2000	3-1/2	2-7/16	3/4	6	XP0850112	XP0855112	
8	3	2000	3-1/2	2-7/16	3/4	6			XP0852812
10	2-1/2	2500	3-1/2	2-7/16	3/4	7	XP1040112	XP1045112	
10	2-1/2	2500	3-1/2	2-7/16	3/4	7			XP1042812
10	3	2500	3-1/2	2-7/16	3/4	8	XP105112	XP1055112	
10	3	2500	3-1/2	2-7/16	3/4	8			XP1052812

Roller bearings are complete with spanner bushing & nylon sealed retaining washers.

* Pedestal Precision Ball (29) bearings also available. To order change "28" to "29".

Example: XI0322908

X-Treme Advantages

- Specifically designed for applications involving: Chemicals, Solvents, and Water
- USA made for fast deliveries
- No parting lines in the middle of the tread, providing a smooth roll and clean appearance
- Low rolling resistance and crowned tread for ergonomics
- Solid polyurethane construction for no tread failures
- Non-marking and floor protective

SE



Solid Elastomer

Made in the USA

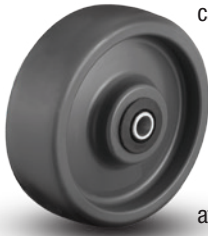

Designed specifically for high-capacity manual applications involving chemicals, solvents or water. Low rolling resistance provides the ergonomic qualities you demand. One-piece construction affords freedom from tread separation with an exceptionally long life. Non-marking, floor protective tread.

FEATURES

- **Wheel Face:** Moderate crown
- **Finish:** Grey
- **Temperature Range:** up to +230°F
- **Hardness:** 63(±5) Shore D

WHEEL OPTIONS

- Note: Select bearings featured are recommended for standard applications. For special applications or alternate bearings consult factory. See bearing information on page 13
- For customization & special application options, please consult factory

Wheel Diameter (Inches)	Tread Width (Inches)	Capacity (Lbs) (Based on manual operation)	Hub Length (Inches)	Bore ID (Inches)	Bearing ID (Inches)	Approx. Wt. (Lbs)	Wheel Number Delrin Bearing (51)	Ergonomic Wheel Number Precision Ball (28)	Wheel Number Roller Bearing (01)
Solid Elastomer Polyurethane (SE)									
4	2	1000	2-3/16	1-3/16	3/4	1	SE0425112		SE0420112~
4	2	1000	2-7/16	-	1/2	1		SE0422808	
5	2	1000	2-3/16	1-3/16	3/4	1-1/2	SE0525112		SE0520112~
5	2	1000	2-7/16	-	1/2	1-1/2		SE0522808	
6	2	1100	2-3/16	1-3/16	3/4	1-3/4	SE0625112		SE0620112~
6	2	1100	2-7/16	-	1/2	1-3/4		SE0622808	
8	2	1200	2-3/16	1-3/16	3/4	4	SE0825112		SE0820112~
8	2	1200	2-7/16	-	1/2	4		SE0822808	

~ Wheels are complete with spanner bushing & nylon sealed retaining washers.
• Hub length is 2-3/8" for Delrin models.

XA



Polyurethane on Polypropylene Core



This wheel has excellent properties where washdown of material handling equipment is required. Tread is mechanically locked to an injection molded polymer core to prevent separation. Polyurethane wheels offer greater load capacity than rubber. They offer excellent floor protection. These wheels resist chemicals, acids, caustics and oils. Color is grey on grey core.

FEATURES

- **Wheel Face:** Moderate crown
- **Finish:** Grey tread on grey core
- **Temperature Range:** -40°F to +180°F
- **Hardness:** 63(±5) Shore D

WHEEL OPTIONS

- Prevenz™ Antimicrobial wheel available, specify **PREV**
- Note: Select bearings featured are recommended for standard applications. For special applications or alternate bearings consult factory. See bearing information on page 13
- For customization & special application options, please consult factory

Wheel Diameter (Inches)	Tread Width (Inches)	Capacity (Lbs) (Based on manual operation)	Hub Length (Inches)	Bore ID (Inches)	Bearing ID (Inches)	Approx. Wt. (Lbs)	Wheel Number Roller Bearing (01, 31)	Wheel Number Precision Ball Bearing (28)
Polyurethane on Polypropylene (XA)								
3	1-1/4	300	1-1/2	-	3/8	3/8	XA0303106	XA0302806*
3-1/2	1-1/4	360	1-1/2	-	3/8	3/8	XA03X3106	XA03X2806*
4	1-1/4	400	1-1/2	-	3/8	1/2	XA0403106	XA0402806*
4	2	600	2-3/16	1-3/16	3/4	1/2	XA0420112~	
5	1-1/4	440	1-1/2	-	3/8	3/4	XA0503106	XA0502806*
5	2	750	2-3/16	1-3/16	3/4	1-3/4	XA0520112~	
6	2	900	2-3/16	1-3/16	3/4	2-1/2	XA0620112~	
8	2	1000	2-3/16	1-3/16	3/4	2-3/4	XA0820112~	
10	2-1/2	1500	3-1/4	1-15/16	1	3	XA1040116	

~ Wheels are complete with spanner bushing and nylon sealed retaining thrust washer.
*Complete with thread guard spacer.

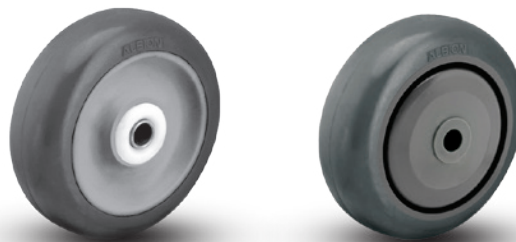

*Precision Bearing models come standard with thread guards.

SOLID POLYURETHANE & TPU • UP TO 1500



Eagle Polyurethane on Polypropylene



Albion's Eagle (EG) wheel is suited for a wide range of industrial applications and can withstand load capacities of 600 to 1,200 lbs. This wheel's unique, interlocking polyurethane tread on heavy duty polypropylene core offers superior adhesion for medium to heavy duty weight capacities.

Wheel Diameter (Inches)	Tread Width (Inches)	Capacity (Lbs) (Based on manual operation)	Hub Length (Inches)	Bore ID (Inches)	Bearing ID (Inches)	Approx. Wt. (Lbs)	Wheel Number Roller Bearing (01)	Wheel Number Delrin Bearing (51)	Wheel Number Pedestal Precision Ball Bearing (29)
Eagle Polyurethane on Polypropylene (EG)									
4	2	600	2-3/16	1-3/16	3/4		EG0420112	EG0425112	
4	2	600	2-3/16	1-3/16	1/2				EG0422908
5	2	900	2-3/16	1-3/16	3/4		EG0520112	EG0525112	
5	2	900	2-3/16	1-3/16	1/2				EG0522908
6	2	1100	2-3/16	1-3/16	3/4		EG0620112	EG0625112	
6	2	1100	2-3/16	1-3/16	1/2				EG0622908
8	2	1200	2-3/16	1-3/16	3/4		EG0820112	EG0825112	
8	2	1200	2-3/16	1-3/16	1/2				EG0822908

FEATURES

- **Wheel Face:** Crowned tread
- **Finish:** Blue on black core
- **Temperature Range:** -40°F to +180°F. See intermittent chart below for higher temp applications
- **Hardness:** 95 Shore A

- Excellent for clean applications
- Offers superior durability

WHEEL OPTIONS

- Note: Select bearings featured are recommended for standard applications. For special applications or alternate bearings consult factory. See bearing information on page 13
- For customization & special application options, please consult factory

MAXIMUM AMBIENT WHEEL TEMPERATURE VERSUS TIME

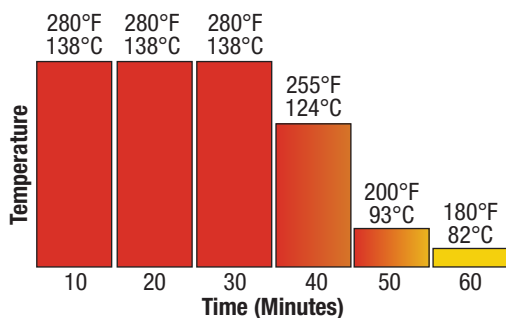

OG



Premium Quality

Polyurethane Press-On Tires

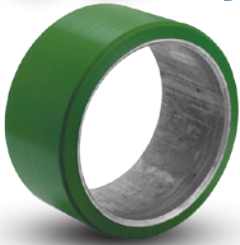

Polyurethane tires reduce operating cost because the high wear resistance of this material minimizes replacement. Polyurethane offers easier rollability, higher wear resistance, and greater capacity than rubber. Use press-on polyurethane as an alternative to standard mold-on polyurethane when greater cushioning or speed is involved. These wheels are also the perfect replacement wheel for many forklift brands.

FEATURES

- **Load Capacity:** 1.54 times greater than rubber
- Chunk and cut resistance
- Abrasion resistance
- Energy conservative design
- **Wheel Face:** as specified
- **Finish:** Green polyurethane or steel band
- **Temperature Range:** -40°F to +180°F
- **Hardness:** 95 Shore A

WHEEL OPTIONS

- Note: Select bearings featured are recommended for standard applications. For special applications or alternate bearings consult factory. See bearing information on page 13
- For customization & special application options, please consult factory



- Heavy Duty
- High Wear Resistance

OD x Width x ID (Inches)	Tire Number	Tread Style	Capacity (6 mph) (lbs)	Capacity (10 mph) (lbs)	Approx. Wt. (lbs)
8-1/2 x 4 x 4	OG0870016	Flat	2200	1940	12
8-1/2 x 4 x 4	OG087001601	Crown	2200	1940	12
9 x 5 x 5	OG0980020	Flat	3020	2680	16
9 x 5 x 5	OG098002001	Crown	3020	2680	16
9 x 5 x 5	OG098002002	Groove	3020	2680	16
10 x 3 x 6-1/4	OG1050025	Flat	1690	1490	10
10 x 3 x 6-1/4	OG105002501	Crown	1690	1490	10
10 x 4 x 5	OG1070020	Flat	2480	2190	18
10 x 4 x 5	OG107002001	Crown	2480	2190	18
10 x 4 x 6-1/4	OG1070025	Flat	2460	2190	14
10 x 4 x 6-1/4	OG107002501	Crown	2460	2190	14
10 x 4 x 6-1/2	OG1070026	Flat	2490	2190	14
10 x 4 x 6-1/2	OG107002601	Crown	2490	2190	14
10 x 5 x 5	OG1080020	Flat	3210	2870	15
10 x 5 x 5	OG108002001	Crown	3210	2870	15
10 x 5 x 5	OG108002002	Groove	3210	2870	15
10 x 5 x 6-1/4	OG1080025	Flat	3270	2890	16
10 x 5 x 6-1/4	OG108002501	Crown	3270	2890	16
10 x 5 x 6-1/4	OG108002502	Groove	3270	2890	16
10 x 5 x 6-1/2	OG1080026	Flat	3190	2830	19
10 x 5 x 6-1/2	OG108002601	Crown	3190	2830	19
10 x 5 x 6-1/2	OG108002602	Groove	3190	2830	19
10 x 6 x 6-1/4	OG1090025	Flat	3960	3540	22
10 x 6 x 6-1/4	OG109002501	Crown	3960	3540	22
10 x 6 x 6-1/4	OG109002502	Groove	3960	3540	22
10 x 6 x 6-1/2	OG1090026	Flat	3940	3520	22
10 x 6 x 6-1/2	OG109002601	Crown	3940	3520	22
10 x 6 x 6-1/2	OG109002602	Groove	3940	3520	22
10 x 7 x 6-1/4	OG109002503	Flat	4770	4240	26
10 x 7 x 6-1/4	OG109002504	Groove	4770	4240	26
10 x 7 x 6-1/2	OG109002603	Flat	4750	4290	26
10 x 7 x 6-1/2	OG109002604	Groove	4750	4290	26
10 x 3 x 8	OG1050032	Flat	2000	1850	15
10-1/2 x 3 x 8	OG105003201	Groove	2000	1850	15
10-1/2 x 4 x 5	OG107002002	Flat	2170	1940	19
10-1/2 x 4 x 5	OG107002003	Crown	2170	1940	19
10-1/2 x 4 x 6-1/2	OG107002602	Flat	2130	2260	15
10-1/2 x 4 x 6-1/2	OG107002603	Crown	2130	2260	15
10-1/2 x 4-1/2 x 8	OG107003202	Flat	2820	2500	18
10-1/2 x 4-1/2 x 8	OG107003203	Crown	2820	2500	18
10-1/2 x 5 x 5	OG108002003	Flat	3470	3060	19
10-1/2 x 5 x 5	OG108002004	Crown	3470	3060	19
10-1/2 x 5 x 5	OG108002005	Groove	3470	3060	19
10-1/2 x 5 x 6-1/4	OG108002503	Flat	3330	2970	20
10-1/2 x 5 x 6-1/4	OG108002504	Crown	3330	2970	20
10-1/2 x 5 x 6-1/4	OG108002505	Groove	3330	2970	20
10-1/2 x 5 x 6-1/2	OG108002603	Flat	3380	2990	20
10-1/2 x 5 x 6-1/2	OG108002604	Crown	3380	2990	20
10-1/2 x 5 x 6-1/2	OG108002605	Groove	3380	2990	20

Continue on next page >>

OD x Width x ID (Inches)	Tire Number	Tread Style	Capacity (6 mph) (lbs)	Capacity (10 mph) (lbs)	Approx. Wt. (lbs)
Polyurethane Press-On Tires (OG)					
10-1/2 x 6 x 5	OG1090020	Flat	4400	3900	24
10-1/2 x 6 x 5	OG109002001	Crown	4400	3900	24
10-1/2 x 6 x 5	OG109002002	Groove	4400	3900	24
10-1/2 x 6 x 6-1/4	OG109002505	Flat	4330	3870	23
10-1/2 x 6 x 6-1/4	OG109002506	Crown	4330	3870	23
10-1/2 x 6 x 6-1/4	OG109002507	Groove	4330	3870	23
10-1/2 x 6 x 6-1/2	OG109002605	Flat	4310	3850	23
10-1/2 x 6 x 6-1/2	OG109002606	Crown	4310	3850	23
10-1/2 x 6 x 6-1/2	OG109002607	Groove	4310	3850	23
10-1/2 x 7 x 6-1/2	OG109002608	Flat	5040	4450	27
10-1/2 x 7 x 6-1/2	OG109002609	Groove	5040	4450	27
10-1/2 x 8 x 6-1/2	OG109002610	Flat	5690	5080	31
10-1/2 x 8 x 6-1/2	OG109002611	Groove	5690	5080	31
12 x 3-1/2 x 8	OG1260032	Flat	2390	2110	11
12 x 3-1/2 x 8	OG126003201	Crown	2390	2110	11
12 x 4 x 8	OG1270032	Flat	2840	2510	13
12 x 4 x 8	OG127003201	Crown	2840	2510	13
12 x 4-1/2 x 8	OG127003202	Flat	3300	2910	15
12 x 4-1/2 x 8	OG127003203	Crown	3300	2910	15
12 x 5 x 8	OG1280032	Flat	3770	3300	17
12 x 5 x 8	OG128003201	Crown	3770	3300	17
12 x 5 x 8	OG128003202	Groove	3770	3300	17
12 x 5-1/2 x 8	OG12900320	Flat	4080	3710	19
12 x 5-1/2 x 8	OG129003201	Crown	4080	3710	19
12 x 5-1/2 x 8	OG129003202	Groove	4080	3710	19
12 x 6 x 8	OG129003203	Flat	4520	4110	21
12 x 6 x 8	OG129003204	Crown	4520	4110	21
12 x 6 x 8	OG129003205	Groove	4520	4110	21
12 x 6-1/2 x 8	OG129003206	Flat	4960	4510	23
12 x 6-1/2 x 8	OG129003207	Groove	4960	4510	23
12 x 7 x 8	OG129003208	Flat	5300	4900	25
12 x 7 x 8	OG129003209	Groove	5300	4900	25
13 x 3-1/2 x 8	OG1360032	Flat	2480	2200	20
13 x 3-1/2 x 8	OG136003201	Crown	2480	2200	20
13 x 4-1/2 x 8	OG1370032	Flat	3540	3130	27
13 x 4-1/2 x 8	OG137003201	Crown	3540	3130	27
13 x 5-1/2 x 8	OG1390032	Flat	3600	3240	33
13 x 5-1/2 x 8	OG139003201	Crown	3600	3240	33
13 x 5-1/2 x 8	OG139003202	Groove	3600	3240	33
13-1/2 x 4-1/2 x 8	OG137003202	Flat	3620	3200	28
13-1/2 x 4-1/2 x 8	OG137003203	Crown	3620	3200	28
13-1/2 x 5-1/2 x 8	OG138003203	Flat	4740	4200	34
13-1/2 x 5-1/2 x 8	OG138003204	Crown	4740	4200	34
13-1/2 x 5-1/2 x 8	OG138003205	Groove	4740	4200	34
14 x 4-1/2 x 8	OG1470032	Flat	3680	3260	31
14 x 4-1/2 x 8	OG147003201	Crown	3680	3260	31
15 x 5 x 11-1/4	OG1580045	Flat	4390	3880	33
15 x 5 x 11-1/4	OG158004501	Crown	4390	3880	33
15 x 5 x 11-1/4	OG158004502	Groove	4390	3880	33

OD x Width x ID (Inches)	Tire Number	Tread Style	Capacity (6 mph) (lbs)	Capacity (10 mph) (lbs)	Approx. Wt. (lbs)
Polyurethane Press-On Tires (OG)					
15 x 6 x 11-1/4	OG1590045	Flat	5440	4800	40
15 x 6 x 11-1/4	OG159004501	Crown	5440	4800	40
15 x 6 x 11-1/4	OG159004502	Groove	5440	4800	40
15 x 7 x 11-1/4	OG159004503	Flat	6480	5730	47
15 x 7 x 11-1/4	OG159004504	Groove	6480	5730	47
15 x 8 x 11-1/4	OG159004505	Flat	7530	6650	53
15 x 8 x 11-1/4	OG159004506	Groove	7530	6650	53
15 x 9 x 11-1/4	OG159004507	Flat	8700	7700	60
15 x 9 x 11-1/4	OG159004508	Groove	8700	7700	60
15-1/2 x 5 x 10	OG1580040	Flat	4640	4110	39
15-1/2 x 5 x 10	OG158004001	Crown	4640	4110	39
15-1/2 x 5 x 10	OG158004002	Groove	4640	4110	39
15-1/2 x 6 x 10	OG1590040	Flat	5880	5210	46
15-1/2 x 6 x 10	OG159004001	Crown	5880	5210	46
15-1/2 x 6 x 10	OG159004002	Groove	5880	5210	46
16 x 5 x 10-1/2	OG1680042	Flat	4760	4200	40
16 x 5 x 10-1/2	OG168004201	Crown	4760	4200	40
16 x 5 x 10-1/2	OG168004202	Groove	4760	4200	40
16 x 6 x 10-1/2	OG1690042	Flat	6040	5330	48
16 x 6 x 10-1/2	OG169004201	Crown	6040	5330	48
16 x 6 x 10-1/2	OG169004204	Groove	6040	5330	48
16 x 7 x 10-1/2	OG169004203	Flat	7320	6470	57
16 x 7 x 10-1/2	OG169004204	Groove	7320	6470	57
16-1/4 x 4 x 11-1/4	OG1670045	Flat	3560	3140	32
16-1/4 x 4 x 11-1/4	OG167004501	Crown	3560	3140	32
16-1/4 x 5 x 11-1/4	OG1680045	Flat	4800	4250	40
16-1/4 x 5 x 11-1/4	OG168004501	Crown	4800	4250	40
16-1/4 x 5 x 11-1/4	OG168004502	Groove	4800	4250	40
16-1/4 x 6 x 11-1/4	OG1690045	Flat	6050	5360	48
16-1/4 x 6 x 11-1/4	OG169004501	Crown	6050	5360	48
16-1/4 x 6 x 11-1/4	OG169004502	Groove	6050	5360	48
16-1/4 x 7 x 11-1/4	OG169004503	Flat	7300	6450	56
16-1/4 x 7 x 11-1/4	OG169004504	Groove	7300	6450	56
18 x 5 x 12-1/8	OG1880049	Flat	5170	4590	43
18 x 5 x 12-1/8	OG188004901	Crown	5170	4590	43
18 x 6 x 12-1/8	OG1890049	Flat	6610	5850	52
18 x 6 x 12-1/8	OG189004901	Crown	6610	5850	52
18 x 7 x 12-1/8	OG189004902	Flat	8040	7110	63
18 x 7 x 12-1/8	OG189004903	Groove	8040	7110	63
18 x 8 x 12-1/8	OG189004904	Flat	9470	8380	71
18 x 8 x 12-1/8	OG189004905	Groove	9470	8380	71
18 x 9 x 12-1/8	OG189004906	Flat	10900	9660	82
18 x 9 x 12-1/8	OG189004907	Groove	10900	9660	82
18 x 4 x 14	OG1870056	Flat	3850	3400	32
18 x 4 x 14	OG187005601	Crown	3850	3400	32
18 x 5 x 14	OG1880056	Flat	5070	4480	40
18 x 5 x 14	OG188005601	Crown	5070	4480	40
18 x 7 x 14	OG1890056	Flat	7530	6650	58
18 x 7 x 14	OG189005601	Groove	7530	6650	58

OG Premium Quality Press-On Mini Polyurethane



Polyurethane tires will reduce operating cost because the high wear resistance of this material minimizes replacement. Polyurethane offers easier rollability, higher wear resistance, and greater capacity than rubber. Use press-on polyurethane as an alternative to standard mold-on polyurethane when greater cushioning or speed is involved.

FEATURES

- **Wheel Face:** Flat
- **Finish:** Green tread on grey hub
- **Temperature Range:** -40°F to +180°F
- **Hardness:** 95 Shore A

WHEEL OPTIONS

- Note: Select bearings featured are recommended for standard applications. For special applications or alternate bearings consult factory. See bearing information on page 13
- For customization & special application options, please consult factory

Wheel Diameter (Inches)	Tread Width (Inches)	Tire ID, Core OD (Inches)	Capacity (Lbs) (Ride for manual operation)	Hub Length (Inches)	Bore ID (Inches)	Bearing ID (Inches)	Approx. Wt. (Lbs)	Wheel Number Roller Bearing (01)	Wheel Number Over Spacers (09)
Press-on Mini Polyurethane (OG)									
5	4	3	2240	4-1/4	1-15/16	1-1/4	10	OG057012001	
5	4	3	2240	4-1/2	2	1	10		OG057091601
5	5	3	2800	5-1/4	1-15/16	1-1/4	13	OG058012001	
5	5	3	2800	5-1/2	2	1	13		OG058091601
6	4	4	2990	4-1/4	1-15/16	1-1/4	18-1/2	OG067012001	
6	4	4	2990	4-1/2	2	1	18-1/2		OG067091601
6	5	4	3700	4-1/4	1-15/16	1-1/4	20	OG068012001	
6	5	4	3700	5-1/2	2	1	20		OG068091601
6	6	4	4400	6-1/2	2	1	23		OG069091601
7	4	5	3040	4-1/2	2	1	22		OG077091601
7	5	5	3800	5-1/2	2	1	27-1/2		OG078091601
7	6	5	4550	6-1/2	2-7/16	1-1/4	33		OG079092001
8	3	6	2640	3-1/2	1-15/16	3/4	18		OG085091201
8	4	6	3670	4-1/2	2	1	20		OG087091601
8	5	6	4590	5-1/2	2-7/16	1-1/4	25		OG088092001
8	6	6	5500	6-1/2	2-7/16	1-1/4	36		OG089092001
10	3	8	3000	3-1/2	1-15/16	3/4	26		OG105091201
10	4	8	4000	4-1/2	2-7/16	1	31		OG107091601
10	5	8	5000	5-1/2	2	1	41		OG108091601
10	6	8	6000	6-1/2	2-7/16	1-1/4	64		OG109092001
10-1/2	3	8	3300	3-1/2	1-15/16	3/4	27		OG105091202
10-1/2	4	8	4400	4-1/2	2-7/16	1	32-1/2		OG107091602
10-1/2	5	8	5500	5-1/2	2-11/32	1-1/4	43		OG108092001
10-1/2	6	8	6600	6-1/2	2-7/16	1-1/4	66		OG109092002

POLYURETHANE PRESS-ON & V-GROOVE • UP TO 6500

XV Premium Quality Polyurethane V-Groove

Made in the USA



Wheel face and "V"-groove are machined from heavy duty polyurethane. A relief groove at the base of the "V" tends to equalize the load to each face of the angle track when in operation. Wheel face and bore are machined for concentricity to proper tracking. These wheels can be used not only on track but flat surfaces as well.

FEATURES

- **Wheel Face:** V-groove
- **Finish:** Green
- **Temperature Range:** -40°F to +180°F
- **Hardness:** 60 Shore D

WHEEL OPTIONS

- Note: Select bearings featured are recommended for standard applications. For special applications or alternate bearings consult factory. See bearing information on page 11
- For customization & special application options, please consult factory

Wheel Diameter (Inches)	Tread Width (Inches)	Capacity (Lbs) (Ride for manual operation)	Hub Length (Inches)	Bore ID (Inches)	Bearing ID (Inches)	Groove Width "A" (Inches)	Groove Depth "B" (Inches)	Approx. Wt. (Lbs)	Wheel Number Roller Bearing (02)
Polyurethane V-Groove (XV)									
4	2	300	2-3/16	1-3/16	3/4	7/8	7/16	1	XV042012
5	2	300	2-3/16	1-3/16	3/4	7/8	7/16	1-1/2	XV052012
6	2	300	2-3/16	1-3/16	3/4	7/8	7/16	1-3/4	XV062012
8	2	300	2-3/16	1-3/16	3/4	7/8	7/16	2-3/4	XV082012

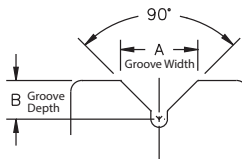

Letters match to chart descriptions



Please note: Track alignment is critical when utilizing v-groove wheels.

RUBBER TREAD WHEELS

Pneumatic Wheels

 Black Pneumatic (SF).....	167
 Grey Pneumatic (SG).....	167
 Pneumatic Hand Truck (SO).....	168



Semi-Pneumatic Wheels

 Semi-Pneumatic Hand Truck (SN).....	168
 Black Monoprene Semi-Pneumatic (SZ).....	169
 Grey Monoprene Semi-Pneumatic (SV).....	169



Never Flat Wheels

 Never-Flat (NF).....	170
---	-----

Rubber on Polypropylene Wheels

 Ultimate X-tra Soft Flat (XS).....	171
 Ultimate X-tra Soft Round (XR).....	172



Mold-on Rubber on Cast Iron Wheels

 Heavy Duty Mold-On Rubber on Cast Iron Core (MH).....	173
 Mold-On Rubber on Cast Iron Core (MR).....	173-174

Mold-on Rubber on Aluminum Wheels

 Mold-On Rubber on Die Cast Aluminum (MD).....	175
---	-----

Neoprene on Aluminum Wheels

 Neoprene on Aluminum Flat (MG).....	176
 Neoprene on Aluminum Round (NP).....	176

Solid Rubber Wheels

 Solid Rubber (RR).....	175
--	-----

Press-on Rubber Wheels

 Press-on Rubber (OA).....	177
--	-----

SF Premium Quality Black Pneumatic



Full Pneumatic (SF) are recommended for the greatest possible protection to both loads and floors. If you transport fragile materials or parts, or if you move delicate instruments over rough floors, you should consider a pneumatic tire. Full pneumatics cushion the load on air, just like an automobile. They must be properly inflated as indicated in wheel table. These tires can be filled with urethane foam to make them deflation proof, but foam has no effect on capacity. Suitable for extended service.

FEATURES

- Black Pneumatic tires feature non-marking floor protection
- Full pneumatics cushion the load on air, just like an automobile tire
- Smoother ride over rough floors
- Load capacities up to 3630 lbs per tire
- Wheels can be filled with urethane foam to make them deflation proof, but foam has no effect on capacity ... consult Albion for additional information

Wheel Diameter (Inches)	Tire Size/Type (Inches)	Capacity (Lbs) (Based on manual operation)	Ply Rating	Hub Length (Inches)	Air Pressure (PSI)	Bearing ID (Inches)	Approx. Wt. (Lbs)	Wheel Number Ball Bearing (27)	Wheel Number Roller (01)	Wheel Number Tapered (09)
Black Pneumatic (SF)										
8	2	210	4	2-7/16	50	1/2	3	SF0822708*		
8.6	2.50/4	220	4	2-3/4	50	3/4	3	SF0842708*	SF0840112	
8.6	2.50/4	220	4	3	50	1/2	3			
9.0	2.80/4	295	4	3-1/2	50	3/4	4-1/4	SF0852708*	SF0850112	
9.0	2.80/4	295	4	3-1/2	50	1/2	4-1/4			
10.9	4.10/4	350	4	3-1/2	50	3/4	5-1/2	SF1062708*	SF1060112	
10.9	4.10/4	350	4	3-1/2	50	1/2	5-1/2			
13.0	4.10/6	445	4	4-1/2	50	1	6-1/4	SF1272712	SF1270116	
13.0	4.10/6	445	4	4-1/2	50	3/4	6-1/4			
13.0	4.10/6	445	4	4-1/2	50	1	10-1/4			SF1270916
14.6	5.30/6	785	4	4-1/2	65	1	9	SF1482712	SF1480116	
14.6	5.30/6	785	4	4-1/2	65	3/4	9			
16.2	4.80/8	1300	6	6	90	1	16			SF1680916
16.3	4.80/8	1000	4	4-1/2	70	1-1/4	12		SF1680120	
18.4	5.70/8	1170	4	4-1/2	60	1-1/4	15		SF1890120	
19.0	5.70/8	1530	6	6-1/2	75	1	25			SF1890916
21.0	6.90/9	2420	10	7	100	1-1/4	37-1/2			SF2190920
23.5	6.50/10	2775	10	6	100	1-1/4	38			SF2390920
25.7	7.50/10	3630	10	9	95	1-1/4	40			SF2590920

*Precision bearings now available. Replacement parts now available, consult factory.

SG Premium Quality Grey Pneumatic



See SF description above.

FEATURES

- Grey Pneumatic tires feature non-marking floor protection
- Full pneumatics cushion the load on air, just like an automobile tire
- Smoother ride over rough floors
- Load capacities up to 350 lbs per tire
- Wheels can be filled with urethane foam to make them deflation proof, but foam has no effect on capacity ... consult Albion for additional information



Wheel Diameter (Inches)	Tire Size/Type (Inches)	Capacity (Lbs) (Based on manual operation)	Hub Length (Inches)	Bearing ID (Inches)	Approx. Wt. (Inches)	Ply Rating	Air Pressure (PSI)	Bearing Type	Wheel Number
Grey Pneumatic (SG) 2" Tread Width									
8	2	210	2-7/16	1/2	3	4	50	Precision Ball	SG0822808

Wheel Diameter (Inches)	Tire Size/Type (Inches)	Capacity (Lbs) (Based on manual operation)	Hub Length (Inches)	Bearing ID (Inches)	Approx. Wt. (Inches)	Ply Rating	Air Pressure (PSI)	Bearing Type	Wheel Number
Grey Pneumatic (SG) 2.50" to 4.10" Tread Width									
8.6	2.50/4	220	2-3/4	3/4	3	4	30	Roller	SG0840112
8.6	2.50/4	220	3 1/2	1/2	4	4	30	Precision Ball	SG0842808
9	2.80/4	295	3-1/2	3/4	4	4	50	Roller	SG0850112
9	2.80/4	295	3-1/2	1/2	4-1/4	4	50	Precision Ball	SG0852808
10.9	4.10/4	350	3-1/2	3/4	5-1/2	4	50	Roller	SG1060112
10.9	4.10/4	350	3-1/2	1/2	5-1/2	4	50	Precision Ball	SG1062808

S0 Pneumatic Hand Truck



This 4-ply rating tire with offset hub is the perfect answer for all your hand truck replacement needs.

FEATURES

- Black Pneumatic tires feature non-marking floor protection
- Full pneumatics cushion the load on air, just like an automobile tire
- Smoother ride over rough floors
- Load capacities up to 350 lbs per tire
- Wheels can be filled with urethane foam to make them deflation proof, but foam has no effect on capacity ... consult Albion for additional information

Wheel Diameter (Inches)	Tire Size/Type (Inches)	Capacity (Lbs) (Rated for manual operation)	Ply Rating	Hub Length (Inches)	Air Pressure (PSI)	Bearing ID (Inches)	Approx. Wt. (Lbs)	Wheel Number Ball Bearing (27)	Wheel Number Roller (01)	Wheel Number Precision Ball (28)
Pneumatic Hand Truck Tire (S0)										
10.5	4.10/4	350	4	2-1/4 Offset	50	5/8	2	S01062710	S01060110	S01062810

SN Semi-Pneumatic Hand Truck



These shock absorbing pneumatic wheels have no inflation problems, because they are not pressurized. All bearings are pressure lubricated, except the 6" diameter wheels, which must be lubricated through the hollow axle. Wheel core can be dark grey or white depending on size ordered.

FEATURES

- Black Pneumatic tires feature non-marking floor protection
- Semi-pneumatics cushion ... no need to refill air pressure
- Smoother ride over rough floors
- Load capacities up to 540 lbs per tire

Wheel Diameter (Inches)	Tire Size/Type (Inches)	Capacity (Lbs) (Rated for manual operation)	Hub Length (Inches)	Bearing ID (Inches)	Approx. Wt. (Lbs)	Wheel Number Ball Bearing (27)	Wheel Number Roller (01)
Semi-Pneumatic Hand Truck Tire (SN)							
6.2	2.00EHS	200	2-1/4	3/4	3	SN0622708	SN0620112
6.2	2.00EHS	200	2-1/2	1/2	3		
8.6	2.50EHS	350	3	3/4	5-3/4	SN0842708	SN0840112
8.6	2.50EHS	350	3	1/2	5-3/4		
10.0	2.75EHS	350	3-1/4	3/4	7-1/4	SN1042708	SN1040112
10.0	2.75EHS	350	3-1/4	1/2	7-1/4		
12.1	3.00EHS	540	3-1/2	3/4	13-1/2	SN1252708	SN1250112
12.1	3.00EHS	540	3-1/2	1/2	13-1/2		

SZ

Monoprene Semi-Pneumatic



The SZ wheel provides you with all the benefits of a pneumatic tire, without the hassle of getting a flat. These maintenance free wheels, constructed of solid monoprene material, which rejects debris and will not go flat, offer the same great features of a pneumatic wheel.

FEATURES

- **Wheel Face:** Traction tread
- **Finish:** Zinc plated hub
- **Temperature Range:** -40°F to +180°F
- **Hardness:** 65-75 Shore A

WHEEL OPTIONS

- Note: Select bearings featured are recommended for standard applications. For special applications or alternate bearings consult factory. See bearing information on page 13
- For customization & special application options, please consult factory

Wheel Diameter (Inches)	Tire Size/Type (Inches)	Capacity (Lbs) (Based for manual operation)	Hub Length (Inches)	Bearing ID (Inches)	Tread Style	Wheel Number Precision Ball Bearing (28)
Black Monoprene Semi-Pneumatic (SZ)						
6	2	250	2-7/16	1/2	Lug	SZ0622808
8	2	280	2-7/16	1/2	Lug	SZ0822808
10	3-1/2	440	3-1/4	1/2	Ribbed	SZ1062808
10	3-1/2	440	2-1/4	5/8	Ribbed	SZ1062810H

SV

Monoprene Semi-Pneumatic



The SV wheel provides you with all the benefits of a pneumatic tire, without the hassle of getting a flat. These maintenance free wheels, constructed of solid monoprene material, which rejects debris and will not go flat, offer the same great features of a pneumatic wheel.

FEATURES

- **Wheel Face:** Traction tread
- **Finish:** Zinc plated hub
- **Temperature Range:** -40°F to +180°F
- **Hardness:** 65-75 Shore A

WHEEL OPTIONS

- Note: Select bearings featured are recommended for standard applications. For special applications or alternate bearings consult factory. See bearing information on page 13
- For customization & special application options, please consult factory

Wheel Diameter (Inches)	Tire Size/Type (Inches)	Capacity (Lbs) (Based for manual operation)	Hub Length (Inches)	Bearing ID (Inches)	Tread Style	Wheel Number Precision Ball Bearing (28)
Grey Monoprene Semi-Pneumatic (SV)						
6	2	250	2-7/16	1/2	Lug	SV0622808
8	2	280	2-7/16	1/2	Lug	SV0822808
10	3-1/2	440	3-1/4	1/2	Ribbed	SV1062808
10	3-1/2	440	2-1/4	5/8	Ribbed	SV1062810H

NF Never-Flat Tires



Never-Flat (NF) is recommended for the greatest possible protection to both loads and floors. Perfect replacement tire for pneumatic or semi-pneumatic applications. This solid urethane tire has similar rollability characteristics as a pneumatic tire... but they never go flat. Optional colors and caster configurations available, consult factory. Replacement parts available: 8" grey wheel and 10" black wheel.



FEATURES

- Heavy duty 350 pound load capacity!
- Looks and performs similar to pneumatic wheels, but without the hassles of air pressure maintenance and flat tire repair
- Reduces maintenance time and expense
- Closed cell expanded foam construction resists water absorption (unlike others currently in the marketplace)
- Sawtooth tread for easy maneuverability and traction (radial tread on 8" model)
- Quiet, smooth operation
- Non-marking for superior floor protection
- Rolls over obstacles with ease and absorbs shock to protect cargo
- Zerk fittings

Wheel Diameter (Inches)	Tire Size (Inches)	Capacity (Lbs) (Based for normal operation)	Hub Length (Inches)	Hub Description	Bearing ID (Inches)	Approx. Wt. (Lbs)	Wheel Number Prec. Ball Bearing (28)
Grey Never-Flat (NF)							
8	2-1/2	300	2-1/4	Offset 1-Piece Hub	1/2	2-1/4	NF0852808
8	2-1/2	300	2-1/4	Offset 1-Piece Hub	5/8	2-1/4	NF0852810
8	2-1/2	300	3	Centered 1-Piece Hub	1/2	3	NF0852808C
8	2-1/2	300	2-1/4	Offset 3-Piece Hub	1/2	2-1/4	NF0852808T
8	2-1/2	300	2-1/4	Offset 3-Piece Hub	5/8	2-1/4	NF0852810T
8	2-1/2	300	3	Centered 3-Piece Hub	1/2	3	NF0852808CT
8	2-1/2	300	3	Centered 3-Piece Hub	5/8	3	NF0852810CT

Black Never-Flat (NF)							
10	3-1/2	350	2-1/4	Offset 1-Piece Hub	1/2	5	NF1062808
10	3-1/2	350	2-1/4	Offset 1-Piece Hub	5/8	5	NF1062810
10	3-1/2	350	2-1/4	Offset 3-Piece Hub	1/2	5	NF1062808T
10	3-1/2	350	2-1/4	Offset 3-Piece Hub	5/8	5	NF1062810T
10	3-1/2	350	3-1/2	Centered 1-Piece Hub	5/8	5	NF1062810C
10	3-1/2	350	3-1/2	Centered 3-Piece Hub	1/2	5	NF1062808CT
10	3-1/2	350	3-1/2	Centered 3-Piece Hub	5/8	5	NF1062810CT

10" precision ball and roller bearing models available, roller bearing ID is 3/4".
For precision ball models change 27 to 28. For roller bearing models change 27 to 01.

Replacement 10" diameter tire less hub available, specify NF1060022.
Replacement parts available.



XS



Premium Quality

Ultimate X-tra Soft Rubber

The Ultimate X-tra soft rubber wheels offer the ultimate in ergonomic ease. Whether it's durability, quiet operation, or rollability, these wheels can answer your every application need.

FEATURES

- **Wheel Face:** Moderate crown
- **Finish:** Non-marking grey tread on grey core
- **Temperature Range:** -45°F to +180°F
- **Hardness:** 65-75 Shore A

WHEEL OPTIONS

- Prevenz™ Antimicrobial wheel available, specify **PREV**
- For customization, special applications or alternate bearings, consult factory



	Wheel Diameter (Inches)	Tread Width (Inches)	Capacity (Lbs) (Based on manual operation)	Hub Length (Inches)	Bore ID (Inches)	Bearing ID (Inches)	Approx. Wk. (Lbs)	Wheel Bearing	Wheel Number
Xtra-Soft Flat Grey Tread (XS) (Light Duty)									
3	1-1/4	200	1-1/2	1-1/16	1/2	5/16		Delrin	XS0305108
3	1-1/4	200	1-1/2	1-1/16	3/8	5/16		Annular Ball	XS0303106
3-1/2	1-1/4	250	1-1/2	1-1/16	1/2	5/16		Delrin	XS03X5108
3-1/2	1-1/4	250	1-1/2	1-1/16	3/8	5/16		Annular Ball	XS03X3106
4	1-1/4	300	1-1/2	1-1/16	1/2	3/8		Delrin	XS0405108
4	1-1/4	300	1-1/2	1-1/16	3/8	3/8		Annular Ball	XS0403106
5	1-1/4	325	1-1/2	1-1/16	1/2	3/4		Delrin	XS0505108
5	1-1/4	325	1-1/2	1-1/16	3/8	3/4		Annular Ball	XS0503106
6	1-1/4	325	1-1/2	1-1/16	1/2	3/4		Delrin	XS0605108
6	1-1/4	325	1-1/2	1-1/16	3/8	3/4		Annular Ball	XS0603106

Xtra-Soft Flat Grey Tread (XS) (Medium Heavy Duty)									
4	2	400	2-3/16	1-3/16	3/4	1		Delrin	XS0425112
4	2	400	2-3/16	1-3/16	3/4	1		Roller	XS0420112~
4	2	400	2-7/16	1-9/16	1/2	1		Precision Ball	XS0422808*
5	2	500	2-3/16	1-3/16	3/4	1-1/8		Delrin	XS0525112
5	2	500	2-3/16	1-3/16	3/4	1-1/8		Roller	XS0520112~
5	2	500	2-7/16	1-9/16	1/2	1-1/8		Precision Ball	XS0522808*
6	2	600	2-3/16	1-3/16	3/4	1-3/8		Delrin	XS0625112
6	2	600	2-3/16	1-3/16	3/4	1-3/8		Roller	XS0620112~
6	2	600	2-7/16	1-9/16	1/2	1-3/8		Precision Ball	XS0622808*
8	2	675	2-3/16	1-3/16	3/4	2-3/8		Delrin	XS0825112
8	2	675	2-3/16	1-3/16	3/4	2-3/8		Roller	XS0820112~
8	2	675	2-7/16	1-9/16	1/2	2-3/8		Precision Ball	XS0822808*

Xtra-Soft Flat Black Tread (XS) (Center Hub)									
8	1-1/2	350	2.32	1-3/8	1/2	3		Industrial Ball	XS0812708
8	1-1/2	350	2	1-3/16	N/A	3		Plain	XS081001901

Xtra-Soft Light Duty Conductive (XY)									
3	1-1/4	200	1-1/2	1-1/16	3/8	5/16		Annular Ball	XY0303106
3-1/2	1-1/4	250	1-1/2	1-1/16	3/8	5/16		Annular Ball	XY03X3106
4	1-1/4	300	1-1/2	1-1/16	3/8	3/8		Annular Ball	XY0403106
5	1-1/4	325	1-1/2	1-1/16	3/8	3/4		Annular Ball	XY0503106
6	1-1/4	325	1-1/2	1-1/16	3/8	3/4		Annular Ball	XY0603106

Xtra-Soft Medium Heavy Duty Conductive (XY)									
4	2	350	2-3/16	1-3/16	3/4	1		Roller	XY0420112~
4	2	350	2-7/16	1-9/16	1/2	1		Precision Ball	XY0422808*
5	2	375	2-3/16	1-3/16	3/4	1-1/8		Roller	XY0520112~
5	2	375	2-7/16	1-9/16	1/2	1-1/8		Precision Ball	XY0522808*
6	2	600	2-3/16	1-3/16	3/4	1-3/8		Roller	XY0620112~
6	2	500	2-7/16	1-9/16	1/2	1-3/8		Precision Ball	XY0622808*
8	2	675	2-3/16	1-3/16	3/4	2-3/8		Roller	XY0820112~
8	2	500	2-7/16	1-9/16	1/2	2-3/8		Precision Ball	XY0822808*

~ Wheels are complete with spanner bushing and nylon sealed retaining washer.
*Precision Sealed Bearings and top hats.

RUBBER ON POLYPROPYLENE • UP TO 675

Prevenz™ Antimicrobial



The EPA registered and FDA compliant antimicrobial additive used in Prevenz™ wheels is designed to suppress the growth of a variety of destructive and odor causing microbes including bacteria, molds, mildew and fungi. These wheels are suitable for a variety of applications including medical equipment, food equipment, pharmaceutical, chemical, meat & poultry, processing plants and more. To order add "PREV" to end of caster number.

XR

Q Premium Quality
Ultimate X-tra
Soft Rubber

The Ultimate X-tra soft rubber wheels offer the ultimate in ergonomic ease. Whether it's durability, quiet operation, or rollability, these wheels can answer your every application need.

FEATURES

- **Wheel Face:** Round tread
- **Finish:** Non-marking grey tread on grey core.
- **Temperature Range:** -45°F to +180°F
- **Hardness:** 65-75 Shore A (unless otherwise specified)

WHEEL OPTIONS

- Prevenz™ Antimicrobial wheel available, specify **PREV**
- For customization, special applications or alternate bearings consult factory



Wheel Diameter (Inches)	Tread Width (Inches)	Capacity (Lbs) (Based on manual operation)	Hub Length (Inches)	Bore ID (Inches)	Bearing ID (Inches)	Approx. Wt. (Lbs)	Wheel Bearing	Wheel Number
Xtra-Soft Round Grey Tread (XR) (Light Duty)								
3	1-1/4	200	1-1/2	1-1/16	3/8	5/16	Precision Ball	XR0302806
3-1/2	1-1/4	250	1-1/2	1-1/16	3/8	5/16	Precision Ball	XR03X2806
4	1-1/4	300	1-1/2	1-1/16	3/8	3/8	Precision Ball	XR0402806
5	1-1/4	325	1-1/2	1-1/16	3/8	3/4	Precision Ball	XR0502806

Wheel Diameter (Inches)	Tread Width (Inches)	Capacity (Lbs) (Based on manual operation)	Hub Length (Inches)	Bore ID (Inches)	Bearing ID (Inches)	Approx. Wt. (Lbs)	Wheel Bearing	Wheel Number
Xtra-Soft Round Grey Tread (XR) (Medium Heavy Duty)								
6	2	450	2-3/16	1-3/16	3/4	1-3/8	Delrin	XR0625112
6	2	450	2-3/16	1-3/16	3/4	1-3/8	Roller	XR0620112~
6	2	450	2-7/16	1-9/16	1/2	1-3/8	Precision Ball	XR0622808*
8	2	600	2-3/16	1-3/16	3/4	2-3/8	Delrin	XR0825112
8	2	600	2-3/16	1-3/16	3/4	2-3/8	Roller	XR0820112*
8	2	600	2-7/16	1-9/16	1/2	2-3/8	Precision Ball	XR0822808*

Wheel Diameter (Inches)	Tread Width (Inches)	Capacity (Lbs) (Based on manual operation)	Hub Length (Inches)	Bore ID (Inches)	Bearing ID (Inches)	Approx. Wt. (Lbs)	Wheel Bearing	Wheel Number
Xtra-Soft Round Grey Tread (XR) (Heavy Duty)								
10	2-1/2	850	3-1/2	2-7/16	3/4	3	Precision Ball	XR1042812*
10	2-1/2	850	3-1/4	1-15/16	1	3	Roller	XR1040116
10	2-1/2	850	3-1/4	1-15/16	1	1	Delrin	XR1045116

Tread Hardness is 50-60 Shore A.
 ~ Wheels are complete with spanner bushing & nylon sealed retaining washers.
 * Precision sealed bearings and top hats.

Wheel Diameter (Inches)	Tread Width (Inches)	Capacity (Lbs) (Based on manual operation)	Hub Length (Inches)	Bore ID (Inches)	Bearing ID (Inches)	Approx. Wt. (Lbs)	Wheel Bearing	Wheel Number
Xtra-Soft Round Black Tread (XR) (Hand Truck Offset Hub)								
8	2	250	2-1/4	1-3/8	1/2	2	Precision Ball	XR0822808H
8	2	250	2-1/4	1-3/8	5/8	2	Precision Ball	XR0822810H
10	2	250	2-1/4	1-3/8	1/2	3	Precision Ball	XR1022808H
10	2	250	2-1/4	1-3/8	5/8	3	Precision Ball	XR1022810H

Tread Hardness is 50-60 Shore A.
 ~ Wheels are complete with spanner bushing & nylon sealed retaining washers.
 * Precision sealed bearings and top hats.

Wheel Diameter (Inches)	Tread Width (Inches)	Capacity (Lbs) (Based on manual operation)	Hub Length (Inches)	Bore ID (Inches)	Bearing ID (Inches)	Approx. Wt. (Lbs)	Wheel Bearing	Wheel Number
Xtra-Soft Round Conductive (XZ)								
6	2	450	2-3/16	1-3/16	1/2	1-3/8	Annular Ball	XZ0623108
6	2	450	2-3/16	1-3/16	3/4	1-3/8	Roller	XZ0620112~
6	2	450	2-7/16	1-9/16	1/2	1-3/8	Precision Ball	XZ0622808*
8	2	600	2-3/16	1-3/16	1/2	2-3/8	Annular Ball	XZ0823108
8	2	600	2-3/16	1-3/16	3/4	2-3/8	Roller	XZ0820112*
8	2	500	2-7/16	1-9/16	1/2	2-3/8	Precision Ball	XZ0822808*

~ Wheels are complete with spanner bushing & nylon sealed retaining washers.
 * Precision sealed bearings and top hats.

Prevenz™ Antimicrobial

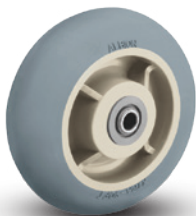

The EPA registered and FDA compliant antimicrobial additive used in Prevenz™ wheels is designed to suppress the growth of a variety of destructive and odor causing microbes including bacteria, molds, mildew and fungi. These wheels are suitable for a variety of applications including medical equipment, food equipment, pharmaceutical, chemical, meat & poultry, processing plants and more. To order add "PREV" to end of caster number.

MH



Premium Quality

Heavy Duty Mold-On Rubber on Iron Core



Heavy Duty cushion rubber treads are vulcanized to cast iron cores. The harder rubber tread still provides a cushion effect to the load and excellent floor protection. These wheels are highly shock absorbing and provide quiet operation, while dampening vibration.

FEATURES

- **High Tensile Strength**
- **Wheel face:** Moderate crown
- **Finish:** Black tread on iron core
- **Temperature Range:** -40°F to +180°F
- **Hardness:** 90-95 Shore A

WHEEL OPTIONS

- Note: Select bearings featured are recommended for standard applications. For special applications or alternate bearings consult factory. See bearing information on page 13
- For customization & special application options, please consult factory

Wheel Diameter (Inches)	Tread Width (Inches)	Capacity (Lbs) (Rated for normal operation)	Hub Length (Inches)	Bore ID (Inches)	Bearing ID (Inches)	Approx. Wt. (Lbs)	Wheel Number Roller Bearing (01, 05, 07)
3-1/4	1-1/2	340	1-5/8	1-3/16	3/4		MH0310112~
4	1-1/2	400	1-5/8	1-3/16	3/4		MH0410112~
5	1-1/2	560	1-5/8	1-3/16	1/2		MH0510108
5	1-1/2	560	1-5/8	1-3/16	5/8		MH0510110
5	1-1/2	560	1-5/8	1-3/16	3/4		MH0510112~
5	2	700	2-3/16	1-3/16	1/2		MH0520108
5	2	700	2-3/16	1-3/16	5/8		MH0520110
5	2	700	2-3/16	1-3/16	3/4		MH0520112~
6	2	820	2-3/16	1-3/16	1/2		MH0620108
6	2	820	2-3/16	1-3/16	5/8		MH0620110
6	2	820	2-3/16	1-3/16	3/4		MH0620112~
7	1-5/8	760	2	1-3/16	5/8		MH0710110
7	1-5/8	760	2	1-3/16	3/4		MH0710112~
8	2	1000	2-3/16	1-3/16	5/8		MH0820110
8	2	1000	2-3/16	1-3/16	3/4		MH0820112~
8	2	1000	2-3/16	1-3/16	7/8		MH0820114
8	2	1000	2-3/16	1-15/16	1		MH0820116
8	2-1/2	1300	2-3/4	1-3/16	7/8		MH0840714
8	2-1/2	1300	2-3/4	1-15/16	1		MH0840516
10	2-1/2	1500	2-3/4	1-3/16	7/8		MH1040714
10	2-1/2	1500	2-3/4	1-15/16	1		MH1040516
10	2-1/2	1500	2-3/4	1-15/16	1-1/2		MH1040524
10	3	1800	3-1/4	1-15/16	1		MH1050116
12	2-1/2	1700	2-3/4	1-15/16	1		MH1240516
12	2-1/2	1700	2-3/4	1-15/16	1-1/4		MH1240520
16	3	2500	3	2-7/16	1-1/4		MH1650120

~ Wheels are complete with spanner bushing and nylon sealed retaining/thrust washer.

MR



Premium Quality

Mold-On Rubber on Iron Core



Cushion rubber treads are vulcanized to cast iron cores. The soft rubber tread affords a cushion effect to the load. These wheels are highly shock absorbing and provide quiet operation, while dampening vibration.

FEATURES

- **High Tensile Strength**
- **Wheel face:** Moderate crown
- **Finish:** Black tread on black enamel core
- **Temperature Range:** -40°F to +180°F
- **Hardness:** 70-85 Shore A

WHEEL OPTIONS

- For neoprene on iron core, consult factory.
- Note: Select bearings featured are recommended for standard applications. For special applications or alternate bearings consult factory. See bearing information on page 13
- For customization & special application options, please consult factory

Wheel Diameter (Inches)	Tread Width (Inches)	Capacity (Lbs) (Rated for normal operation)	Hub Length (Inches)	Bore ID (Inches)	Bearing ID (Inches)	Approx. Wt. (Lbs)	Wheel Number Tapered Roller (09)
4	1-1/2	250	1-5/8	1-3/16	1/2	1-1/4	MR0410108
4	1-1/2	250	1-5/8	1-3/16	5/8	1-1/4	MR0410110
4	1-1/2^A	250	1-5/8	1-3/16	3/4	1-1/4	MR0410112~
4	2	300	2-3/16	1-3/16	1/2	1-1/2	MR0420108
4	2	300	2-3/16	1-3/16	5/8	1-1/2	MR0420110
4	2	300	2-3/16	1-3/16	3/4	1-1/2	MR0420112~
5	1-1/2	350	1-5/8	1-3/16	1/2	1-1/2	MR0510108
5	1-1/2	350	1-5/8	1-3/16	5/8	1-1/2	MR0510110
5	1-1/2^A	350	1-5/8	1-3/16	3/4	1-1/2	MR0510112~
5	2	450	2-3/16	1-3/16	1/2	2	MR0520108
5	2	450	2-3/16	1-3/16	5/8	2	MR0520110
5	2	450	2-3/16	1-3/16	3/4	2	MR0520112~
6	2	500	2-3/16	1-3/16	1/2	2-1/4	MR0620108
6	2	500	2-3/16	1-3/16	5/8	2-1/4	MR0620110
6	2	500	2-3/16	1-3/16	3/4	2-1/4	MR0620112~
6	2-1/2	700	3-1/4	1-15/16	1	10	MR0640116
6	2-1/2	700	2-3/4	1-15/16	1	9-1/4	MR0640516
6	2-1/2	700	2-3/4	1-3/16	3/4	6-1/4	MR0640712
6	2-1/2	700	3-1/2	1-15/16	3/4	9-1/2	
6	3	750	3-1/4	1-15/16	1	9-1/2	MR0650116
6	3	750	3-1/4	1-15/16	1-1/4	9-1/2	MR0650120
6	3	750	3-1/2	1-15/16	3/4	9-1/4	

~ Wheels are complete with spanner bushing and nylon sealed retaining/thrust washer.

^ 27/16" spanner and spacers included.

RUBBER ON IRON • UP TO 2500

MR



Premium Quality

Mold-On Rubber on Iron Core



MR wheels continued from previous page

Cushion rubber treads are vulcanized to cast iron cores. The soft rubber tread affords a cushion effect to the load. These wheels are highly shock absorbing and provide quiet operation, while dampening vibration.

FEATURES

- **High Tensile Strength**
- **Wheel face:** Moderate crown
- **Finish:** Black tread on black enamel core
- **Temperature Range:** -40°F to +180°F
- **Hardness:** 70-85 Shore A

WHEEL OPTIONS

- For neoprene on iron core, consult factory.
- Note: Select bearings featured are recommended for standard applications. For special applications or alternate bearings consult factory. See bearing information on page 13
- For customization & special application options, please consult factory

Moldon Rubber on Iron Core (MR)										Wheel Number Roller Bearing (01, 05, 07)	Wheel Number Tapered Roller Roller (09)	
Wheel Diameter (Inches)	Tread Width (Inches)	Capacity (Lbs) (Rate for manual operation)	Hub Length (Inches)	Bore ID (Inches)	Bearing ID (Inches)	Approx. Wt. (Lbs)						
7	2-1/2	800	2-3/4	1-15/16	1	9-1/2					MR0740516	
8	2	600	2-3/16	1-3/16	1/2	3-1/2					MR0820108	
8	2	600	2-3/16	1-3/16	3/4	6-1/3					MR0820112~	
8	2	600	2-3/16	1-3/16	5/8	3-1/2					MR0820110	
8	2	600	2-3/16	1-3/16	7/8	3-1/2					MR0820114	
8	2	600	2-3/16	1-15/16	1	4					MR0820116	
8	2-1/2	850	3-1/4	1-15/16	1	9-3/4					MR0840116	
8	2-1/2	850	3-1/4	1-15/16	1-1/4	9-3/4					MR0840120	
8	2-1/2	850	2-3/4	1-15/16	1	9-1/2					MR0840516	
8	2-1/2	850	2-3/4	1-3/16	3/4	8-1/2					MR0840712	
8	2-1/2	850	3-1/2	1-15/16	3/4	9-1/2						MR0840912
8	3	900	3-1/2	1-15/16	3/4	11-1/4						MR0850912
8	3	900	3-1/2	1-63/64	1	11-1/4						MR0850916
8	3	900	3-1/4	1-15/16	1-1/4	11-1/2					MR0850120	
10	2-1/2	950	2-3/4	1-3/16	3/4	12-1/4					MR1040712	
10	2-1/2	950	2-3/4	1-3/16	7/8	12-3/4					MR1040714	
10	2-1/2	950	3-1/4	1-15/16	1	13					MR1040116	
10	2-1/2	950	2-3/4	1-15/16	1	12-3/4					MR1040516	
10	2-1/2	950	3-1/4	1-15/16	1-1/4	13					MR1040120	
10	3	1000	3-1/2	1-15/16	3/4	14						MR1050912
10	3	1000	3-1/4	1-15/16	1	14-1/4					MR1050116	
10	3	1000	3-1/2	1-63/64	1	14						MR1050916
10	3	1000	3-1/4	1-15/16	1-1/4	14-1/4					MR1050120	
10	3	1000	3-1/2	2-21/64	1-1/4	14						MR1050920
10	4	1400	4-1/4	2-7/16	1-1/4	25-1/2					MR1070120	
10	4	1400	4-1/4	2-7/16	1-1/2	25-1/2					MR1070124	
10	4	1400	4-1/2	2-7/16	1	25						MR1070916
10	4	1400	4-1/2	2-7/16	1-1/4	25						MR1070920
12	2-1/2	950	3-1/4	1-15/16	1	16					MR1240116	
12	2-1/2	950	3-1/4	1-15/16	1-1/4	16					MR1240120	
12	2-1/2	950	2-3/4	1-15/16	1	15-1/2					MR1240516	
12	3	1200	3-1/4	1-15/16	1	19-1/4					MR1250116	
12	3	1200	3-1/4	1-15/16	1-1/4	19-1/4					MR1250120	
12	3	1200	3-1/2	1-15/16	3/4	19						MR1250912
12	3-1/2	1500	4-1/4	2-7/16	1-1/4	24					MR1260120	
12	3-1/2	1500	4-1/4	2-7/16	1-1/2	24					MR1260124	
12	3-1/2	1500	4-1/2	2-7/16	1	23						MR1260916
12	3-1/2	1500	4-1/2	2-7/16	1-1/4	23						MR1260920
12	4	1600	4-1/4	2-7/16	1-1/4	29-1/2					MR1270120	
12	4	1600	4-1/4	2-7/16	1-1/2	29-1/2					MR1270124	
12	4	1600	4-1/2	2-7/16	1	29						MR1270916
12	4	1600	4-1/2	2-7/16	1-1/4	29						MR1270920
14	2-1/2	1100	2-3/4	1-15/16	1	18					MR1440516	
14	2-1/2	1100	2-3/4	1-15/16	1-1/4	18					MR1440520	
14	3	1280	3-1/4	1-15/16	1	23-1/2					MR1450116	
14	3	1280	3-1/4	1-15/16	1-1/4	23-1/2					MR1450120	
16	3	1500	3-1/4	1-15/16	1	40					MR1650116	
16	3	1500	3-1/4	1-15/16	1-1/4	40					MR1650120	
16	4	2000	4-1/4	2-7/16	1-1/4	47-3/4					MR1670120	
16	4	2000	4-1/4	2-7/16	1-1/2	47-3/4					MR1670124	
16	5	2570	5-1/4	2-7/16	1-1/4	60-1/4					MR1680120	
16	5	2570	5-1/4	2-7/16	1-1/2	60-1/4					MR1680124	
16	5	2570	5-1/4	3-1/4	2	60-1/4					MR1680132	
18	3	1550	4-1/4	2-7/16	1-1/4	41-3/4					MR1850120	
18	3	1550	4-1/4	2-7/16	1-1/2	41-3/4					MR1850124	
18	5	2800	5-1/4	2-7/16	1-1/2	83-1/4					MR1880124	
18	5	2800	5-1/4	3-1/16	1-3/4	86					MR1880128	
18	5	2800	5-1/4	3-1/4	2	86					MR1880132	
20	3	1680	4-1/4	2-7/16	1-1/4	64					MR2050120	
20	3	1680	4-1/4	2-7/16	1-1/2	64					MR2050124	
20	5	3020	5-1/4	3-1/4	2	93					MR2080132	

~ Wheels are complete with spanner bushing and nylon sealed retaining/thrust washer.
 ^ 2 7/16" spanner and spacers included.

MD



Mold-On Rubber on Die Cast Aluminum



Cushion rubber treads are vulcanized to die cast aluminum core. The soft rubber tread affords a cushion effect to the load and excellent floor protection. These wheels are highly shock absorbing and provide quiet operation, while dampening vibration.

FEATURES

- **Wheel face:** Moderate crown
- **Finish:** Black on natural aluminum core
- **Temperature Range:** -40°F to +180°F
- **Hardness:** 80-83 Shore A

WHEEL OPTIONS

- Note: Select bearings featured are recommended for standard applications. For special applications or alternate bearings consult factory. See bearing information on page 13
- For customization & special application options, please consult factory

RR

Soft Rubber



Protect floors and quiet operation with our rubber wheels. Rubber is molded to harder rubber core.

FEATURES

- **Wheel Face:** Moderate crown
- **Finish:** Black
- **Temperature Range:** -40°F to +180°F
- **Hardness:** 75-85 Shore A

WHEEL OPTIONS

- **Solid Hard Rubber (RN)** available, consult factory; Hardness: 75 shore D
- Note: Select bearings featured are recommended for standard applications. For special applications or alternate bearings consult factory. See bearing information on page 13
- For customization & special application options, please consult factory

	Wheel Diameter (Inches)	Tread Width (Inches)	Capacity (Lbs) (Rated for manual operation)	Hub Length (Inches)	Bore ID (Inches)	Bearing ID (Inches)	Approx. Wt. (Lbs)	Wheel Number Roller Bearing (01)
Heavy Duty Mold-On Rubber on Aluminum Core (MD)								
4	1-1/2	250	1-5/8	1-3/16	1/2	1-1/4		MD0410108
4	1-1/2	250	1-5/8	1-3/16	5/8	1-1/4		MD0410110
4	1-1/2 [^]	250	1-5/8	1-3/16	3/4	1-1/4		MD0410112~
4	2	400	2-3/16	1-3/16	1/2	1-1/2		MD0420108
4	2	400	2-3/16	1-3/16	5/8	1-1/2		MD0420110
4	2	400	2-3/16	1-3/16	3/4	1-1/2		MD0420112~
5	1-1/2	300	1-5/8	1-3/16	1/2	1-1/2		MD0510108
5	1-1/2	300	1-5/8	1-3/16	5/8	1-1/2		MD0510110
5	1-1/2 [^]	300	1-5/8	1-3/16	3/4	1-1/2		MD0510112~
5	2	500	2-3/16	1-3/16	1/2	2		MD0520108
5	2	500	2-3/16	1-3/16	5/8	2		MD0520110
5	2	500	2-3/16	1-3/16	3/4	2		MD0520112~
6	2	550	2-3/16	1-3/16	1/2	2-1/4		MD0620108
6	2	550	2-3/16	1-3/16	5/8	2-1/4		MD0620110
6	2	550	2-3/16	1-3/16	3/4	2-1/4		MD0620112~
8	2	600	2-3/16	1-3/16	1/2	3-1/2		MD0820108
8	2	600	2-3/16	1-3/16	5/8	3-1/2		MD0820110
8	2	600	2-3/16	1-3/16	5/8	3-1/2		MD0820110
8	2	600	2-3/16	1-3/16	3/4	3-1/2		MD0820112~

~ Wheels are complete with spanner bushing and nylon sealed retaining/thrust washer.
[^] 27/16" spanner and spacers included.

	Wheel Diameter (Inches)	Tread Width (Inches)	Capacity (Lbs) (Rated for manual operation)	Hub Length (Inches)	Bore ID (Inches)	Bearing ID (Inches)	Approx. Wt. (Lbs)	Wheel Number Roller Bearing (01)	Wheel Number Plain Bore (41)
Solid Soft Rubber (RR)									
3	1-1/4	125	1-3/8	1-1/16	1/2	1/2		RR0300108	RR0304108
3-1/2	1-1/4	150	1-3/8	1-1/16	1/2	1/2			RR03X4108
4	1-1/4	150	1-3/8	1-1/16	1/2	3/4		RR0400108	RR0404108
4	1-1/2	170	1-5/8	1-3/16	1/2	1-1/4		RR0410108	
4	1-1/2	170	1-5/8	1-3/16	5/8	1-1/4		RR0410110	
4	1-1/2 [^]	170	1-5/8	1-3/16	3/4	1-1/4		RR0410112~	
4	2	220	2-3/16	1-3/16	1/2	1-1/2		RR0420108	
4	2	220	2-3/16	1-3/16	5/8	1-1/2		RR0420110	
4	2	220	2-3/16	1-3/16	3/4	1-1/2		RR0420112~	
5	1-1/4	175	1-3/8	1-1/16	1/2	1-1/2		RR0500108	RR0504108
5	1-1/2	240	1-5/8	1-3/16	1/2	1-3/4		RR0510108	
5	1-1/2	240	1-5/8	1-3/16	5/8	1-3/4		RR0510110	
5	1-1/2 [^]	240	1-5/8	1-3/16	3/4	1-3/4		RR0510112~	
5	2	325	2-3/16	1-3/16	1/2	2-1/2		RR0520108	
5	2	325	2-3/16	1-3/16	5/8	2-1/2		RR0520110	
5	2	325	2-3/16	1-3/16	3/4	2-1/2		RR0520112~	
6	1-1/2	270	1-5/8	1-3/16	1/2	2-3/4		RR0610108	
6	1-1/2	270	1-5/8	1-3/16	5/8	2-3/4		RR0610110	
6	1-1/2 [^]	270	1-5/8	1-3/16	3/4	2-3/4		RR0610112~	
6	2	350	2-3/16	1-3/16	1/2	3-1/2		RR0620108	
6	2	350	2-3/16	1-3/16	5/8	3-1/2		RR0620110	
6	2	350	2-3/16	1-3/16	3/4	3-1/2		RR0620112~	
8	1-1/2	360	1-5/8	1-3/16	1/2	4		RR0810108	
8	1-1/2 [^]	360	1-5/8	1-3/16	5/8	4		RR0810110	
8	1-1/2 [^]	360	1-5/8	1-3/16	3/4	4		RR0810112~	

~ Wheels are complete with spanner bushing and nylon sealed retaining thrust washer.
[^] 27/16" spanner and spacers included.

RUBBER ON ALUMINUM & SOLID • UP TO 600

MG



Premium Quality



Ergonomic

Neoprene on Aluminum

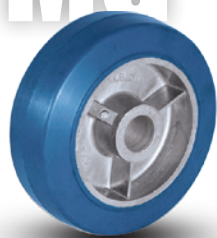

The MG wheel has a neoprene tread that is impervious to metal chips and screws, and has an extremely high chemical resistance. This wheel will perform well in contact with oils and chemicals; it can be used over a wide temperature range. The MG wheel is tough and is designed to handle heavy loads.

FEATURES

- **Wheel face:** Moderate crown
- **Finish:** Blue on aluminum core
- **Temperature Range:** -22°F to +220°F
- **Hardness:** 80 Shore A

WHEEL OPTIONS

- Note: Select bearings featured are recommended for standard applications. For special applications or alternate bearings consult factory. See bearing information on page 13
- For customization & special application options, please consult factory

Wheel Diameter (Inches)	Tread Width (Inches)	Capacity (Lbs) (Rated for manual operation)	Hub Length (Inches)	Bore ID (Inches)	Bearing ID (Inches)	Approx. Wt. (Lbs)	Wheel Number Roller Bearing (01)	Wheel Number Plain Bore (00)
Crowned Tread Neoprene on Aluminum (MG)								
4	2	500	2-3/16	1-3/16				MG0420019
4	2	500	2-3/16		1/2		MG0420108	
5	2	600	2-3/16	1-3/16				MG0520019
5	2	600	2-3/16		3/4		MG0520112	
6	2	700	2-3/16	1-3/16				MG0620019
6	2	700	2-3/16		3/4		MG0620112	
8	2	700	2-3/16	1-3/16				MG0820019
8	2	700	2-3/16		3/4		MG0820112	

NP



Premium Quality



Ergonomic



Maintenance Free

Neoprene on Aluminum



The NP wheel has very high resilience, is impervious to metal chips and screws, and has an extremely high chemical resistance. This wheel will perform well in contact with oils and chemicals, and can be used over a wide temperature range. The NP wheel is tough, and is designed to handle heavy loads.

FEATURES

- **Wheel face:** Full Radius
- **Finish:** Blue on aluminum core
- **Temperature Range:** -22°F to +220°F
- **Hardness:** 60-70 Shore A

WHEEL OPTIONS

- Note: Select bearings featured are recommended for standard applications. For special applications or alternate bearings consult factory. See bearing information on page 13
- For customization & special application options, please consult factory

Wheel Diameter (Inches)	Tread Width (Inches)	Capacity (Lbs) (Rated for manual operation)	Hub Length (Inches)	Bore ID (Inches)	Bearing ID (Inches)	Approx. Wt. (Lbs)	Wheel Number Precision Bearing (28)
Round Tread Neoprene on Aluminum (NP)							
5	2	600	2-7/16		1/2		NP0522808
6	2	700	2-7/16		1/2		NP0622808
8	2	700	2-7/16		1/2		NP0822808

OA



Premium Quality

Press-On Rubber Wheels



For capacities and service conditions beyond the capabilities of regular cushion tread wheels, we offer industrial press-on wheels. These are available in either **standard** or **deluxe** Hi-Profile cushion type.

FEATURES

- **Wheel face:** Moderate crown
- **Finish:** Black tread with grey enamel core
- **Temperature Range:** +40°F to +180°F
- **Hardness:** 60–80 Shore A

WHEEL OPTIONS

- Note: Select bearings featured are recommended for standard applications. For special applications or alternate bearings consult factory. See bearing information on page 13
- For custom & special application options, please consult factory

- Regular or Deluxe
- High Capacity
- Mold-On Rubber





Wheel Diameter (Inches)	Tread Width (Inches)	Tire ID, Core OD (Inches)	Capacity (Lbs) (Based on manual operation)	Hub Length (Inches)	Bore ID (Inches)	Bearing ID (Inches)	Approx. Wt. (Lbs)	Wheel Number Roller Bearing (01)	Wheel Number Tapered Roller (09)
Press-On Rubber Wheels (OA)									
8-1/2	4	4	1270	4-1/4	1-15/16	1	23	OA087011601	
8-1/2	4	4	1270	4-1/2	1.98	1	23		OA087091601
10	6	6-1/4	2320	4-1/4	2-7/16	1-1/4	40	OA109012001	
10	6	6-1/4	2320	4-1/2	2-7/16	1-1/4	40		OA109092001
12	4	8	1420	4-1/4	2-7/16	1-1/4	45	OA127012001	
12	4	8	1420	4-1/2	2-7/16	1-1/4	45		OA127092001
12	4-1/2	8	1890	4-1/4	2-7/16	1-1/4	47	OA127012002	
12	4-1/2	8	1890	4-1/2	2-7/16	1-1/4	47		OA127092002
14	4	10	1600	4-1/4	2-7/16	1-1/4	49	OA147012001	
14	4	10	1600	4-1/2	2-7/16	1-1/4	49		OA147092001
15	5	11-1/4	2540	5-1/4	2-7/16	1-1/4	72	OA158012001	
15	5	11-1/4	2540	5-1/2	2-7/16	1-1/4	72		OA158092001
15	6	11-1/4	3150	5-1/4	2-7/16	1-1/2	79	OA159012401	
15	6	11-1/4	3150	5-1/2	2-7/16	1-1/4	79		OA159092001
15	8	11-1/4	4380	8-1/4	2-7/16	1-1/2	135	OA159012402	
15	8	11-1/4	4380	8-1/2	2-9/16	1-1/2	135		OA159092401
15	9	11-1/4	4570	9-1/4	2-7/16	1-1/2	142	OA159012403	
15	9	11-1/4	4570	9-1/2	2-9/16	1-1/2	142		OA159092402
16	4	14	1770	4-1/4	2-7/16	1-1/4	58	OA167012001	
16	4	14	1770	4-1/2	2-7/16	1-1/4	58		OA167092001
16	4-1/2	14	2040	4-1/4	2-7/16	1-1/4	61	OA167012002	
16	4-1/2	14	2040	4-1/2	2-7/16	1-1/4	61		OA167092002
18	5	14	2540	4-1/4	2-7/16	1-1/4	92	OA188012001	
18	5	14	2540	4-1/2	2-7/16	1-1/4	92		OA188092001
18	12	14	9100	12-1/4	2-7/16	1-1/2	200	OA188012401	
18	12	14	9100	12-1/2	2-9/16	1-1/2	200		OA189092401
20	5	16	2750	5-1/4	2-7/16	1-1/2	117	OA208012401	
20	5	16	2750	5-1/2	2-7/16	1-1/4	117		OA208092001
20	6	16	3920	5-1/4	2-7/16	1-1/2	126	OA209012401	
20	6	16	3920	5-1/2	2-9/16	1-1/2	126		OA209092401
20	9	16	5820	9-1/4	2-7/16	1-1/2	229	OA209012402	
20	9	16	5820	9-1/2	2-9/16	1-1/2	229		OA209092402
22	10	16	8260	10-1/4	2-7/16	1-1/2	260	OA229012401	
22	10	16	8260	10-1/2	2-9/16	1-1/2	260		OA229092401
22	12	16	10190	12-1/4	2-7/16	1-1/2	286	OA229012402	
22	12	16	10190	12-1/2	2-9/16	1-1/2	286		OA229092402

Wheel Diameter (Inches)	Tread Width (Inches)	Tire ID, Core OD (Inches)	Capacity (Lbs) (Based on manual operation)	Hub Length (Inches)	Bore ID (Inches)	Bearing ID (Inches)	Approx. Wt. (Lbs)	Wheel Number Roller Bearing (01)	Wheel Number Tapered Roller (09)
Deluxe Press-On Rubber Wheels (OA)									
13	4-1/2	8	2040	4-1/4	2-7/16	1-1/4	49	OA137012001	
13	4-1/2	8	2040	4-1/2	2-7/16	1-1/4	49		OA137092001
14	4-1/2	8	2120	4-1/4	2-7/16	1-1/4	52	OA147012001	
14	4-1/2	8	2120	4-1/2	2-7/16	1-1/4	52		OA147092001
15-1/2	6	10	3400	4-1/4	2-7/16	1-1/2	68	OA159012404	
15-1/2	6	10	3400	4-1/2	2-7/16	1-1/4	68		OA159092002
16-1/4	4	11-1/4	2050	5-1/4	2-7/16	1-1/4	69	OA167012003	
16-1/4	4	11-1/4	2050	5-1/2	2-7/16	1-1/4	69		OA167092003
16-1/4	6	11-1/4	3470	5-1/4	2-7/16	1-1/2	83	OA169012401	
16-1/4	6	11-1/4	3470	5-1/2	2-7/16	1-1/4	83		OA169092001
16-1/4	7	11-1/4	4190	7-1/4	2-7/16	1-1/2	127	OA169012402	
16-1/4	7	11-1/4	4190	7-1/2	2-9/16	1-1/2	127		OA169092401
18	5	12-1/8	2980	4-1/4	2-7/16	1-1/2	72	OA188012401	
18	5	12-1/8	2980	4-1/2	2-7/16	1-1/4	72		OA188092002
18	6	12-1/8	3800	4-1/4	2-7/16	1-1/2	81	OA189012402	
18	6	12-1/8	3800	4-1/2	2-9/16	1-1/4	81		OA189092001
18	8	12-1/8	5450	8-1/4	2-7/16	1-1/2	132	OA189012403	
18	8	12-1/8	5450	8-1/2	2-9/16	1-1/2	132		OA189092402
21	6	15	4270	5-1/4	2-7/16	1-1/2	117	OA219012401	
21	6	15	4270	5-1/2	2-9/16	1-1/2	117		OA219092401
21	8	15	6120	8-1/4	2-7/16	1-1/2	192	OA219012402	
21	8	15	6120	8-1/2	2-9/16	1-1/2	192		OA219092402
22	6	16	4420	5-1/4	2-7/16	1-1/2	135	OA229012403	
22	6	16	4420	5-1/2	2-9/16	1-1/2	135		OA229092403
22	8	16	6340	8-1/4	2-7/16	1-1/2	232	OA229012404	
22	8	16	6340	8-1/2	2-9/16	1-1/2	232		OA229092404



PRESS-ON RUBBER WHEELS • UP TO 10190

CASTER ACCESSORIES

Caster Brakes

 Brakes for Light Duty Casters.....	179
 Brakes for Medium & Heavy Duty Casters.....	179-180
Brakes Kits.....	181

Swivel Locks/Pads/Jacks

 Swivel Locks.....	182
 Quick-Release Caster Pads.....	182
 Leveling Jacks.....	182

Floor Locks

 16 Series ERGO (LE).....	183
 Cast Iron (LF).....	183
 02 Series (LF).....	184
 Standard (LF).....	184
 E-Line.....	185

 Turntables.....	185
---	-----

 Bumpers.....	186
--	-----

 Optional Plates.....	187
--	-----

 Caster and Wheel Replacement Parts.....	188-191
---	---------

Caster Brakes

Brakes for Light Duty Casters

02/04 Face Contact Brake



Available on 02 & 04 Series.

02 Part #	Dia.	04 Part #	Dia.
FB020300	3"	FB040300	3"
FB020350	3.5"	FB040350	3.5"
FB020400	4"	FB040400	4"
FB020500	5"	FB040500	5"

P2 Face Contact Brake



Available on P2 Series.

Part #	Dia.
FBDC0300	3"
FBDC0350	3.5"
FBDC0400	4"
FBDC0500	5"

02 Grip Lock Brake



Available on 02 Series.

Corrosion resistant brake features rugged thermoplastic construction.

Part #	Dia.
GL020300	3"
GL020350	3.5"
GL020400	4"
GL020500	5"

02 Total Lock Brake



Available on 02 Series.
Locks wheel and swivel with simple press of toe lever. Add **T** to end of part number for factory orders.

P2 Total Lock Brake



Available on P2 Series.
Locks wheel and swivel with simple press of toe lever. Add **T** to end of part number for factory orders.

LASER CUT INTEGRATED BRAKES



New PLB brakes are now available for medium to heavy duty casters, consult factory.

LASER CUT INTEGRATED TOE GUARDS



New Integrated toe guards are now available for medium to heavy duty casters, consult factory.

Brakes for Medium and Heavy Duty Casters

12/16 FBA Face Brake



Available on 12 and 16 Series.
Step down to engage and release brake. Will not work with swivel locks.

Part #	Dia.
FB140400	4"
FB140500	5"
FB140600	6"
FB140800	8"

FBB Face Brake



Available on 12, 16, 18, 60, 61, 62, 71, 72, 110, 170, 310, 410 Series.

Part #	Arm Angle	Dia.
WK040202WA	55°	4"
WK050202WA	55°	5"
WK060202WA	55°	6"
WK080202W	75°	8"

FBC Face Brake



Available on 18, 100, 110, and 170 Series.

Part #	Dia.
FB180400	4"
FB180500	5"
FB180600	6"
FB180800	8"

FBD Stainless Steel Face Brake



Available on E5, and 120 Series.
FB12000 includes rubber pad on brake arm.

05 Series		E5, 120 Series	
Part #	Dia.	Part #	Dia.
FB050400	4"	FB120400	4"
FB050500	5"	FB120500	5"
FB050600	6"	FB120600	6"
FB050800	8"	FB120800	8"

Caster Brakes

Brakes for Medium and Heavy Duty Casters (continued)

FBE Face Brake



Available on 12, 16, 18, 60, 61, 62, 71, 110 and 170 Series.
Works on 6" and 8" rigid casters.

Part #	Dia.
FB160400	4"
FB160500	5"
FB160600	6"
FB160800	8"

FBF Stainless Steel Face Brake



Available on E5 Series.
Works on swivel and rigid casters.

Part #	Dia.
WKE50400	4"
WKE50500	5"
WKE50600	6"
WKE50800	8"

FBG Stainless Steel Face Brake



Available on E5, and 120 Series stainless steel. Works on 6" and 8" rigid casters.

Part #	Dia.
WK1200400	4"
WK1200500	5"
WK1200600	6"
WK1200800	8"

Cam Brake



Available on 12, 16, 18, 60, 61, 62, 71, 72, 110 and 170 Series.
Works on swivel or rigid casters.
Can be used with roller, Delrin, and Oilex bearings. May appear different on other series. Please note: Not all brake / bearing combinations will work – please consult factory.

Part #
WK405101 Long pedal
WK405104 Short pedal

CB Stainless Steel Cam Brake



Available on E5 and 05 Series.
Works only on swivel casters.
Can be used with roller, Delrin, and Oilex bearings. May appear different on other series. Please note: Not all brake / bearing combinations will work – please consult factory.

Part #
WK405200 Short pedal
WK405201 Long pedal

Total Lock Brake



Available on 16 Series.
6" rig requires 7-1/2" HS60 option.

Part #	Dia.
TL160400	4"
TL160500	5"
TL160600	6"
TL160800	8"

Grip Lock Brake



Available on 16 Series.
Does not work with swivel lock.

Part #	Dia.
GL160400	4"
GL160500	5"
GL160600	6"
GL160800	8"

Integrated Poly Lock Brake



Available on 90, 110, 310, 410, 600, 610 and 700 Series.
New laser cut design. Large poly brake pedal engages metal plate against wheel tread for positive braking. Brake can mount trailing or leading position (leading shown).

Poly Cam Brake



Available on all swivel and rigid casters, except stainless steel and spring loaded.
Add **P** to end of the part number for factory orders.

Single Side Brake



Available on all swivel and rigid casters, except stainless.
Right hand installation standard, left hand option available. Add **SSB** to end of part number for factory orders.

Double Side Brake



Available on all swivel and rigid casters, except stainless. Same as Single Side Brake, except brake on both sides. Add **DSB** to end of part number for factory orders.

Face Contact Brake



Available on all swivel and rigid casters, except stainless and spring loaded. Turn lever to apply shoe against wheel tread for positive locking action. Add **F** to end of part number for factory orders.

Caster Brakes

Brakes Kits for Light Duty to Medium Heavy Duty Casters

Kit Number	Series	For Wheel Size	Brake Type	Exceptions
FBDC0300 FBDC0350 FBDC0400 FBDC0500	DC, P2	3" 3.5" 4" 5"	Face contact, pedal on side	
FB020300 FB020350 FB020400 FB020500	02	3" 3.5" 4" 5"	Face contact, pedal on side	
GL020300 GL020350 GL020400 GL020500	02	3" 3.5" 4" 5"	Face contact, pedal trailing	
FB040300 FB040350 FB040400 FB040500	04	3" 3.5" 4" 5"	Face contact, pedal on side	
WK405101 WK405104	12, 16, 61, 62 71, 72, 100, 110	6", 8" 4", 5"	Cam action brake, side pedal	Not for precision or Delrin bearings
WK405200 WK405201	05	4", 5" 6", 8"	Cam action brake, side pedal	Not for precision or Delrin bearings
FB140400 FB140500 FB140600 FB140800	12, 16	4" 5" 6" 8"	Face contact, pedal on side	
FB180400 FB180500 FB180600 FB180800	18, 110	4" 5" 6" 8"	Face contact, pedal on side	
GL160400 GL160500 GL160600 GL160800	12, 16	4" 5" 6" 8"	Face contact, pedal trailing	
ZL04208 ZL05208 ZL06208 ZL08208	12, 16, 18, 61, 62, 71, 72, 78, 100, 110	4" 5" 6" 8"	Face contact, pedal trailing	For use on wheels with 2.438" hub length only.
ZL05408 ZL06408 ZL08408	61, 62, 63, 72, 78	5" 6" 8"	Face contact, pedal trailing	For use on wheels with 2.75" hub length only.

Swivel Locks



Welded Hand Operated



Field Installable
Hand Operated



Field Installable
Foot Operated

Hand activated or foot activated plunger can be disengaged for continuous swiveling or engaged for straight line traveling. Requires notched yoke base. **To order standard swivel lock installed add "L" to end of caster number.** For field installation options see chart.

Series	Factory Install Code	Hand Operated Field Installable Part Numbers	Foot Operated Field Installable Part Numbers
05 to 90 Series Swivel Locks			
16	L	SL160000	SL160002
18*	L	SL160000	SL1000005
40	L	SL160000	N/A
42	L	SL810000	N/A
44	L	SL90000002	N/A
61	L	SL610000	N/A
62	L	SL620000	N/A
63	L	SL620000	N/A
71*	L	SL160000~	SL160002~
72	L	SL720000	N/A
78	L	SL720000	N/A
81*	L	SL810000~	N/A
84	L	SL810000	N/A
90	L	SL900000	N/A
92	L	SL920000	N/A

Series	Factory Install Code	Hand Operated Field Installable Part Numbers	Foot Operated Field Installable Part Numbers
92 to 850 Series Swivel Locks			
94	L	SL940000	N/A
95	L	SL954600	N/A
100*	L	SL160000	SL160002
110*^	L	SL160000	SL160002
120*	L	SL1200000	N/A
300*	L	SL3000000	N/A
310*	L	SL3000000	N/A
330*	L	SL3000000	N/A
400*	L	SL4000000	N/A
410*	L	SL4000000	N/A
600*	L	SL6000000~	N/A
610*	L	SL6000000~	N/A
700*	L	SL7000000~	N/A
850*	L	SL8500000~	N/A

^ SL16000006 if you specify K plate.

* Swivel lock is not attached to caster.
~ Requires notched yoke.

Quick-Release Caster Pads



Albion quick-release caster pads make changing casters fast and easy.

- Simplifies caster replacement
- Install or replace casters with just one nut & bolt
- Unplated for easy welding to carts

Description	Series	Caster Pad Number
Quick Release Caster Pads		
Fits 2-1/2" x 3-5/8" Top Plate	02, P2	PC020000
Fits 4" x 4-1/2" Top Plate	16	PC160000
Fits 4" x 4-1/2" Top Plate	18, 110	PC110000
Fits 4-1/2" x 6-1/4" Top Plate	62, 63, 72, 16 Pattern K, 310	PC620000



Leveling Jacks



- Retractable Folding Hand Crank
- Reinforced rubber pad on base
- Zinc plated for corrosion resistance
- For leveling, stabilizing and elevating portable equipment

Overall Height	Min. Ht. Below Frame of Equipment	Max. Extended Ht. Below Frame of Equipment	Length of Screw Travel	Approx. Weight (lbs)	Part Number
Leveling Jacks					
18"	4-1/2"	13-1/2"	9"	10-1/2	J625
26"	4-1/2"	21-1/2"	17"	12-1/2	J622
30"	4-1/2"	25-1/2"	21"	14	J627

LE 16 Series ERGOnomic Floor Locks

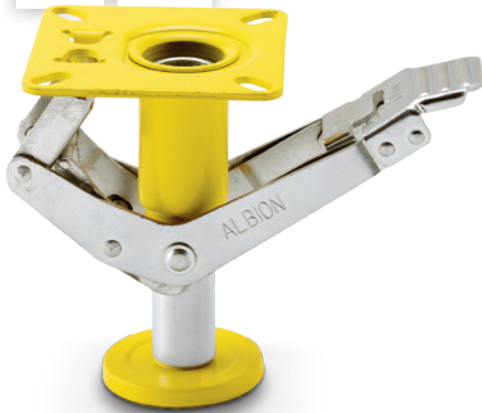

Caster Wheel Diameter (Inches)	Caster Series Number	Caster Height (Inches)	Retracted Clearance (Inches)	Approx. Wt. (Lbs)	Floor Lock Number
LE ERGOnomic Floor Locks					
6	16	7-1/4	1-1/2	3-3/4	16LE0680
8	16	9-1/2	1-1/2	3-3/4	16LE0880
6	110	7-1/2	1-1/2	3-3/4	110LE0680
8	110	10-1/8	1-1/2	3-3/4	110LE0880



Easy to engage. Simply push down on ergonomically designed extended pedal to activate.



Easy to disengage. Simply push down on top pedal to deactivate.

FEATURES

- Ergonomically designed extended pedals make this floor lock the best in the industry!
- Bright Safety Yellow powder coating
- Easy to operate – even with steel toed boots
- Top plate bolt hole spacing: same as 16 Series
- Brake Shoe: Large, non-skid, molded rubber for solid, no-slip contact
- Foot Pedal: Adjusted by slight foot pressure for simple, instant locking
- Finish: Corrosion resistant zinc plate and powder coating for long-use

LF Cast Iron Floor Locks

This floor lock allows you to immobilize equipment in any desired location, but does not interfere with its movement when not in use. Platform trucks, fixture dollies or other castered items can be locked in place by a simple press of the foot. Locking action is created when a large, round friction face of nearly 10 sq. inches in area is pressed against the floor with the force of 70 to 100 lbs. This position lock does not lift equipment.



Caster Wheel Diameter (Inches)	Extended Working Height (Inches)	Retracted Height (Inches)	Mounting Plate Size (Inches)	Bolt Hole Spacing (Inches)	Attaching Bolt Size (Inches)	Approx. Wt. (Lbs)	Floor Lock Number
LF Cast Iron Floor Locks							
4	5-5/8	5	3-11/16 x 5-3/8	2-5/8 x 3-5/8	3/8	7-3/4	920LF04548
5	6-1/2	5-7/8	3-11/16 x 5-3/8	2-5/8 x 3-5/8	3/8	8	930LF05650
5	7-9/32	6-21/32	3-11/16 x 5-3/8	2-5/8 x 3-5/8	3/8	8-1/4	930LF05728
5	7-5/8	6-1/2	4-1/2 x 6	2-7/16 x 4-15/16	1/2	10-1/4	930LF05762
6	7-3/8	6-3/4	3-11/16 x 5-3/8	2-5/8 x 3-5/8	3/8	8-1/4	940LF06737
6	7-1/2	6-7/8	3-11/16 x 5-3/8	2-5/8 x 3-5/8	3/8	8-1/4	940LF06750
6	7-1/2	6-3/8	4-1/2 x 6	2-7/16 x 4-15/16	1/2	10-1/2	940LF06751
6	7-25/32	6-21/32	4-1/2 x 6	2-7/16 x 4-15/16	1/2	10-1/2	940LF06778
6	8-1/8	7	4-1/2 x 6	2-7/16 x 4-15/16	1/2	10-1/2	940LF06812
8	9-1/2	8-3/8	4-1/2 x 6	2-7/16 x 4-15/16	1/2	10-1/2	950LF08950
8	9-1/2	8-7/8	3-11/16 x 5-3/8	2-5/8 x 3-5/8	3/8	9-1/2	950LF08951
8	9-7/8	8-3/4	4-1/2 x 6	2-7/16 x 4-15/16	1/2	10-1/2	950LF08987
8	10-5/16	9-3/16	5-3/8 x 7-1/4	3-3/8 x 5-1/4	1/2	15	950LF081031
8	10-1/2	9-5/8	5-3/8 x 7-1/4	3-3/8 x 5-1/4	1/2	15-1/4	950LF081050
10	11-1/2	10-3/8	4-1/2 x 6	2-7/16 x 4-15/16	1/2	11-1/2	980LF101150
10	12-1/2	11-3/8	5-3/8 x 7-1/4	3-3/8 x 5-1/4	1/2	15-1/4	980LF101250

FEATURES

- **Brake Shoe:** Large, non-skid, molded rubber for solid, no-slip contact
- **Foot Pedal:** Adjusted by slight foot pressure for simple, instant locking
- **Finish:** Painted

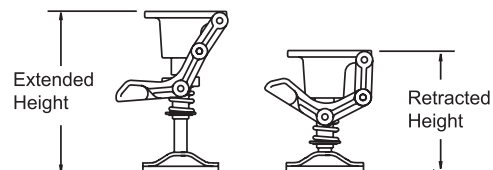

LF

02 Series Floor Locks



The Albion 02 Series floor locks are designed to hold your portable equipment in a desired location. Intended for use on level surfaces, the floor lock is activated by toe pressure on the extension pedal or released by toe touching one of the dual retractable plates. For best results, units should be used in pairs.

Caster Wheel Diameter (Inches)	Caster Series Number	Caster Height (Inches)	Retracted Clearance (Inches)	Approx. Wt. (Lbs.)	Floor Lock Number
3-1/2	02	4-11/16	3/4	2-3/4	02LF03X80
4	02	5-1/8	3/4	2-3/4	02LF0480
5	02	6-3/16	3/4	2-3/4	02LF0580

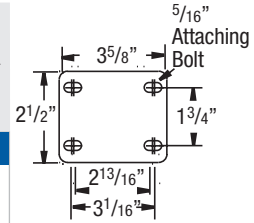

FEATURES

- **Top Plate:** dimension matches standard 02 Series caster top plate for easy installation
- **Brake Shoe:** Large, non-skid, molded rubber for solid, no-slip contact
- **Foot Pedal:** Adjusted by slight foot pressure for simple, instant locking
- **Finish:** Corrosion resistant zinc plating for long-use



Floor Lock Engaged



Floor Lock Disengaged

LF

Standard Floor Locks



Designed to hold portable equipment in a desired location. Intended for use on level surfaces. Floor lock is activated by toe pressure on the extension pedal or released by toe touching one of the dual retractable plates. The large non-skid brake pad, under high spring compression, holds the portable piece of equipment until released. For best results, units should be used in pairs.

Caster Wheel Diameter (Inches)	Caster Series Number	Caster Height (Inches)	Retracted Clearance	Approx. Wt. (Lbs.)	Floor Lock Number
--------------------------------	----------------------	------------------------	---------------------	--------------------	-------------------

16/71 Series Floor Locks					
4	16, 71	5-5/8	3/4	3-1/4	16LF0480
5	16, 71	6-1/2	3/4	3-1/2	16LF0580
6	16	7-1/4	3/4	3-1/2	16LF0680
6	71	7-1/2	3/4	3-3/4	71LF0680
8	16	9-1/2	3/4	4	16LF0880
8	71	10-1/8	3/4	4-1/2	71LF0880

05 Stainless Steel Series Floor Locks					
4	05	5-5/8	3/4	3-1/4	05LF0480
5	05	6-1/2	3/4	3-1/2	05LF0580
6	05	7-1/2	3/4	3-3/4	05LF0680
8	05	9-1/2	3/4	4	05LF0880

12/61 Series Floor Locks					
4	12, 61	5-5/8	9/16	4	12LF0480
5	12, 61	6-1/2	1	4-1/4	12LF0580
6	12, 61	7-3/8	1	4-1/4	12LF0680
8	12, 61	9-1/2	1	4-3/4	12LF0880

62, 63, 72, 81 Series Floor Locks					
4	62, 63, 72, 81	5-5/8	9/16	4	62LF0480
5	62, 63, 72, 81	6-1/2	1	4-1/4	62LF0580
6	62, 63, 72, 81	7-1/2	1	4-1/4	62LF0680
8	62, 63, 72, 81	10-1/8	1	4-1/2	62LF0880

90 Series Floor Locks					
6	90	8	1	6	90LF0680
8	90	10-1/2	1	6-1/2	90LF0880

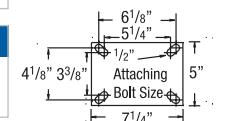
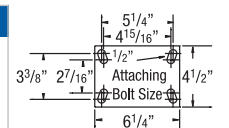
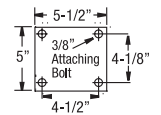
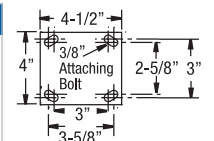
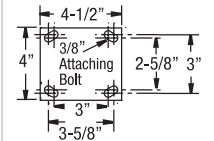

FEATURES

- **Top Plate:** Steel matching regular caster tops for easy installation
- **Brake Shoe:** Large, non-skid, molded rubber for solid, no-slip contact
- **Foot Pedal:** Adjusted by slight foot pressure for simple, instant locking
- **Finish:** Corrosion resistant zinc plating for long-use

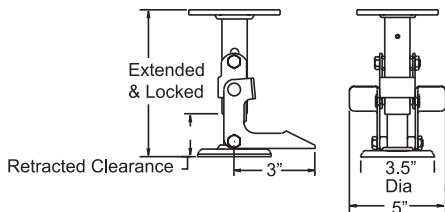

E-Line Floor Locks

Standard Floor Locks



Caster Wheel Diameter (Inches)	Caster Series Number	Caster Height (Inches)	Retracted Clearance	Approx. Wt. (Lbs.)	Floor Lock Number
E-Line Series Floor Locks					
4"	E-Line	5-5/8"	3/4"	3-1/4	FL-4E
5"	E-Line	6-1/2"	3/4"	3-1/2	FL-5E
6"	E-Line	7-1/2"	3/4"	3-3/4	FL-6E
8"	E-Line	9-1/2"	3/4"	4	FL-8E

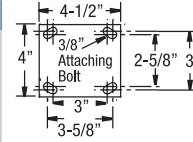

Double Pedal Floor Locks



Caster Wheel Diameter (Inches)	Caster Series Number	Caster Height (Inches)	Retracted Clearance	Approx. Wt. (Lbs.)	Floor Lock Number
E-Line Series Floor Locks					
4"	E-Line	5-5/8"	1"	3-7/8	FLOCKE40
5"	E-Line	6-1/2"	1"	4	FLOCKE50
6"	E-Line	7-1/2"	1-3/8"	4-1/2	FLOCKE60
8"	E-Line	9-1/2"	1-1/4"	4-3/4	FLOCKE80

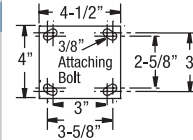

FEATURES

- **Top Plate:** dimension matches standard E-Line and 16 Series caster top plate for easy installation
- **Brake Shoe:** Large, non-skid, molded rubber for solid, no-slip contact
- **Foot Pedal:** Adjusted by slight foot pressure for simple, instant locking
- **Finish:** Corrosion resistant zinc plating for long-use

Adaptable to all types of portable equipment, the double pedal floor lock allows for easier floor lock engagement.

Shockmaster and Contender Turntables



Turntable Description	Top Plate Size (Inches)	Overall Height (Inches)	Capacity (Lbs.)	Part Number
Shockmaster Turntables				
1/2" thick mounting plates, 3/4" ball bearings (4-1/2" raceway)	6-1/4" X 7-1/4"	2.75"	10000	TT600000
1/2" thick mounting plates, 3/4" ball bearings (7" raceway)	8-1/2" X 8-1/2"	3.125"	20000	TT700000
Contender Turntables				
1/4" thick mounting plates, 3/8" ball bearings	4" X 4-1/2"	1.53"	1400	TT110000
5/16" mounting plates, 1/2" ball bearings	4-1/2" X 6-1/4"	1.75"	4100	TT310000
3/8" thick mounting plates, 1/2" ball bearings	5-1/4" X 7-1/4"	1.75"	5400	TT410000
1/2" thick mounting plates, 3/4" ball bearings (4-1/2" raceway)	6-1/4" X 7-1/4"	2.78"	9500	TT610000

APPLICATIONS

- Manufacturing
- Packaging
- Assembly
- Repairs
- Material Handling
- Displays
- Painting
- More ...

BP Protection Bumpers

Protect your equipment, walls and other structures 24 hours a day ... 7 days a week.

FEATURES

- Protects mobile equipment, stationary equipment, cargo and other structures from damage due to impacts
- Resistant to skidding, staining and marking
- Crack resistant & resilient
- Vibration & shock dampening
- Custom colors available

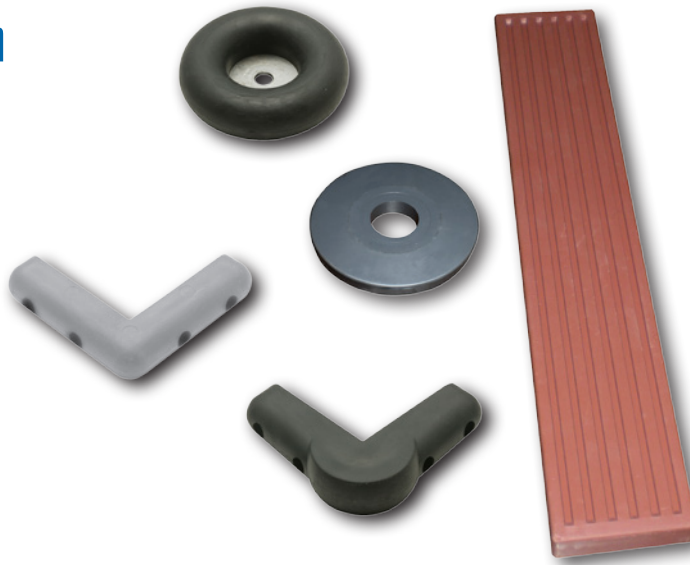

End (Round) Bumpers
Generally used on the ends of tubular handles. Protects equipment, walls, door facings and other structures.

Specifications	Bumper Number
End (Round) Bumpers	
Black 3-1/4" dia. x 7/8" thick. Center mounting bolt size 5/16"	BP30521201
Grey 3-1/4" dia. x 7/8" thick. Center mounting bolt size 5/16"	BP30521202

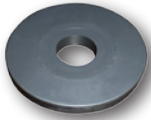

End (Round) Bumpers
Economical model with no metal inserts.

Specifications	Bumper Number
Economical End (Round) Bumpers	
3-1/2" diameter x 5/8" thick. Center diameter 1"	BP16551001

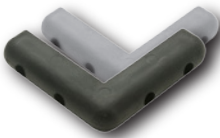

Corner Bumpers
Protects wide variety of mobile equipment from bumps and scrapes. Steel inserts included for greater durability. Ends of bumpers can be cut at notched area to make square ends.

Specifications	Bumper Number
Corner Bumpers	
Black 7/8" thick x 1" high x 3-1/2" long from inside corner to sides; Holes for #10 screws.	BP08646401
Grey 7/8" thick x 1" high x 3-1/2" long from inside corner to sides; Holes for #10 screws.	BP08646402



Reinforced Corner Bumpers
Similar to corner bumpers above but with extra material in main corner impact area

Specifications	Bumper Number
Reinforced Corner Bumpers	
Black 1" thick x 1-1/16" high x 3-1/16" long from inside corner to sides	BP08707001
Grey 1" thick x 1-1/16" high x 3-1/16" long from inside corner to side	BP08707002



End Cap Bumper Pad
Excellent protection for wood dollies. Easy slip-on installation.

Specifications	Bumper Number
End Cap Bumper Pad	
Inside dimension 18" x 3" (Reddish Brown)	BP040410001

Optional Features

We carry top plates with optional dimensions and bolt hole patterns. As shown in the chart, these will interchange with standard top plates. For an optional top plate not listed, please consult factory. To order, begin with ST (swivel) or RT (Rigid) followed by the caster series number (i.e. 16), then end with the alpha designation (i.e. J).

Example: 16TM06201S
 ST16J
 Swivel top (ST), 16 series (16), bolt hole center (J)

Example: 272PD06201R
 RT272D
 Rigid top (RT), dual wheel (2), 72 series (72), bolt hole center (D)

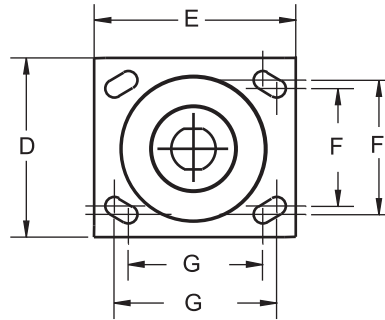

Top Plate and Bolt Hole Center Chart

F & G Bolt Hole Centers (Inches)	D & E Top Plate Size (Inches)	Attaching Bolt (Inches)	Series 12, 16	Series 71	Series 72	Series 81	Series 94	Series 95	Series 18, 100, 110	Series 310, 410	Series 400
Slotted for 3 x 4 to 2-5/8 x 3-5/8	4 x 5	3/8	J	J							
Slotted for 3-3/8 x 5-1/4 to 2-7/16 x 4-15/16	4-1/2 x 6-1/4	1/2	K						K		
2-1/8 x 4	4 x 5	3/8		G							
3 x 3	4 x 4	3/8		H							
3-1/4 x 6	4-1/2 x 7-1/4	1/2			W	W					
4-1/8 x 4-1/2	5 x 5-1/2	3/8	D		D	D			D (110 only)		
4-7/8 x 6-3/4	Swivel 6-1/2 x 8 Rigid 6 x 8	5/8					C				
7 x 9-3/4	8-1/2 x 11	5/8						T			
Slotted for 4-5/8 x 5-1/2 to 4-3/8 x 5-5/8	6 x 7	1/2								S	N

Optional Overall Heights

Series	Wheel Diameter (Inches)	Optional Height (Inches)	Swivel Lead (Inches)	Swivel Option Number	Rigid Option Number
12, 16, 33	3-1/4	5-1/4	1-11/16	HS42	HR42
12, 16, 33	4	5-1/4	1-11/16	HS86	HR86
12, 16, 33	5	6-1/8	1-11/16	HS-50	HR50
12, 16, 33	5	6-3/4	1-3/4	HS54	HR54
12, 16, 33	6	6-7/8	2-1/2	HS56	HR56
12	6	7-1/4	1-3/4	HS82	HR82
16	6	7-3/8	1-3/4	HS59	HR59
16	6	7-1/2	1-7/8	HS60	HR60
62	6	7-3/4	1-3/4	HS85	HR85
12, 16	8	10	1-3/4	HS81	HR81
34, 62	8	9-1/2	2-1/4	HS76	HR76
34, 62	8	9-3/4	1-3/4	HS83	HR83
63	8	9-1/2	2-1/4	HS84	HR84
100	8	9-1/2	2-1/2	HS89	HR89

Replacement Parts

Axle and Bearing Components for Standard Models (Consult factory for parts not in this chart)

Caster Series	Wheel Hub Length (Inches)	Axle Hollow	Axle Solid	NUT	Spanner Bushing	Lock Washer	Roller Bearing	Plain Retaining Washer	Sealed Retaining Washer	Nylon sealed combowasher	Metal combowasher	Thrust Washer
DC, P2, 02 Series	1.25"	ZJ063502, ZJ063504		NL061600	ZF060824, ZF060826		ZB081718	WA081703				WA082400, WA082406
04 Series	1.25"	ZJ063510		NJ061600	ZF06082401							
05 Series	2.188"	ZJ085600	ZJ085603	NJ081311	ZF081240	WA081401	ZB12193001	WA121904	WA121990	WA121905		WA122603
12,16,18,40, 61,62,71,72, 110	2.188"	ZJ085400	ZJ085403	NL082000	ZF081239		ZB121930	WA121900	WA121990	WA121905	WA121999	WA122600
42,61,62,72, 78 Series	2.75"	ZJ086400	ZJ086403	NL082000	ZF081248		ZB121940	WA121900	WA121990	WA121905	WA121999	WA122600
63 Series	2.75"	ZJ126800		NL121001	ZF121648		ZB163140	WA163103	WA163190		WA163199	WA163900
44,81,84,90, 92,310, 410	3.25"	ZJ127600		NL121001	ZF121657, ZF162057		ZB163148, ZB203948	WA163103, WA203103	WA163190, WA203190		WA163199,	WA163900, WA204800
330 Series	3.25"	ZJ12760009	ZJ128010	NJ121000	ZF12165703	WA122006	ZB16314803	WA16310304	WA16319001		WA163199	WA16390001
600 Series	3.25"		ZJ161496	NL161403	ZF162057		ZB203148, ZB203948	WA203103, WA203903	WA203190, WA203950		WA163199,	WA163900, WA204800
90,92, 600 Series	4.25"	ZJ169601	ZJ161496	NL161403	ZF162073		ZB203964	WA203903	WA203990			WA204800

Axle and Bearing Components for Standard Models (Consult factory for parts not in this chart) (Continued)

Caster Series	Wheel Hub Length (Inches)	Precision Ball Bearing	Delrin Bearing (2 pieces)	Delrin Bearing (1 piece)	Bronze Bearing	Oillex Bearing	Drawn Cup Roller Bearing	Top Hat Spacer
DC, P2, 02 Series	1.25"							
04 Series	1.25"							
05 Series	2.188"		TF121912	TF121934	0I121908	Z0121935		
12,16,18,40, 61,62,71,72, 78,110	2.188"	ZA081903, ZA081904	TF121912	TF121934	0I121908	Z0121935	ZX121930	ZY0812001
42,61,62,72, 78 Series	2.75"		TF121912		0I121908			



Roller Bearing ZB121930 Shown



Spanner Bushing ZF081239 Shown



Metal Step Retaining Thrust Washer



Nylon Sealed Retaining Thrust Washer WA121905 Shown



Sealed Retaining Thrust Washer



Solid Axle & Nut ZJ085409 Shown



Hollow Axle & Nut ZJ085408 Shown

Replacement Parts



Tapered Roller Bearing

Tapered Roller Bearings and Spacers

Kit Number	Cup Only Part Number*	Cone Only Part Number*	Bearing ID (Inches)	Bearing OD (Inches)	Notes	Spacer Number	Spacer ID (Inches)	Spacer OD (Inches)	Spacer Length (Inches)
ZT082200	ZT082201	ZT082202	0.500	1.375		ZM082800	0.500	1.750	0.000
ZT122800	ZT122801	ZT122802	0.750	1.780		ZY121600	0.750	1.000	0.231
ZT123100	ZT123101	ZT123102	0.750	1.938		ZY121600	0.750	1.000	0.231
ZT163200	ZT163202	ZT163101	1.000	1.979		ZY162004	1.000	1.250	0.281
ZT163900	ZT163901	ZT163902	1.000	2.438		ZY162005	1.000	1.250	0.313
ZT203900	ZT163901	ZT203911	1.250	2.438	Wider	ZY202406	1.250	1.500	0.348
ZT203920	ZT203901	ZT203902	1.250	2.438	Narrower	ZY202404	1.250	1.500	0.281
ZT203940	ZT203901	ZT203802	1.250	2.438	Sealed	SD203013	1.250	1.875	0.000
ZT205000	ZT205001	ZT205002	1.250	3.125		ZY202606	1.250	1.625	0.375
ZT244100	ZT244102	ZT244101	1.500	2.563		ZY242806	1.500	1.750	0.375
ZT245000	ZT205001	ZT245001	1.500	3.125		ZY242806	1.500	1.750	0.375

* Purchased as kit only.



Industrial Ball



Pedestal Precision Ball



Precision Ball



Delrin



Bronze



Oil-impregnated Bearing
(Oil impregnated iron)

Other Bearing Types

Bearing Part Number	Description of Bearing	Bearing ID (Inches)	Bearing OD (Inches)	Bearing Length (Inches)	Notes/Suggestions	Requires Part Number
ZA081900	Industrial Ball	0.500	1.188	1.875		
ZA081902	Industrial Ball	0.500	1.188	2.438	Butt Bearing	
ZA081903	Pedestal Precision Ball	0.500	1.188	2.438	Pedestal Bearing	
57703.11	Pedestal Precision Ball	0.500	1.188	1.249	Pedestal Bearing	
57703.14	Stainless Steel Pedestal Precision Ball	0.500	1.188	1.249	Stainless Steel Pedestal Bearing	
ZA081904	Precision Ball	0.500	1.188	2.438	Pedestal Bearing	
ZA122500	Precision Ball	20mm	40mm	Any	6203-2RS	ZY0812001
TF121912	Delrin	0.750	1.188	Any	Not with Cam Brake	
TF121934	Delrin	0.750	1.188	2.438		WA122600 or WA122603
0I121912	Bronze	0.750	1.188	Any		
ZO081722	Oil impregnated iron	0.500	1.063	1.250		
ZO081926	Oil impregnated iron	0.500	1.188	1.875		
ZO081935	Oil impregnated iron	0.500	1.188	2.438		
ZO101926	Oil impregnated iron	0.625	1.188	1.875		
ZO101935	Oil impregnated iron	0.625	1.188	2.438		
ZO121926	Oil impregnated iron	0.750	1.188	1.875		
ZO121935	Oil impregnated iron	0.750	1.188	2.438		

Replacement Parts

Straight Roller Bearing and Retaining Washers

REPLACEMENT PARTS



Roller Bearing



Nylon Sealed Retaining Thrust Washer



Powdered Iron Step Retaining Thrust Washer

Line drawing (below) section view shows typical wheel hub construction with sealed straight and tapered roller bearings. Note spacer tubes are used with tapered roller bearings which increases hub length 1/4" and facilitates proper loading of cup to cone. For non-sealed construction, seal is replaced with retainer and flinger washers.

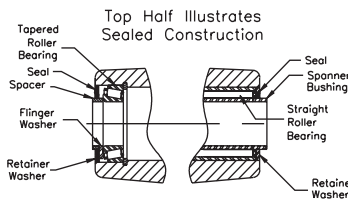

Part Number	Roller Bearing ID (Inches)	Roller Bearing OD (Inches)	Roller Bearing Length (Inches)	Plain Retaining Washer Number	Rubber Sealed Retaining Washer	Nylon Combo Washer Number	Sintered Iron Combo Washer Number	Washer ID (inches)	Washer OD (inches)
ZB081718	0.500	1.063	1.125	WA081703	WA081790			0.500	1.063
ZB081922	0.500	1.188	1.375	WA121900				0.500	1.188
ZB081930	0.500	1.188	1.875	WA121900				0.500	1.188
ZB081932	0.500	1.188	2.000	WA121900				0.500	1.188
ZB101922	0.625	1.188	1.375	WA121900	WA101990			0.625	1.188
ZB101930	0.625	1.188	1.875	WA121900	WA101990			0.625	1.188
ZB101932	0.625	1.188	2.000	WA121900	WA101990			0.625	1.188
ZB101940	0.625	1.188	2.500	WA121900	WA101990			0.625	1.188
ZB121920	0.750	1.188	1.250	WA121900	WA121990	WA121905	WA121999	0.750	1.188
ZB121930	0.750	1.188	1.875	WA121900	WA121990	WA121905	WA121999	0.750	1.188
ZB12193001*	0.750	1.188	1.875	WA121904		WA121905		0.750	1.188
ZX121930	0.750	1.188	1.875	WA121900	WA121990	WA121905	WA121999	0.750	1.188
ZB121940	0.750	1.188	2.438	WA121900	WA121990	WA121905	WA121999	0.750	1.188
ZB142332	0.875	1.438	2.000	WA162303	WA142390			0.875	1.438
ZB162328	1.000	1.438	1.750	WA162303	WA162390			1.000	1.438
ZB162332	1.000	1.438	2.000	WA162303	WA162390			1.000	1.438
ZB163136	1.000	1.938	2.250	WA163103	WA163190		WA163199	1.000	1.938
ZB163140	1.000	1.938	2.500	WA163103	WA163190		WA163199	1.000	1.938
ZB163148	1.000	1.938	3.000	WA163103	WA163190		WA163199	1.000	1.938
ZB163164	1.000	1.938	4.000	WA163103	WA163190		WA163199	1.000	1.938
ZB183148	1.125	1.938	3.000	WA203103			WA203199	1.250	1.938
ZB203140	1.250	1.938	2.500	WA203103	WA203190		WA203199	1.250	1.938
ZB203148	1.250	1.938	3.000	WA203103	WA203190		WA203199	1.250	1.938
ZB203164	1.250	1.938	4.000	WA203103	WA203190		WA203199	1.250	1.938
ZB203948	1.250	2.438	3.000	WA203903	WA203990			1.250	2.438
ZB203964	1.250	2.438	4.000	WA203903	WA203990			1.250	2.438
ZB203980	1.250	2.438	5.000	WA203903	WA203990			1.250	2.438
ZB243948	1.500	2.438	3.000	WA243903	WA243990			1.500	2.438
ZB243964	1.500	2.438	4.000	WA243903	WA243990			1.500	2.438
ZB243980	1.500	2.438	5.000	WA243903	WA243990			1.500	2.438
ZB284964	1.625	3.063	4.000	WA284903				1.750	3.063
ZB284980	1.625	3.063	5.000	WA284903				1.750	3.063
ZB325264	2.000	3.250	4.000	WA325203				2.000	3.250
ZB325280	2.000	3.250	5.000	WA325203				2.000	3.250

* Stainless Steel

Note: Straight roller bearings include roller assembly with split outer race but does not include the retaining washers. Retaining washers are ordered separately in quantities of 2 per wheel.

Axles and Nuts



Solid Axle & Nut
ZJ085409
Shown



Hollow Axle & Nut
ZJ085408
Shown

Axle Part Number	Type	Matching Nut	Matching Lock Washer	Diameter (Inches)	Length (Inches)	Threads (Per Inch)	Notes
ZJ063502	Hollow	NL061600		0.375	2.188	16	No Grease Zerk
ZJ063504	Hollow	NL061600		0.375	2.188	16	
ZJ083510	Solid	NJ061600		0.375	2.188	16	Stainless Steel
ZJ084500	Hollow	NL082000		0.500	2.813	20	
ZJ085400	Hollow	NL082000		0.500	3.375	20	
ZJ085403	Solid	NL082000		0.500	3.375	20	
ZJ085600	Hollow	NJ081311	WA081401	0.500	3.500	13	Stainless Steel
ZJ085603	Solid	NJ081311	WA081401	0.500	3.500	13	Stainless Steel
ZJ086400	Hollow	NL082000		0.500	4.000	20	
ZJ086403	Solid	NL082000		0.500	4.000	20	
ZJ087200	Solid	NL082000		0.500	4.500	20	
ZJ105610	Hollow	NL101800		0.625	3.500	18	
ZJ126802	Hollow	NL121001		0.750	4.250	12	
ZJ127600	Hollow	NL121001		0.750	4.750	12	
ZJ127603	Solid	NL121001		0.750	4.750	12	
ZJ168000	Solid	NL161403		1.000	5.000	14	
ZJ169601	Hollow	NL161403		1.000	6.000	14	
ZJ169602	Solid	NL161403		1.000	6.000	14	

Hollow axles have zerk fitting for lubrication and solid axles are without lubrication fitting. All axles come complete with lock nut. Consult factory for optional slotted nuts and lock pins.

Replacement Parts

Spanner Bushings & Thrust Washers



Spanner Bushing



Nylon Sealed Retaining Thrust Washer



Powdered Iron Step Retaining Thrust Washer

Part Number	Spanner Bushing ID (Inches)	Spanner Bushing OD (Inches)	Spanner Bushing Length (Inches)	Spanner Material	Lubrication Holes	Matching Thrust Washers	Washer I.D. (Inches)	Washer O.D. (Inches)	
ZF060824	0.375	0.500	1.500	Stainless	1	WA082406	0.500	1.500	
ZF06082401	0.375	0.500	1.500		1	WA082400	0.500	1.500	
ZF060826	0.375	0.500	1.625		1	WA102400	0.625	1.500	
ZF081030	0.500	0.625	1.875		2	WA102400	0.625	1.500	
ZF081033	0.500	0.625	2.063		2	WA102400	0.625	1.500	
ZF081036	0.500	0.625	2.250		2	WA102400	0.625	1.500	
ZF081038	0.500	0.625	2.375		2	WA102400	0.625	1.500	
ZF081039	0.500	0.625	2.438		2	WA102400	0.625	1.500	
ZF081046	0.500	0.625	2.875		2	WA102400	0.625	1.500	
ZF081230	0.500	0.750	1.875		2	WA122600	0.750	1.625	
ZF081236	0.500	0.750	2.250		2	WA122600	0.750	1.625	
ZF081238	0.500	0.750	2.375		2	WA122600	0.750	1.625	
ZF081239	0.500	0.750	2.438		2	WA122600	0.750	1.625	
ZF081240	0.500	0.750	2.438		Stainless	2	WA122603	0.750	1.625
ZF081248	0.500	0.750	3.000			2	WA122600	0.750	1.625
ZF081264	0.500	0.750	4.000			none	WA122600	0.750	1.625
ZF101239	0.625	0.750	2.438			2	WA122600	0.750	1.625
ZF121648	0.750	1.000	3.000	2		WA163900	1.000	2.438	
ZF121657	0.750	1.000	3.500	2		WA163900	1.000	2.438	
ZF121664	0.750	1.000	4.000	none		WA163900	1.000	2.438	
ZF121677	0.750	1.000	4.812	none		WA163900	1.000	2.438	
ZF162057	1.000	1.250	3.563	none		WA203903	1.250	2.438	
ZF162073	1.000	1.250	4.563	none		WA204800	1.250	3.000	
ZF162089	1.000	1.250	5.563	none		WA204800	1.250	3.000	
ZF202458	1.250	1.500	3.563	none		WA245600	1.500	3.500	
ZF202473	1.250	1.500	4.563	none		WA245600	1.500	3.500	
ZF202489	1.250	1.500	5.563	none	WA245600	1.500	3.500		

All spanner bushings are hardened to form precision inner race for roller bearings. Except as noted by "none", all spanner bushings are cross drilled for lubrication through hollow axle. Thrust washers are hardened. They are not part of the spanner bushing assembly and must be ordered separately. Thrust washers are not required with ball bearings, 2 piece Delrin bearings, or with combo washers.

ALBION[®]

the caster experts



/// www.AlbionCasters.com

800.835.8911

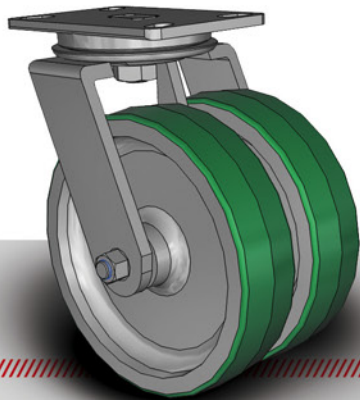

Download
3D CAD Models!

- **Quickly configure** models
- Download **native CAD formats**
- Download **datasheets**
- **Easily share** with your team

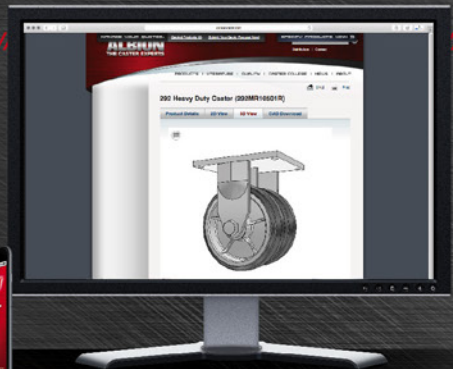

We work hard to ensure all specifications and part numbers are accurately represented throughout our catalog, however catalog specifications are subject to change without notice.

Colson Group USA © 2016 Albion Caster